

SEPTEMBER  
1948

RADIO-ELECTRONIC  
ENGINEERING  
EDITION

# RADIO & TELEVISION NEWS



HAMS SIMULATE EMERGENCY COMMUNICATIONS  
ON ANNUAL FIELD DAY

PAGE 41

TELEVISION  
ASSEMBLY CO.

520 Sq. In. PICTURE  
20" x 26"

# PROJECTION TELEVISION

IN ASSEMBLY FORM FOR CUSTOM INSTALLATIONS

- FULL 520 Sq. In. PICTURE 20" x 26"
- EXTRA HIGH BRILLIANCE
- SUPERB RESOLUTION
- UNEXCELLED ANGULAR VIEWING
- NO EYE-STRAIN WHATSOEVER

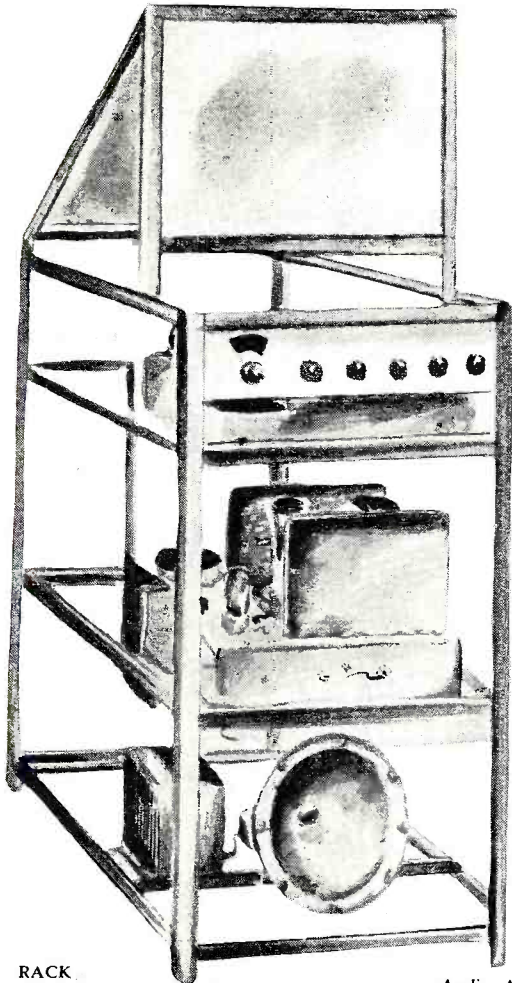

RACK  
DIMENSIONS

Height 48" Width 30" Depth 22"

*In line with its established policy, Television Assembly Co. permits YOU to charge your customer what YOU consider a just and reasonable price for your work in building and installing the Projection Television Assembly. A saving of over 50% for your customer . . . This is the Television Combination that can't be beat . . . anywhere.*

This screen is absolutely flat, precluding curvature distortion anywhere in the picture, giving you picture fidelity throughout the 520 square inch area. There is no color aberration: the picture tones are the true tones of black, grey and white, with no marring tints of blue-green or yellow. The picture is absolutely glare-free, giving you complete eye-comfort and pleasure, precluding eye-fatigue. For realism, clarity, definition and beauty, the pictures produced by this unit have no equal.

## ★ FEATURING ★

Precision Bausch & Lomb f. 1.9 Projection lens RCA 5TP4 Projection C. R. Tube Specially designed Pre-Wired 30KV Fly Back Power supply Eastman Kodak Projection Screen DuMont Inputuner . . . . . all channels and full FM Radio Pre-wired and Pre-tuned IF Picture and Sound strip 5 stages Picture IF ampl.

4.25 MC Bandwidth True FM Sound Ratio Detector Push-Pull Audio with 12" Heavy Duty PM Speaker 36 RCA Tubes Special folded di-pole and Reflector with 60 ft. lead in standard components through-out, conservatively rated, all components including mirror, screen, rack, schematic and wiring instructions.

## Another Incomparable Television Assembly Company First!!

Nothing else like it! Low voltage Power Supplies: two Low Voltage supplies to insure greater stability and regulation, producing a minimum of heat.

High Voltage Power Supply consists of 3 type 1B3GT as a Tripler using flyback deflection. Units operate efficiently with all voltage drops, maintaining a 3" x 4" picture of incandescent brilliance on the face of the RCA 5PT4 Tube, at a minimum of 27K.V.

IF Strip — consists of our perfected 13 tube IF Picture and Sound Strip, with 5 stages of Picture IF Amplification, giving 4.25 MC Bandwidth for maximum resolution.

Audio Amplifier: One Phase Inverter feeding into a pair of 6V6, push pull Class AB1, delivering approximately 8 watts undistorted output.

Optical System: consists of the Eastman Kodak Projection Screen, explicitly engineered to "concentrate" light; the renowned precision Bausch & Lomb f. 1.9 Projection Lens. The picture is projected through the lens onto a special aluminum-top coated mirror. The chassis employ wire cables for interconnection, to permit maximum accessibility for service.

Have your customers order from YOU a truly custom-built Projection Television receiver, engineered by Television Assembly Co., built and installed by you. Ideal for Theatres, Homes, Bars & Grills, Schools, Clubs & Lodges, Auditoriums.

**Guaranteed** All Television Assemblies are guaranteed to operate to your satisfaction when simple directions are followed.

*Ask your local National Parts Distributor for full details on this latest and biggest value in all television. Here is your opportunity to be in the Projection Television business and on your own terms. Don't miss it ACT NOW.*

**540 BUSHWICK AVENUE  
BROOKLYN 6, NEW YORK**

TELEVISION  
ASSEMBLY CO.

# I WILL SEND YOU BOTH FREE

64 PAGE BOOK

See how I give you practical experience building Radio circuits at home with BIG KITS OF PARTS I SEND. Illustrated books shows how you make extra money fixing Radios in spare time while still learning. Read letters from men I trained, telling what they are doing, earning. See the kind of fascinating jobs Radio, Television, Electronics offer. FREE with coupon below!

## ACTUAL RADIO LESSON

Same coupon entitles you to FREE lesson, "Getting Acquainted With Receiver Servicing." Discloses short-cuts Radio Repairmen use. Tells how "superhet" circuits work, three reasons why tubes fail, locating defects, repairing loudspeaker. Over 80 pictures, diagrams. FREE! Send coupon!

GETTING ACQUAINTED WITH RECEIVER SERVICING

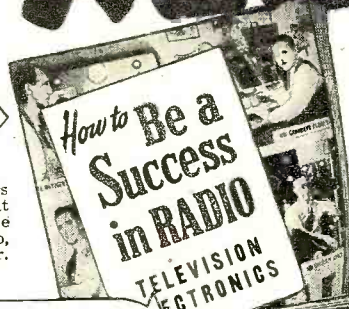

# See for yourself how I train you at home to BE A RADIO TECHNICIAN

Do you want a good-pay job in the fast-growing RADIO and Television-Electronics Industries? Or do you want to be boss of your own money-making Radio shop? Here is your opportunity!

I've trained hundreds of men to be Radio Technicians . . . men with no previous experience. I can do the same for you! My unique train-at-home method makes learning easy. I send you BIG KITS of Radio parts. All equipment yours to keep. You get practical Radio experience building, testing and experimenting with Radio circuits.

### Make EXTRA Money In Spare Time

The day you enroll, I start sending you EXTRA MONEY booklets. You LEARN Radio and Television principles from my easy-to-grasp, step-by-step illustrated lessons. You PRACTICE with parts I send. You USE your know-how to make extra money fixing neighbors' Radios in spare time. From here, it's a short step to your own shop or a good pay Radio job.

### N.R.I.—Trained Men Face Bright Future

Think of the money-making opportunities in Police, Aviation, Marine Radio, Broadcasting, Radio Manufacturing, Radio Repairs, Public Address work, etc. And think of even greater opportunities as Television, FM and Electronic devices become more and more available.

## You Build This MODERN RADIO with Parts I Send

Complete, powerful Radio receiver brings in local and distant stations. N. R. I. gives you ALL the Radio parts . . . speaker, tubes, chassis, transformer, sockets, loop antenna, etc.

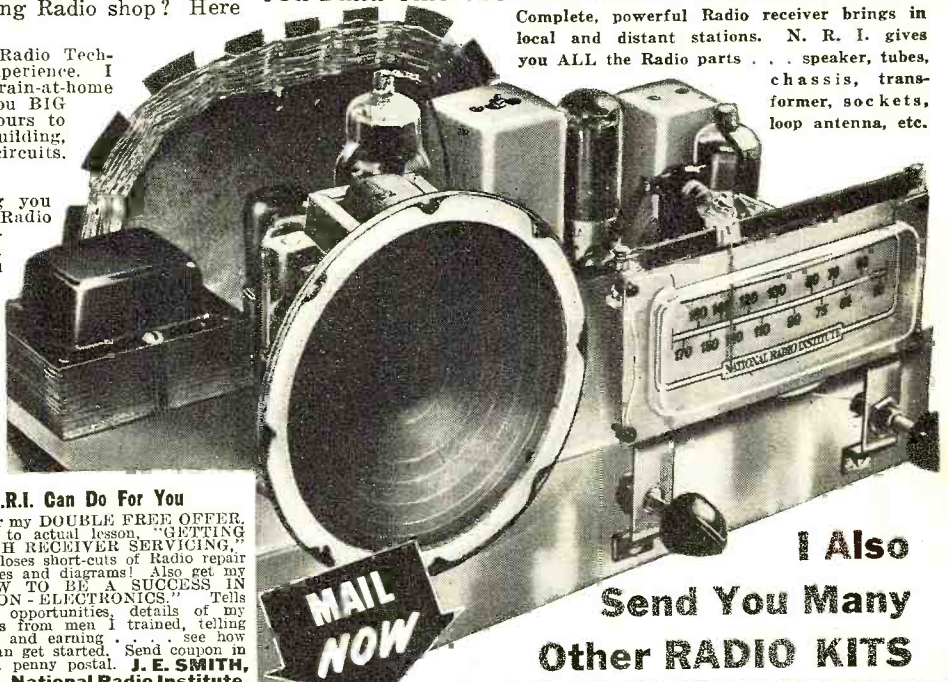

MAIL NOW

I Also Send You Many Other RADIO KITS

**VETERANS GET THIS TRAINING UNDER G. I. BILL**

### See What N.R.I. Can Do For You

Act now! Send for my DOUBLE FREE OFFER. Coupon entitles you to actual lesson, "GETTING ACQUAINTED WITH RECEIVER SERVICING," absolutely free. Discloses short-cuts of Radio repair men. Over 80 pictures and diagrams! Also get my 64-page book, "HOW TO BE A SUCCESS IN RADIO - TELEVISION - ELECTRONICS." Tells more about YOUR opportunities, details of my Course. Read letters from men I trained, telling what they are doing and earning. . . see how quickly, easily you can get started. Send coupon in envelope or paste on penny postal. **J. E. SMITH, Pres., Dept. SJR, National Radio Institute, Pioneer Home Study Radio School, Washington 9, D. C.**

### I TRAINED THESE MEN

Has Own Radio Business



"Now have two Radio shops, servicing about 200 sets a month. Highly successful our first full year." — ARLEY STUDYVIN, DeSoto, Missouri.

Extra Cash In Spare Time



"Earned enough spare time cash to pay for my Course by time I graduated. N. R. I. training is tops!" — ALEXANDER KISH, Carteret, New Jersey.

My Course Includes Training in **TELEVISION ELECTRONICS — FM**

## Actual Lesson and 64 Page Book FREE

MR. J. E. SMITH, President, Dept. SJR National Radio Institute, Washington 9, D. C.

Mail me FREE Sample Lesson and 64-page book about how to win success in Radio and Television—Electronics. (No salesman will call. Please write plainly.)

Name..... Age.....

Address.....

City..... Zone..... Stat.....

Check If Veteran APPROVED FOR TRAINING UNDER G

Editor  
OLIVER READ, WSETI

Managing Editor  
WM. A. STOCKLIN

Technical Editor  
H. S. RENNE, EX-W8PTS

Associate Editors  
RAY FRANK, W9JU

P. B. HOEFER

E. HITZEL

S. KRUMBACH

Staff Artist  
R. S. KUPIACK

Advertising Manager  
L. L. OSTEN

Midwestern Advertising Manager  
JOHN A. RONAN, JR.

Art Director  
HERMAN R. BOLLIN



COVER PHOTO: The Twelfth Annual Field Day found groups of ham enthusiasts busy at their rigs. W9FIB and W9JU operate the TBS-50 transmitter while Eleanor Hitzel and W9JU's XYL assist. (Staff Photograph)

Chairman of the Board and Publisher  
WILLIAM B. ZIFF

President  
B. G. DAVIS

Secretary-Treasurer  
ARTHUR T. PULLEN

Vice-Presidents  
GEORGE BERNER  
Advertising and Sales Director

MICHAEL H. FROELICH  
Dir. Eastern Div.

H. J. MORGANROTH  
Production Director

H. G. STRONG  
Circulation Director

BRANCH OFFICES  
NEW YORK (11)  
Empire State Bldg., WI 7-0400

LOS ANGELES (14)  
815 S. Hill St., TUcker 9213  
Manager, WILLIAM L. PINNEY

TORONTO  
21 King Street, East  
ASSOCIATED WITH  
Ziff Davis, Ltd., Grampians Bldg.  
Western Gate, London, England

# RADIO & TELEVISION NEWS

First in radio-electronics

Average Paid Circulation over 185,000

Radio News Trade Mark Reg. U.S. Pat. Office No. 378427

## CONTENTS

SEPTEMBER, 1948

Microwave Plumbing Replaces Circuitry.....	Samuel Freedman	35
A Portable, Lightweight, I-Tube Stroboscope.....	Rufus P. Turner, W1AY	38
Something New in Color Television.....	Ralph Crosman	40
Hams Simulate Emergency Communications on Annual Field Day.....		41
The Taylor "Super-Modulation" Principle.....	R. E. Taylor	42
Efficient Servicing.....	J. E. Cunningham	45
A Miniature Tube High Fidelity Amplifier.....	Wm. Boyer & Emory Toops	46
The Recording and Reproduction of Sound (Part 19).....	Oliver Read	48
Build Your Own Communications Receiver (Part 2).....	J. T. Goode	50
Wide Range Speaker Systems.....	J. Carlisle Hoadley	53
New Television Power Supplies Use Selenium Rectifiers.....	George Eannarino	54
Confessions of a Surplus Hound.....	Cecil R. Nelin	57
Trap Circuits for Television Receivers.....		58
Gain Measuring Test Unit.....	W. E. Norman	61
A Low Cost Volt-Ohmmeter.....	Thomas R. Lawson, Jr.	64
Mac's Radio Service Shop.....	John T. Frye	66
Modern Television Receivers (Part 6).....	Milton S. Kiver	67
The Audio Engineering Society.....	Lewis S. Goodfriend	82
Radio Quiz.....	Ed. Bukstein	148

## DEPARTMENTS

For the Record.....	The Editor	8	What's New in Radio.....	76
Spot Radio News.....		18	Technical Books.....	88
Within the Industry.....		26	New Receivers.....	152
Short-Wave.....	K. R. Boord	60	AFCA News.....	166
Manufacturers' Literature.....		172		



COPYRIGHT 1948  
ZIFF-DAVIS PUBLISHING COMPANY  
185 North Wabash Ave., Chicago 1, Ill.  
VOLUME 40 • NUMBER 3



RADIO & TELEVISION NEWS is published monthly by the Ziff-Davis Publishing Company, 185 N. Wabash Ave., Chicago 1, Ill. Subscription Rates: in U. S. and Canada \$4.00 (12 issues); single copies 35 cents; in Mexico, South and Central America, and U.S. Possessions, \$4.00 (12 issues); in British Empire, \$5.00 (12 issues)—all other foreign countries \$5.00 (12 issues). Subscribers should allow at least 2 weeks for change of address. All communications about subscriptions should be addressed to: Director of Circulation, 185 N. Wabash Ave., Chicago 1, Ill. Entered as second class matter July 21, 1948, at the Post Office, Chicago, Illinois, under the Act of March 3, 1879. Payment made at our current rates, covers all authors', contributors' or contestants' rights, title, and interest in and to accepted material, including photographs and drawings.

RADIO & TELEVISION NEWS

# Assembly Line . . . for radio chassis or . . . TV ??

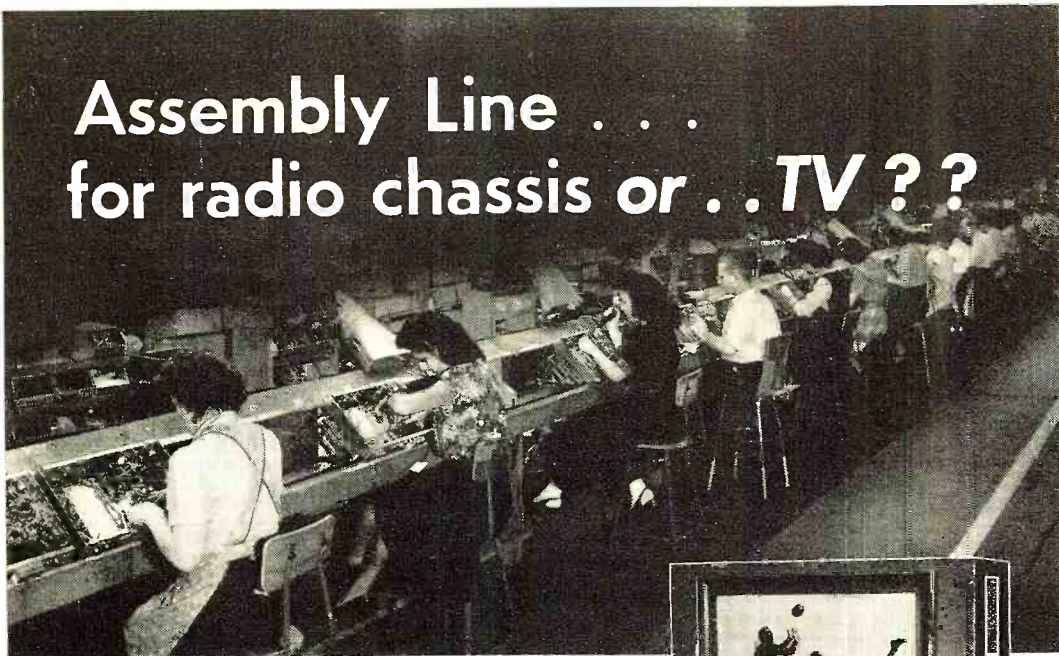

It's sometimes hard to tell. In the RF and IF sections there's very little difference.

That's why it was easy for hallicrafters to add television to their line. Long years of high-frequency "know-how" in the Amateur field now bring you precision television at amazingly low prices.

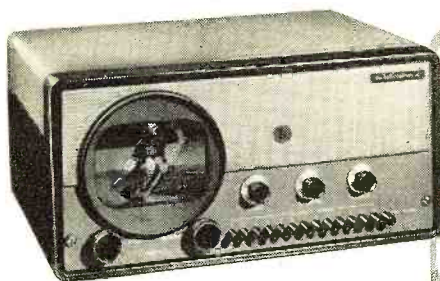
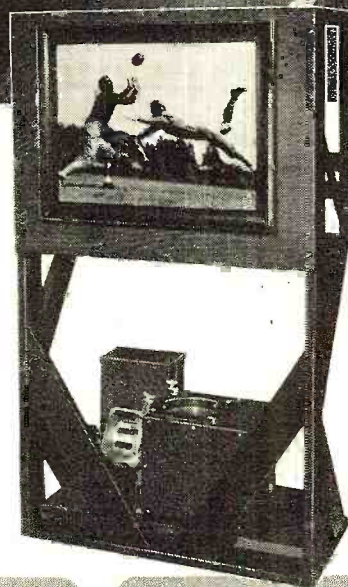

**Model T-54 \$16950**

7-inch direct view; push-button tuning on all 12 channels. 19 tubes plus cathode ray tube and 3 rectifiers. Size 20" x 9 3/4" x 18". Write for folder S-207C

**Model T-60 \$59500**

16" x 12" screen; 12-channel push-button tuning. 22 tubes plus cathode ray tube and 3 rectifiers. Size 44 1/2" x 24" x 14". Write for folder S-208C

## The hallicrafters Co.

4401 W. FIFTH AVE., CHICAGO 24, ILLINOIS

WORLD'S LEADING MANUFACTURERS OF PRECISION RADIO AND TELEVISION EQUIPMENT

BILL

# Here's Real News!

## AC-DC TELEVISION MADE POSSIBLE FOR THE FIRST TIME

### Trend Is to New Low Prices for Lighter, Smaller 7" and 10" TV Sets

### SMALL, COMPACT POWER SUPPLY HANDLES AM-FM-TV COMBINATION

#### All Resulting from Federal's New Miniature 500 MA Selenium Rectifier

YES, this mighty miniature makes big television headlines! Its hitherto unapproached power-handling capacity promises a virtual revolution in television design. Think of the possibilities... a single Selenium Rectifier power supply able to handle an AM-FM-TV combination... AC-DC television... drastic reductions in size, weight and price of 7" and 10" sets.

These important savings result not only from the small size of this new Federal Miniature Selenium Rectifier, but its elimination of large, heavy, expensive transformers and expendable rectifier tubes in the power supply. What's more, it can be used with smaller condensers with lower voltage ratings.

Here's the diagram of a suggested circuit for an AC-DC power supply for 7" and 10" electrostatic deflection tubes.



438D3428A

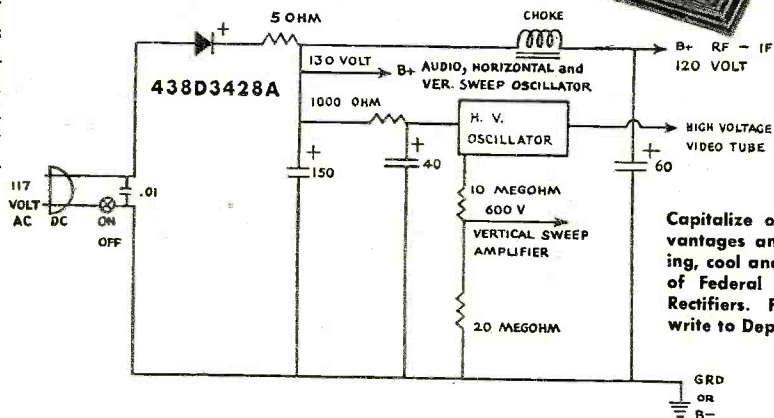

Capitalize on these design advantages and the instant starting, cool and efficient operation of Federal Miniature Selenium Rectifiers. For technical data, write to Department F259.



## Federal Telephone and Radio Corporation

SELENIUM and INTELIN DIVISION, 900 Passaic Ave., East Newark, New Jersey

In Canada: - Federal Electric Manufacturing Company, Ltd., Montreal, P. Q.  
Export Distributors: International Standard Electric Corp. 67 Broad St., N. Y.

RADIO & TELEVISION NEWS

HOW TO MAKE MONEY  
in  
RADIO  
ELECTRONICS  
TELEVISION

GET THESE 2 BIG BOOKS

**FREE**

IF YOU  
WANT TO LEARN

**RADIO!**



**FRANK L. SPRAYBERRY**  
famous Radio teacher of hundreds  
of successful Radio men.

**I TRAIN YOU RIGHT BY SENDING YOU 8 BIG KITS OF  
RADIO EQUIPMENT INCLUDING A POWERFUL 6 TUBE  
SUPERHET RECEIVER AND 16 RANGE TEST METER!**

Radio job. Just mail the coupon for a FREE Sample Lesson and my big FREE book, "How To Make Money In Radio, Electronics, Television." It tells how I train you at home during spare hours by putting you to work building, testing, repairing Radio equipment. The Sprayberry Course teaches you Radio by working with 8 big kits of Radio parts I supply. You build a powerful 6 tube superhet Radio, a 16-range test meter, perform over 175 interesting, PRACTICAL experiments. My lessons are easy and interesting—you need no previous experience in Radio. I start you at the beginning... and give you valuable "bench" experience that sticks with you.

Soon after you start I send you my famous BUSINESS BUILDERS that help you earn EXTRA CASH getting and doing neighborhood Radio Service jobs while learning. You couldn't pick a better time to get into Radio. The Radio Repair Business is booming! Good Radio Service and Repair Shops are needed everywhere as millions of new sets are in use. Trained men are wanted for opportunities in Police, Aviation and Marine Radio, F.M. and Standard Broadcasting and Television. Manufacturers are looking for men who know Radio as production reaches new peaks. GET THE FACTS ABOUT YOUR FUTURE IN RADIO. MAIL THE COUPON TODAY for my FREE BOOKS.

**LEARN HOW TO BUILD-TEST-REPAIR RADIOS By Working with YOUR HANDS!**

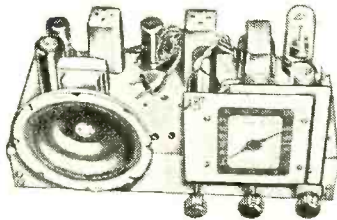

You really learn Radio the PRACTICAL way... when you build this big, powerful 6-tube Superhet Radio from parts I send you.

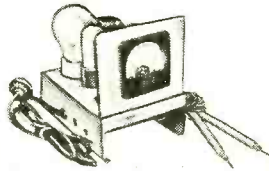

give you a fine, moving coil type Meter—with parts for a complete analyzer and Circuit Continuity Tester. "Trouble-shoot" with professional accuracy.

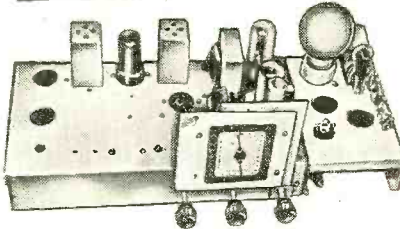

You don't have to buy expensive ready-made equipment. You get valuable experience building this Signal Generator and Multi-purpose Tester.

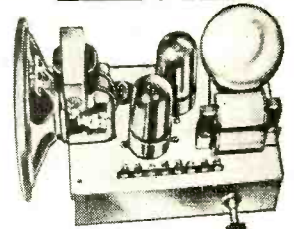

You construct this rectifier and filter, resistor and condenser tester, and really get on the Practical end of Radio.

**LOW COST RADIO TRAINING STUDY AT HOME IN SPARE HOURS**



Trained Radio men can step into their own profitable Radio Service Shop—or



New developments are constantly opening new big pay job opportunities in Radio.

Sprayberry Training costs surprisingly little! Easy monthly payments, if desired. Everything you need is furnished—nothing else to buy. With Sprayberry Training to back you up, you will be able to step into your own profitable Radio Service Business or go on to a big opportunity in Radio, Electronics or Television. The equipment I send you is yours "for keeps"—to use in your business or job. I have trained thousands of successful Radio men—and I can help you, too. Get the facts about Sprayberry Training—it's your first step to success, security and a bigger income in a field where you'll really enjoy your work. Fill out and mail coupon TODAY. I'll rush my two FREE books to you by return mail.

**VETERANS:** Approved for G. I. Training under Public Laws 16 and 346.

**Sprayberry Academy of Radio**

F. L. SPRAYBERRY, President  
Room 2598, Sprayberry Bldg., Pueblo, Colorado

**RUSH COUPON Today!**

**SPRAYBERRY ACADEMY OF RADIO**  
F. L. SPRAYBERRY, President  
Room 2598, Sprayberry Bldg., Pueblo, Colorado  
Please rush my FREE copies of "How To Make Money In Radio, Electronics and Television" and "How To Read Radio Diagrams and Symbols." No salesman will call.

Name \_\_\_\_\_ Age \_\_\_\_\_

Address \_\_\_\_\_

City and Zone \_\_\_\_\_ State \_\_\_\_\_

CHECK HERE IF A VETERAN

(Mail in an Envelope or Paste on Penny Postcard)

September, 1948

For "Hard-to-Reach" Jobs  
 And Regular Soldering, Too  
 New WELLER ALL-PURPOSE

SOLDERING GUN

When the job's deep down in the chassis and there's wiring in the way—simplify your work with a Weller Soldering Gun. Specially designed for radio, television and appliance service men, it's longer reach, flexible loop tip slips easily between wiring, right to the spot. You see where you're going too, for the Weller Solderlite is pre-focused to show you the way. And once you've made contact, there's no waiting for heat. Five-second heating is controlled by the automatic trigger switch.



Another advantage! The Weller Gun is a complete, self-contained unit. The transformer is *not separate but built-in*—and since it heats only when the trigger is pulled, retinning or redressing is unnecessary when properly used with genuine Weller Tips. There's no need to unplug the gun when not in use. Your Weller Gun saves hours and dollars, and will pay for itself in a few months.

Want this handful of soldering convenience? Then see your distributor. Or, if you wish, write for bulletin direct. For radio service work, the efficient 8" model—DX-8 with dual heat is recommended; or the 4" types S-107 single heat and D-207 dual heat.

**WELLER**  
 MANUFACTURING COMPANY  
 810 Packer Street • Easton, Pa.

For the **RECORD.**

BY THE EDITOR

AMATEUR RADIO NEEDS NEW BLOOD

IT HAS been over two long years since the RMA (Radio Manufacturers Association) formed its *Amateur Radio Committee* to study the many problems confronting ham radio. The initial interest of its members ran high and those attending the first meeting, including ourselves as visitors, made many suggestions on what could and should be done to help offset the rising age limit of the average radio amateur.

A proposal was made to the *Committee* by RADIO NEWS for launching a campaign for "new ham blood" in the interest of teenagers, returning Vets, Signal Corps personnel, and communications-minded Scouts. Such a campaign, we felt, would help stabilize the average age limit of the active ham and it would be potent ammunition in fighting juvenile delinquency by encouraging this fascinating hobby.

Industry too would benefit from the sale of amateur equipment to new licensees who would, without a backlog of equipment, "start from scratch." The average Ham spends about \$125.00 yearly for new equipment or replacements, and the average amateur has in his equipment an investment of approximately \$588.00.

Of greatest value would be a new crop of radio operators to bolster our Communications System in the event of another emergency.

With so much at stake, one would expect the Committee to at least make a feeble attempt to formulate and take some plan of action. What happened? Nothing!!

As far as we know the "Committee," which included members of the *League* staff, has apparently gone into retirement. Now over two years later, we discover that the age of the active radio amateur has increased from a prewar average of 29-30 to the current figure of nearly 34 years. The RMA Convention, held recently didn't even mention the *Amateur Committee* in its annual report in spite of the very excellent progress made by other Committees, particularly the Service Committee whose members unani-

mously recommended that the practice of the manufacturer guaranteeing television service for one year should be abolished and that the regular radio serviceman should handle said service with the regular 90 day manufacturer's guarantee.

We don't think the RMA alone is responsible for the failure of the Amateur Committee to function. We do feel that the initial enthusiasm on the part of those who *could and should do something about it* has dwindled. This fact alone should spotlight the danger to the future security of amateur radio to those who are evidently content to sit back and wait for the storm clouds to gather before again coming to life.

We are beginning to wonder if our A.R.R.L. is cognizant of the danger of the steady rise in the average age of the American ham. We would like to see some of Mr. Bailey's sincere interest in young blood bear fruit. We have talked to enough *League* "ex-officios" to realize that too much is taken for granted in the welfare of the ham and that some of our *League Directors* are apparently doing nothing that might jeopardize their *status quo*.

No one individual can solve our problem. No organization can do it alone, but they sure could help.

No Committee, especially a dead one, can promote or launch a campaign for new ham blood.

We, as Hams, cannot take a selfish viewpoint in our hobby. The lad across the street has an equal claim to the channels we cherish (and try to hold), and we cannot claim that we are too crowded to accommodate new stations, simply because we have not yet learned how to use our existing channels most effectively.

Our best investment in the future security of Amateur Radio is for every Ham to personally sponsor an interested teenager and to encourage him in Ham radio. He will be repaid many times and will greatly help to reinvigorate amateur radio as a young man's game, as well as one for the old-timers.....O. R.



# ALLIED has Everything New in Radio!

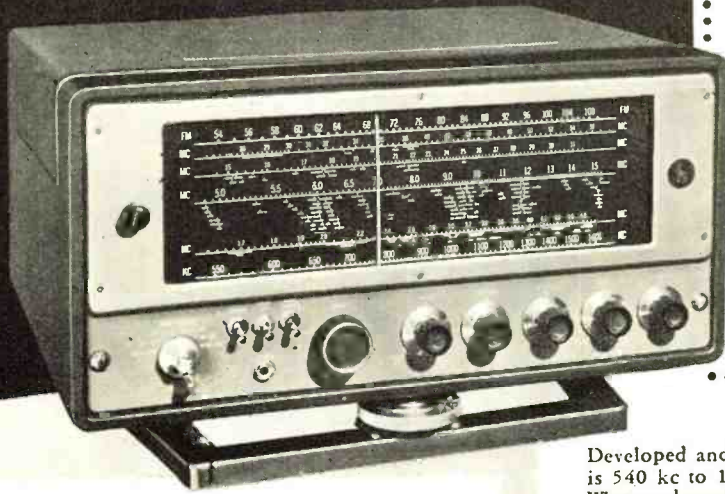

## NEW hallicrafters SX-62 RECEIVER

Designed for Short Wave  
Listeners and DX Fans

### Television by hallicrafters



### 505 TELEVISION TABLE MODEL

The immensely popular direct-viewing Hallicrafters TV receiver in a distinctively styled wood table model cabinet. Here's perfected, clear, sharp, bright Television at amazingly low cost. Provides a brilliant picture 5 3/4" long by 4" high—a full 23 sq. inch picture area. Easy to operate: push-button station selection, simplified contrast control, easy horizontal and vertical framing. Has built-in 6" x 4" oval PM speaker; excellent sound. Overall size: 20 1/2" long, 11" high, 17" deep. For 105-125 volts, 50-60 cycles AC. Complete with tubes. Shpg. wt., 45 lbs. **\$17950**  
97-803. NET, f.o.b. Chicago .....  
Terms: \$35.90 down, \$12.68 monthly for 12 months.  
*Famous Model T-54.* Same as above, but in furniture steel cabinet, finished in rich silver-gray.  
97-800. NET, f.o.b. Chicago ..... **\$169.50**  
Terms: \$33.90 down, \$11.98 monthly for 12 months.

Developed and built especially for the SWL. Total tuning range is 540 kc to 110 mc, continuously, covering world-wide Short-Wave and special services, broadcast, and all FM channels between 27 mc and 110 mc. Features: professional slide-rule dial with foreign Short-Wave stations and all services (marine, aviation, etc.) located on the dial; 500 kc crystal calibrator; pointer adjustment to set receiver on exact frequency; single knob tuning, 60 to 1 tuning ratio; each band separately illuminated; series type ANL; 4-position tone control; high-fidelity audio system; 8 watts output; dual IF channels; six-step selectivity; crystal filter; record-player input—plus a host of other desirable features. In handsome steel cabinet, 20" x 10 1/4" x 16". For 105-125 volts, 50-60 cycle AC. Complete with tubes. Shpg. wt., 65 lbs.

- 97-585. SX-62. NET, f.o.b. Chicago ..... **\$24950**  
Terms: \$49.90 down, \$17.63 monthly for 12 months.  
97-780. R-42 Speaker. Bass-reflex type, in matching metal cabinet. Shpg. wt., 20 lbs. NET ..... **\$34.50**  
97-568. B-42 Tilt-Base. Chrome finished. Shpg. wt., 6 lbs. NET ..... **\$7.50**

### There's Only ONE COMPLETE Radio Buying Guide—It's ALLIED'S CATALOG!

Get the Radio Buying Guide that's used by thousands of expert servicemen, engineers, soundmen, Amateurs, builders and experimenters! Radio's biggest catalog brings you the widest selections of the newest and finest equipment, at money-saving low prices. Get every buying advantage at ALLIED—speedy, expert shipment, the personal attention of seasoned radio experts—complete satisfaction on every order. Get your ALLIED Catalog today!



172 VALUE-PACKED  
PAGES. SEND FOR IT!

**FREE**

THE WORLD'S  
LARGEST  
RADIO  
SUPPLY  
HOUSE . . .



ALLIED RADIO CORP.  
833 W. Jackson Blvd., Dept. 1-J-8  
Chicago 7, Illinois

- Send FREE 172-Page ALLIED Catalog.
- Enter order for Hallicrafters Model.....
- Enclosed \$.....  Full Payment
- Part Payment (Balance C.O.D.)
- Send ALLIED Easy Payment Plan details and order blank.

Name.....

Address.....

City..... Zone..... State.....

**"We show customers we're equipped with Factory Information"**

*Says:* H. A. WENZEL

H. A. WENZEL RADIO SERVICE, Quincy, Ill.

"Our newly designed bench was planned for use in our show window. Tools are behind swinging panels, but not our 17 Rider Manuals. They're on display. We want to show customers we are equipped with factory information on any make or

model receiver they bring us for repair. "We keep our Rider Manuals at our fingertips as they are an important part of our servicing procedure. Speeding up diagnosis, they're important to our servicing profits too."

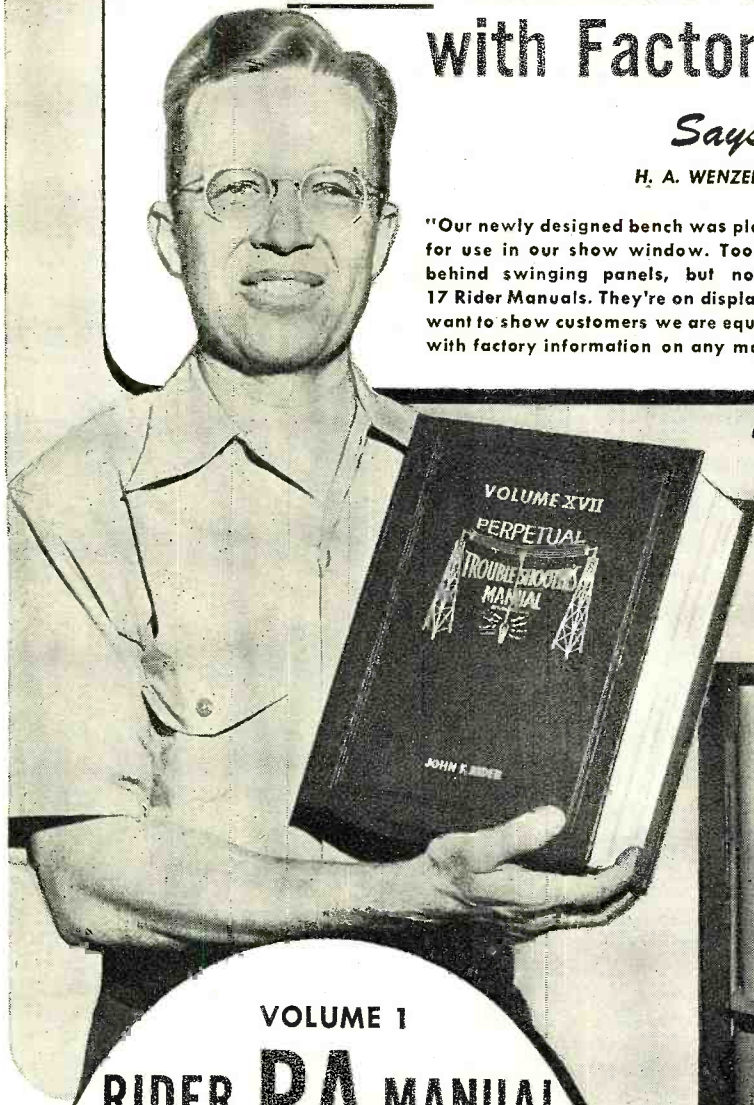

**You NEED ALL 17 RIDER MANUALS**

Volume XVII . . .	\$16.50	Abridged Manuals I to V (one vol.) . . .	\$19.80
Volume XVI . . .	8.40	Record Changers and Recorders . . .	9.00
Volume XV . . .	19.80	Master Index, covering Manuals, Vols. I to XV, 1.50	
Volume XIV to VII (ea. vol.) . . .	16.50		
Volume VI . . .	12.50		

**ORDER - FROM YOUR JOBBER - TODAY!**



VOLUME 1  
**RIDER PA MANUAL**

**OUT IN SEPTEMBER**

The first industry-wide service manual covering amplifying systems produced from 1938 to date, by more than 135 manufacturers. Schematics, voltage data, resistance values, capacity values, parts lists, etc. Separate "HOW IT WORKS" book explains the theory of various designs employed in different types of amplifier systems, the servicing of PA systems, using sine wave and square wave means of checking, methods of rapidly locating faults. Everything you need.

Approx. 2000 Pages . . . \$18.00

**ORDER YOURS TODAY!**

VOL. 1 JUST OUT

**RIDER**

*Television* **MANUAL**

**Establishing Sales Records!**

Contains circuit descriptions, adjustment of various trimmers, traps, transformers, etc., voltage and resistance readings, alignment instructions, parts lists, schematics, patterns, chassis views, wave forms. Everything needed.

208-page "How It Works" book covers underlying theory of television. Transmission and reception, frequency standards, antennas, various portions of television receivers.



**OVER 1400 PAGES**  
(but the equivalent of 2000 pages)  
**PLUS, 2 Separate Books, "HOW IT WORKS" & INDEX Complete \$18.00**

**Television "HOW IT WORKS" Available Separately**

If television is not yet in your area, it will be soon. Here is theory you want. 208 pages . . . \$2.70

**RIDER MANUALS** *Mean* **SUCCESSFUL SERVICING**

JOHN F. RIDER PUBLISHER, Inc., 404 Fourth Avenue, New York 16. Export Agent: Rock International Corp., 13E. 40th St., N.Y.C. Cable ARLAB.

NOTE: The Mallory Radio Service Encyclopedia, 6th Edition, makes reference to only one source of Radio Receiver Schematics—Rider Manuals.

*Exceptionally*

**HIGH IN QUALITY  
LOW IN PRICE**



**AUDIO  
OSCILLATOR  
Beat Frequency  
Type YGA-4**

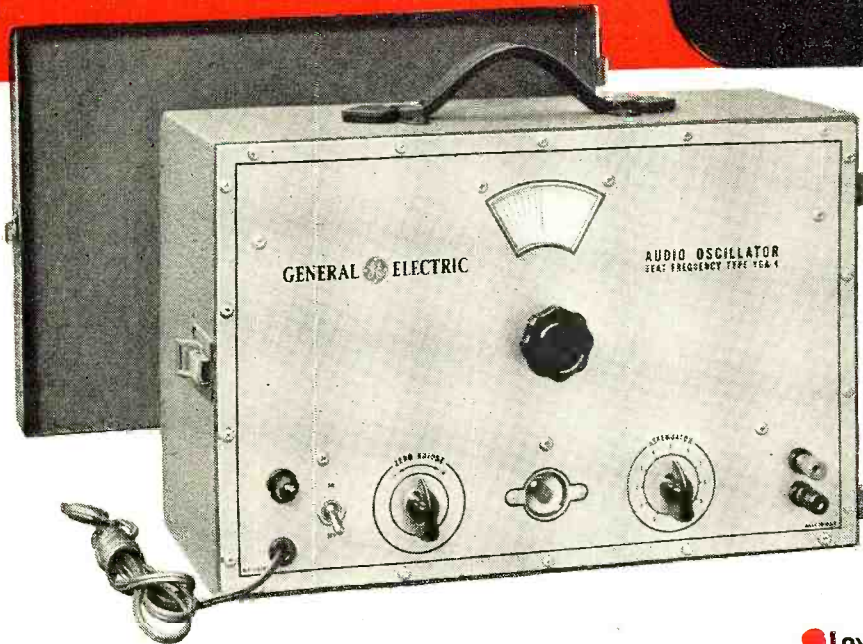

**S**ERVICEMEN, P.A. technicians, industrial laboratories and technical schools will find a wide variety of applications for this audio oscillator.

Covering the entire audio spectrum, from 25 to 15,000 cycles in one band, the YGA-4 permits extremely rapid checks of frequency response, loudspeaker or amplifier resonance, attenuation and overall performance. Check the features of the YGA-4—then order—today.

- Low Distortion Output... in one band over the entire audio spectrum.
- Stable BFO circuit enables the YGA-4 to deliver low distortion voltages which remain constant within  $\pm 1$  db over the frequency range, 50 to 15,000 cycles.
- Electron-ray tube for accurate calibration.
- Dial calibration inaccuracies caused by tube changes or rough handling can be corrected instantly by means of the "Zero Set" control and the electron-ray tube which indicates zero frequency between the two oscillators when the tuning dial is set to the "index" point. Thus, calibration accuracy can be maintained and checked at any time.
- Etched aluminum panel.
- Large, easy-to-read illuminated dial.
- Light, strong construction for easy portability.

For complete information on the G-E Audio Oscillator write:  
*General Electric Company, Electronics Park, Syracuse, N. Y.*

**GENERAL**  **ELECTRIC**

# Your new CRL parts catalog



20 pages of up-to-the-minute information

# NOW READY!

HERE IT IS— Centralab's complete new Distributor's Parts Catalog! 20 pages jam-packed with valuable technical information about Centralab's electronic components, including new prices and all new additions to the

Centralab line. Below are some of the new items which help make the CRL line one of the most complete in the service field. Ask your Centralab Distributor for your copy of this new Catalog— or write direct to us.

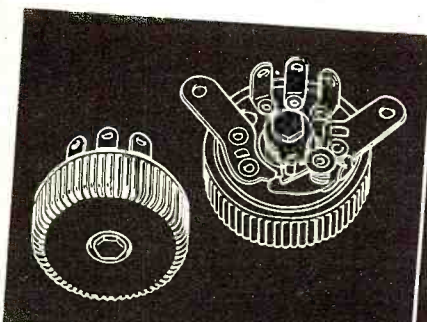

**MODEL "1" RADIOHMS:** No larger than a dime, specially designed for hearing aids, miniature receivers. With switch (right) or without. Rating 1/10 watt, 500 ohms — 5 megohms resistance.

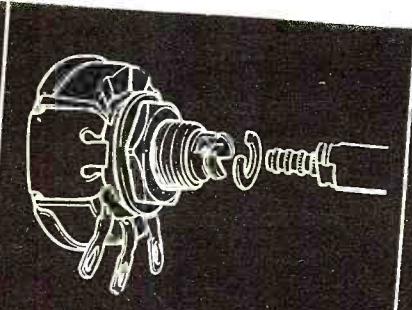

**"ADASHAFT" RADIOHMS:** Available in all sizes for all Model "M" volume control applications. Six types of shafts. Permits small stock to handle almost any kind of control replacement.

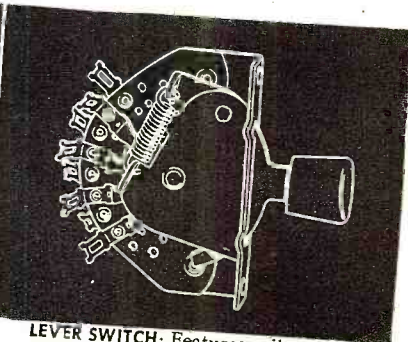

**LEVER SWITCH:** Features coil spring mechanism with index spring, replaceable without removal of switch from chassis. Life test — 150,000 cycles. 8 indexing combinations. Silver-plated clips and contacts.

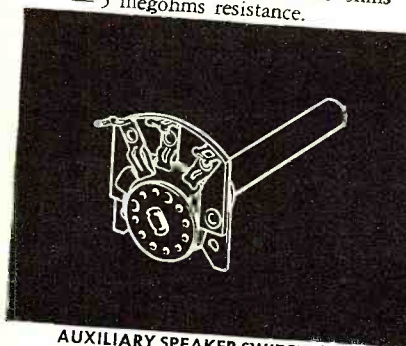

**AUXILIARY SPEAKER SWITCH:** Three position switch to provide remote control for auxiliary speaker installations. Life test — 10,000 cycles. Rating 6 watts.

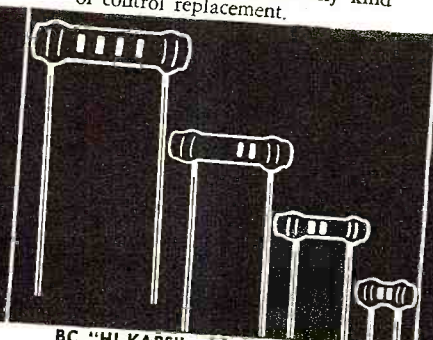

**BC "HI-KAPS":** Made of high dielectric Ceramic-X. Four basic tube sizes with capacity range from .000010 to .01 mfd. 500 WVDC. 1000 VDC flash test.

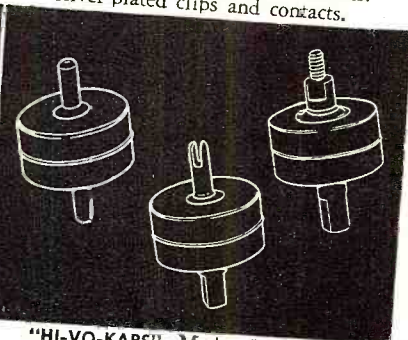

**"HI-VO-KAPS":** Made of Ceramic-X. Combine high voltage and small size for television and high voltage applications. 10,000 WVDC. 20,000 VDC. Capacity—500 mmf.

# Centralab

Division of GLOBE-UNION INC., Milwaukee

— at your CRL Distributor!

**PHILCO**  
*The Leader*

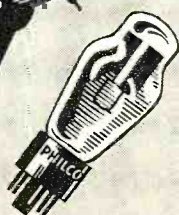

# Concentrate

**FOR GREATER PROFITS  
ON THE BRAND MORE OWNERS PREFER**

Philco leadership in radio sales for 18 straight years has built a market for replacement tubes, needles, and other parts far exceeding any other brand. That's the sound and solid reason for Philco's greater public acceptance. And that's why it's easier to *sell* genuine Philco replacements . . . why, too, it pays the dealer to concentrate on the complete Philco Universal parts line, for faster turn-over and more profits on invested capital. In addition, back of Philco products is the industry's greatest, year 'round advertising and merchandising campaign.

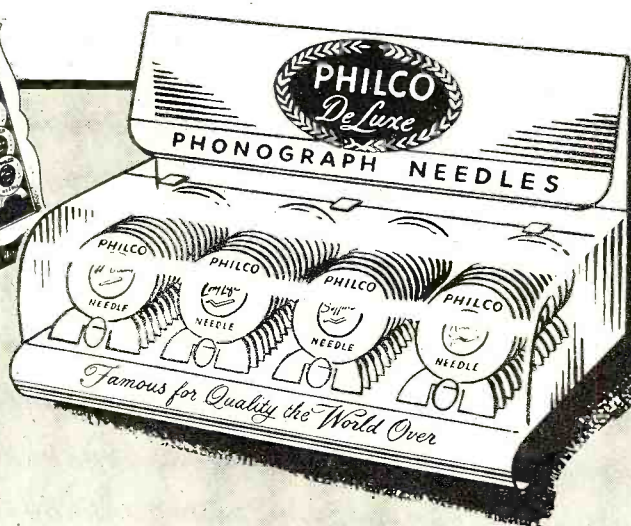
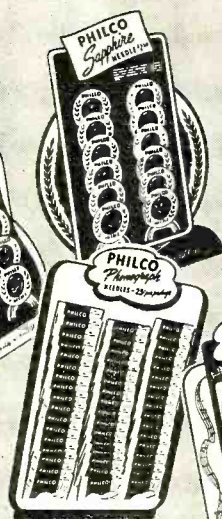

*Just Out...*

Sensational, new Philco tube and phonograph needle promotions. Get the complete facts at once from your Philco Distributor.

*Howard W. Sams*

presents the amazing  
**RADIO INDUSTRY  
 RED BOOK**  
 REPLACEMENT PARTS  
 BUYER'S GUIDE

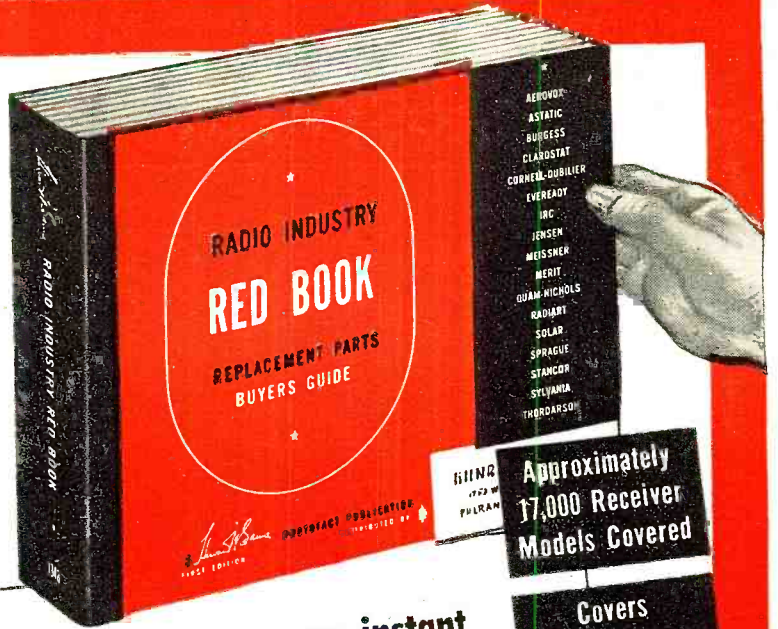

Approximately  
**17,000 Receiver  
 Models Covered**

Covers  
 Ten Years:  
**1938 to 1948**

Easy to Use:  
 All Data  
 Quick to Find

440 Pages  
 Smythe-bound  
 Opens Flat

**NOW** — a SINGLE authoritative volume that gives you instant reliable data on ALL replacement parts for thousands of popular radio receivers ... more useful data than in all other replacement parts guides and manuals **COMBINED** ...

**COMPLETE!**

The First Cooperative Industry Effort in Behalf of the Radio Service Technician

**FOR THE FIRST TIME IN RADIO HISTORY!**  
 All 9 Major Replacement Components Listed  
(not just 1 or 2 components)  
 17 Leading Parts Manufacturers Represented  
(not just 1 manufacturer)

**COMPLETE DATA ON ALL RECEIVER REPLACEMENT PARTS — ALL IN THIS ONE GREAT BOOK!**

Save time! Stop wasteful hunting! Get ALL the parts data you need—quickly—from this single book. NOW—for the first time—have all the replacement parts data you need—ALL in one single, authoritative volume. No more waste of valuable time searching through dozens of incomplete manuals and catalogs. The RED BOOK, first and only complete parts guide ever produced, covers approximately 17,000 radio models made from 1938 through 1947—10 full years. Lists parts made by 17 leading manufacturers—not just one! Gives you complete, accurate data on all 9 major replacement components—not just one or two! Clear, concise, easy-to-use—over 440 pages (8½" x 11") bound in a sturdy sewed cover, arranged alphabetically by manufacturer and model number for quick reference. Does away with confused collections of separate books and manuals—gives you complete information—PLUS data that cannot be found in any other source—at a fraction of the price you'd pay for the books it replaces. There's never been anything like it—absolutely indispensable for every service shop!

Only the RED BOOK gives you ALL this invaluable data. Here's everything you need to know about the replacement parts for the receivers you service daily. The RED BOOK gives you original manufacturers' parts numbers, proper replacement parts numbers and valuable installation notes on *Capacitors, Transformers, Controls, IF Coils* (including Peak Frequencies), *Speakers, Vibrators* and *Phono Cartridges, Tube and Dial Light* data includes number of tubes in each chassis, with type number for each tube, plus dial light numbers. *Battery* data includes replacement numbers on A, B, and AB packs. The following leading replacement parts manufacturers are represented in the RED BOOK:

- |                  |           |
|------------------|-----------|
| AEROVOX          | ASTATIC   |
| BURGESS          | CLAROSTAT |
| CORNELL-DUBILIER | IRC       |
| EVEREADY         | JENSEN    |
| MEISSNER         | MERIT     |
| QUAM-NICHOLS     | RADIART   |
| SOLAR            | SPRAGUE   |
| STANCOR          | SYLVANIA  |
| THORDARSON       |           |

18 months in preparation—over \$90,000 to produce. The RED BOOK is the product of thousands of man-hours spent in laboratory research and in cooperation with 17 participating manufacturers to produce the most complete, accurate, authoritative parts replacement guide ever published. Every bit of information in this amazing book has been painstakingly checked to insure maximum accuracy and usefulness. Over \$90,000 was spent to prepare the RED BOOK—the only book that brings you everything you need to know—every bit of replacement parts data you want to make your work easier and more profitable. You can't afford to be without the RED BOOK. It's the indispensable guide you'll use profitably every single day. Stop hunting for the right answers now—order your copy today.

**THE INDISPENSABLE RED BOOK ... ONLY ... \$3.95**

Mail This Order Form to Your Parts Jobber Today or send directly to HOWARD W. SAMS & CO., INC., 2924 E. Washington St., Indianapolis 7, Ind.

My (check) (money order) for \$..... enclosed.  
 Send.....RED BOOK(S) at \$3.95 per copy. (I understand that delivery will be made to me in September.)

Name.....  
 Address.....  
 City.....State.....

**BE SURE TO ORDER YOUR RED BOOK TODAY** →

**HOWARD W. SAMS & CO., INC.**  
 INDIANAPOLIS 7, INDIANA

# WELLS

## Radio-Electronic Components

### of *Guaranteed Quality*

#### 10 METER MOBILE ANTENNA

This 8 ft., 3 section mobile antenna is by far the best whip we've seen. The elements are copperplated, spring steel tubing, painted O.D. for protection against the weather. A 4" ceramic insulator reduces losses to a minimum. Long service under extreme vibration conditions is assured by the special molded rubber spring mounting. Positive co-ax connector at base. Mobile Antenna complete—only \$5.75 each.



#### BALLOONS AND KITES

These Army emergency balloons and box kites were made to carry long wire antennas. They are wonderful for field and DX work. Tubular canvas bag containing 2 4-ft. heavy duty balloons (packed in sealed cans), 2 hydrogen generators, an aluminum frame folding box kite, 300 ft. of stranded antenna wire—only \$9.95.

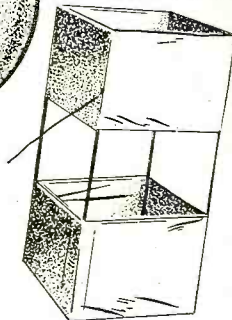
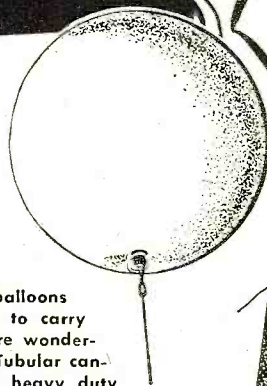

#### MICRO-SWITCHES AND SWITCHETTES

Our Micro-Switch and Switchette stock is one of the nation's largest. Listing 104A contains popular types at extremely attractive prices.

#### CO-AX CONNECTORS

Standard and British Type Co-axial Connectors in stock. Send for Listing 100A.

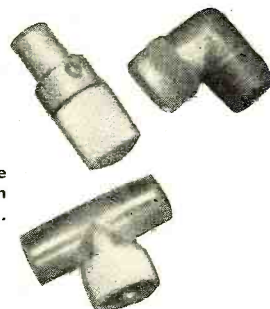

#### RELAYS

We have over a million relays in our warehouse. Huge quantities of hundreds of types make Wells the foremost source of equipment of this kind. Every relay is brand new and has been inspected, rated, individually boxed, and priced far below the market. Tell us your requirements or write for our Relay Catalog.

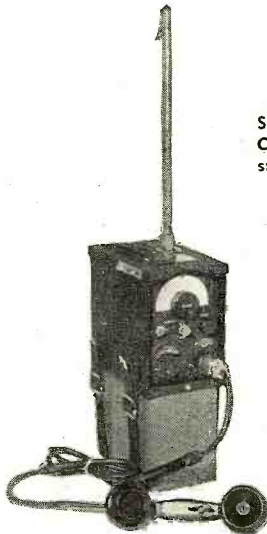
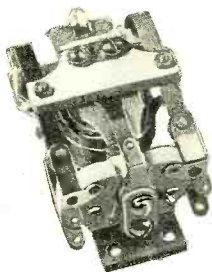

#### WALKIE TALKIES

A self-contained portable 10 and 6 meter transmitter-receiver. Wells Walkie-Talkies are shipped ready to operate complete with new batteries, telescoping antenna and handset. Rebuilt by the Government. Price only \$45.00. Parts, batteries and accessories for Walkie-Talkies and Handie Talkies available from stock. Write for listing No. 20.

#### WELLS TREMENDOUS STOCK INCLUDES A WIDE SELECTION OF THE FOLLOWING COMPONENTS:

Transmitting Tubes  
Mica Condensers  
Transmitting Condensers  
Wire & Cable

Transformers & Chokes  
Terminal Strips  
Wire Wound Resistors  
Volume Controls

Rheostats  
Dry Disc Rectifiers  
Tube Sockets  
Selector Switches

Manufacturers and Jobbers Write for Latest Complete Electronic Catalog

#### AMATEURS:

See us in Milwaukee at the ARRL Convention.  
Write for Amateur Catalog H400C



320 N. LA SALLE ST., DEPT. R-9; CHICAGO 10, ILL.

RADIO & TELEVISION NEWS



DESIGNED FOR THE BETTER SERVICE SHOP...

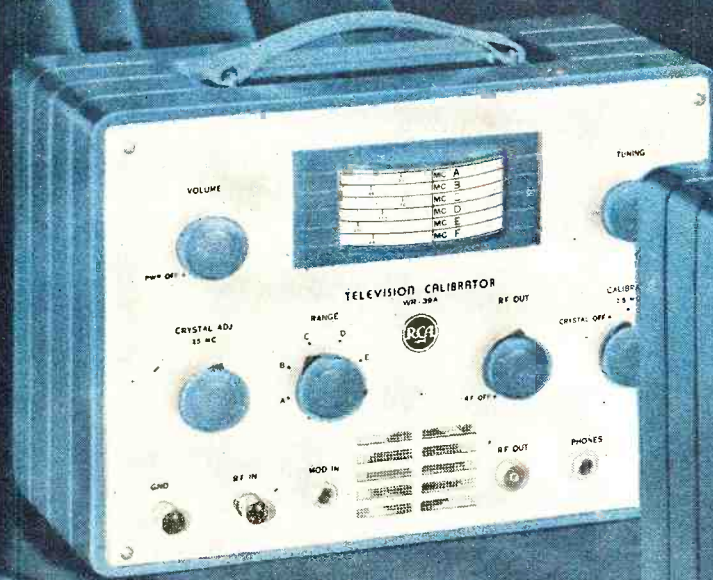

RCA WR-39A  
Television Calibrator

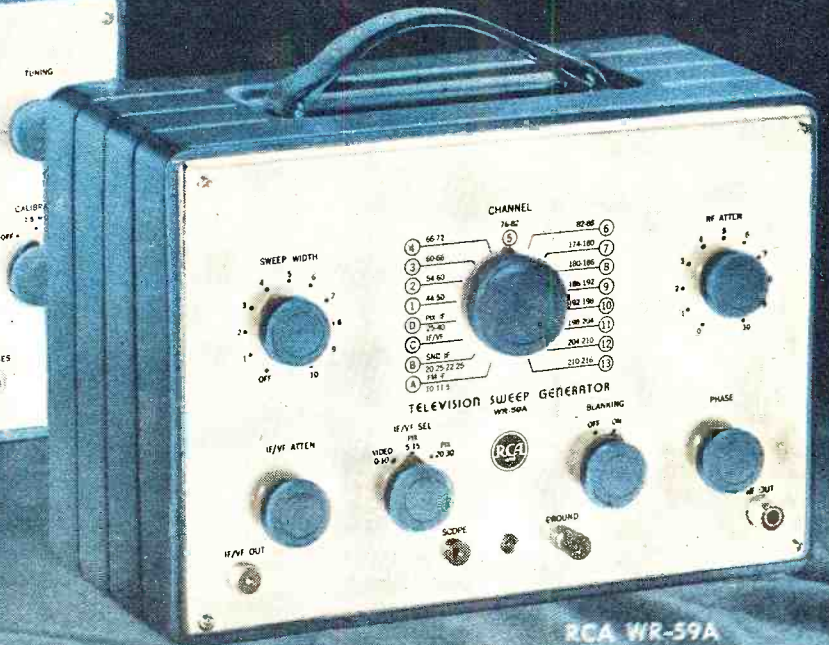

RCA WR-59A  
Television Sweep Generator

## The RCA TV DUO... your answer to precision television servicing

The RCA WR-39A Television Calibrator and WR-59A Television Sweep Generator are brand-new additions to RCA's comprehensive line of matched test units for modern AM, FM and TV servicing. They incorporate advanced design features reflecting the wide experience of RCA engineers in the field of television.

These companion units furnish *all basic signals* necessary for the rapid, precision servicing of television receivers. Flexibility, versatility, and accuracy are outstanding characteristics of each instrument individually and in combination. For alignment, the TV Duo can be used with any good oscilloscope.

The WR-39A Television Calibrator has two crystal oscillators for establishing the calibrator frequency. The marker oscillator operates on fundamental frequencies

in all bands, and provides markers at all TV frequencies. An easy-reading scale enables quick, crystal-harmonic identification, and a built-in speaker is provided for zero-beat indication.

The WR-59A Television Sweep Generator covers all broadcast television channels, TV- and FM-if bands. All ranges employ fundamental signals, are pre-set, and can be quickly selected by means of a band switch. Sweeps are provided for both 10.7-Mc. and 25.75-Mc. if bands, and for video channels to 10 Mc. Amplitude variation is less than 1 db. The piston attenuator has a maximum ratio of 20000/1.

See your RCA Test Equipment Distributor today for the full technical details or write RCA, Commercial Engineering, Section IX-60, Harrison, New Jersey.



Now — a complete service set-up... with RCA matched test units of your choice!

This beautifully finished all-steel laboratory-type rack is designed to accommodate any combination of six RCA matched test units you choose... to meet your various service requirements. Plenty of chassis room below for closeup work... or any unit can be readily removed for outside jobs. Six units in rack illustrated provide *complete* AM, FM and TV servicing set-up.

Available from your RCA Test Equipment Distributor



**RADIO CORPORATION of AMERICA**  
TEST AND MEASURING EQUIPMENT  
HARRISON, N. J.

FORECAST:

# Clear and Steady

THAT IS

**ATLAS SOUND  
PERFORMANCE**

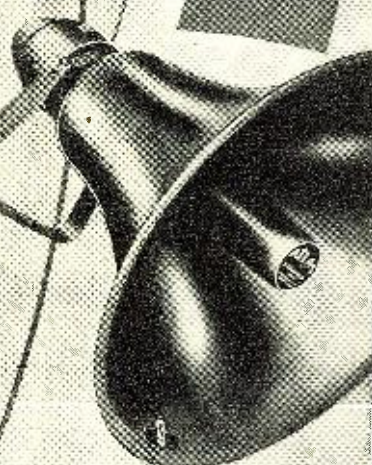

On land or sea . . . wherever Atlas Sound is used, you can count on unblemished, faithful performance. For a decade Atlas Sound has been noted for better Sound Equipment . . . now, the extra Alnico V Plus feature gives extra clarity, extra power, extra long-life.

**ATLAS  
SOUND CORP.**

1451 39th STREET  
BROOKLYN 18, N. Y.

# Spot Radio News

\* Presenting latest information on the Radio Industry.

By RADIO & TELEVISION NEWS'  
WASHINGTON EDITOR

## THE CITY OF BROTHERLY LOVE

. . . Philadelphia . . . became the nation's roaring sight and sound center during the recent national political conventions. The town teemed with telecasters, broadcasters, and public-address men, probably the greatest collection ever assembled in one area. All one-point-of-origination program records fell with the full weeks' daily schedules. The assortment of electronic gear used was a radio show, with every conceivable type of transmitting and receiving equipment around.

Television stole the show with an audience of 20,000,000 eyes from Boston to Richmond, Virginia, and in other key television cities throughout the country. Mirroring the moment-to-moment events with a pooled battery of cameras, every inch of the convention floor and balcony was scanned and beamed over an eighteen-station setup. Four cameras, each with a turret of four lenses, provided sixteen different angles of coverage in the hall. Two cameras to the left of the speaker's rostrum were manned by *NBC* and *DuMont* network engineers. A single camera to the right of the rostrum was operated by *CBS* boys. The fourth camera was mounted above the television announcer's booth near the left proscenium of the stage and controlled by *CBS* and other network men. *ABC* engineers operated a fifth camera outside of Convention Hall. A huge master control board, mounted to the left of the stage, was operated by the network engineers.

Televised images were fed to the control room of the *A. T. & T.* in the basement of the hall, where they were monitored and fed to a coaxial cable linked to the telephone company's terminal at Race Street, Philadelphia. From here they were sent via coaxial line to Baltimore, Washington, Richmond, Virginia, and Newark, New Jersey, and New York City.

In New York City, the images were fed to five TV stations on a *local-loop* arrangement. The *A. T. & T.* microwave station beamed the programs to Boston. Microwave setups also beamed the telecasts to Schenectady and New Haven, Conn.

Midwest and West Coast audiences were also able to look in on the convention by way of daily films, which were flown out to the TV stations.

Two types of film pickup were provided, direct and picture tube. The latter, with the television tube on the receiver supplying the images for filming, proved to be very effective.

Outside the hotels, where delegates and candidates were housed, TV cameras atop special mobile units did more scanning. The Bellevue-Stratford Hotel entrance and lobby looked like a sound stage set. The private rooms of the telecasters were strewn with monitors, patching boards, sync instruments, voltage stabilizers, scopes, cables, and cameras. With the teletype ticking away, phones jangling, field men cueing in and out, the network rooms often had a db. level of about 100, which thankfully dropped to 0 during interview time.

Television receivers were everywhere . . . in the ballroom headquarters of the candidates, and private rooms of delegates and convention officials. Market Street, Philadelphia, was a TV avenue. *Gimbel's*, on the street, had sets in nineteen windows. *Wanamaker's*, *Lit Brothers* and others all had TV sets in their windows. There were 150 sets operating in the Commercial Museum, located near Convention Hall, six manufacturers participating in the demonstration: *Farnsworth*, *General Electric*, *Motorola*, *Philco*, *RCA*, and *Westinghouse*.

Broadcasters had quite a field day, too, at Philly. Indoor and outdoor pickups were patched in a round-the-clock schedule. Commentators roved the city with "walkie-talkies." Around 70 microphones were in use at Convention Hall, with 48, set aside for the delegates, mounted on stanchions at each state setup.

Airborne television, "Stratovision," also played a telecasting role, during the Republican convention. During a test flight, telecasts were picked up from *WNBW*, Washington, D. C., and *WMAR-TV*, Baltimore, while circling over Pittsburgh at 25,000 feet and re-broadcast on channel 6, over an area of approximately 525 miles in diameter, reaching about nine states. At a special receiving point in Zanesville, Ohio, members of the press viewed the sight and sound demonstration. The signals were excellent.

The telecasts were made from a converted B-29, which housed a 5-kilowatt (peak) television transmitter, a 1-kilowatt FM sound transmitter,

**RADIO & TELEVISION NEWS**

# Do you want to

① Make Good Money?

② Have a Real Job?

③ Build for Future Security?

④ Have Your Own Business?

**THEN** get the facts about  
**OUR GREATEST OFFER**  
**IN 17 YEARS . . .** to help  
 you learn **TELEVISION..**  
**RADIO..ELECTRONICS**  
**IN YOUR OWN HOME**

Here's good news...big news...our **BIGGEST NEWS** in 17 years. Now you get and keep many shipments of Radio-Electronic parts... work over 200 "Learn-By-Doing" Experiments... build and keep a quality 6-tube "Super" Receiver with Magic Tuning Eye... build and keep a commercial-type, jewel-bearing Multi-Meter... use fascinating, instructive **HOME MOVIES** to help you grasp important points faster easier... get real Employment Service.

Mail coupon below. Get the complete story. See how we do BOTH--(1) Prepare, then (2) Help you get started in America's thrilling Radio-Television-Electronic field.

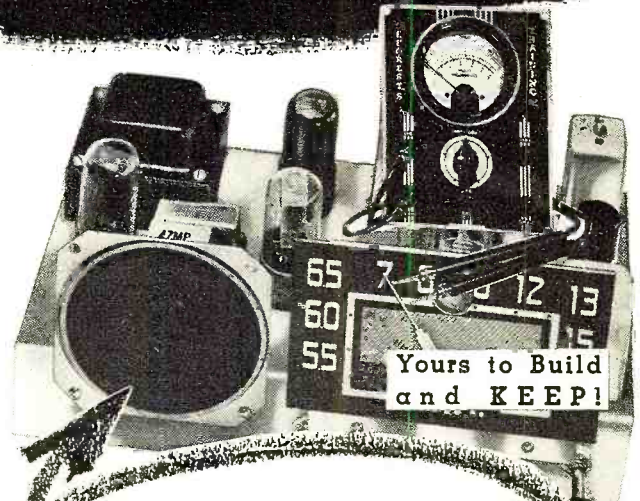

Using the many shipments of parts and assemblies (left), you build and keep this 6-tube "Superhet" Receiver and jewel-bearing Multi-Meter (above) to give you practical experience **AT HOME** in **ASSEMBLY... WIRING . . . SOLDERING . . . TESTING . . . TROUBLE SHOOTING!**



You **KEEP** all of this equipment... **WORK OVER 200 "LEARN-BY-DOING" PROJECTS!**

**TRAIN IN CHICAGO LABS**  
 If you prefer, you can get all of your training in our modern, well-equipped Chicago Laboratories. Write for all the details... there is no obligation.

**LEARN FASTER . . . EASIER**  
**RIGHT:** You receive the loan of a 16mm. Motion Picture Projector and many reels of "Learn-By-Seeing" film to speed your understanding of important points. You get this remarkably effective training aid **ONLY** from D.T.I.

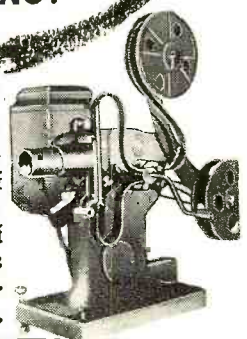

DeForest's Training, Inc.  
 2533 N. Ashland Ave., Dept. RN-E9  
 Chicago 14, Illinois

**MAIL TODAY**

Send me complete details showing how I may make my start in Radio-Electronics-Television. No obligation.

Name \_\_\_\_\_ Age \_\_\_\_\_  
 Address \_\_\_\_\_ Apt. \_\_\_\_\_  
 City \_\_\_\_\_ Zone \_\_\_\_\_ State \_\_\_\_\_

If under 16, check here for special information.  If a discharged veteran of World War II, check here,

**DeFOREST'S TRAINING, INC.**  
 CHICAGO, ILLINOIS  
 Associated with DeVry Corporation,  
 Builders of Electronic and Movie Equipment



## Provides Vast New Sales Fields For Dealers and Servicemen

The long-playing micro-groove records have opened a vast new sales field for Servicemen and Dealers. Hundreds of thousands of record enthusiasts are ready to buy the new records, but they must have a new pickup to play them. This is your big opportunity to "adapt" their present sets with the Shure "900MG." It is a tremendous market—an immediate, anxious, impatient market. Here are opportunities, sales, PROFITS! Think of the hundreds of phonograph users in your immediate area. You will render an outstanding service by using a Shure "900MG." It is unsurpassed for the most brilliant reproduction of music you have ever heard.

**AVAILABLE AT SHURE DISTRIBUTORS NOW!**

**Model 900MG Code: RUZUZ List Price — \$12.50**

(Shure Patents Issued and Pending. Licensed under Patents of Brush Development Co.)

**SHURE**

**SHURE BROTHERS, INC.**

*Microphones and Acoustic Devices*

255 W. HURON ST., CHICAGO 10, ILL. • CABLE ADDRESS: SHUREMICRO

20

modified RCA 630 TS receiver, Halli-crafters communications receiver, picture control panel with two picture monitors, 500 mc. link and standard television receiver, two program audio amplifiers, two pre-amp intercom and call amplifiers, monitor audio amplifiers, sideband filter (mounted in forward bomb bay), radar beacon equipment and power supplies, etc.

It was quite a test and indicated that the airborne method of telecasting and broadcasting had significant possibilities, introducing entirely new concepts in the art of transmission.

**THE POSTPONED TV** channel allocation sessions finally reached the hearing rooms during the last week of June, with legal and technical experts hammering away at the pros and cons of the FCC proposed allocation plan which would alter the channel setup in twenty areas. Some experts applauded the FCC plan. Others protested strongly declaring that expansion of the market areas would prompt interference, reduce signal strength possibilities and generally impair TV service. Former FCC commissioner T. A. M. Craven, who is now vice-president in charge of engineering for the Cowles' stations, supported the latter viewpoint, declaring that too few facilities will be distributed to too many communities, which will result in both inadequate competition and inequitable distribution.

A different approach to the allocation problem was submitted by *DuMont*, with eight additional channels provided, the channels to come from government service bands. Adoption of the plan would rest not only with FCC but the Interdepartment Radio Advisory Committee, who set up the government allocations. In the *DuMont* plan, the additional channels would come from either of two regions: 112-118 mc., 132-138 mc., 138-144 mc., 162-168 mc., 168-174 mc., 216-222 mc., 222-228 mc., 228-234 mc. or 162-168 mc., 168-174 mc., 221-227 mc., 227-233 mc., 233-239 mc., 239-245 mc., 245-251 mc., 251-257 mc. To accommodate these channels, the ham bands would have to be shifted from 235-240 to 234-239 mc., or 216-221 mc. *DuMont* engineers also suggested that the government might use a portion of the 475-980 mc. channel, now reserved for TV experimental work, in an exchange for channels in the 200-mc. region.

Covering the problem of co-channel operation, a major factor in the allocation plan, *DuMont* experts said that co-channel stations should be at least 180 miles apart in contrast to the FCC 150 mile separation proposal.

Testifying for *Eitel-McCullough's* Mount Diablo stations, O. H. Brown requested deletion of channel 12 in the Stockton, California, area, to permit operation of a 50 kw. TV transmitter on channel 13, which would be used in the main for developmental and test work.

*(Continued on page 112)*

**RADIO & TELEVISION NEWS**

YOU DO BETTER

YOUR CUSTOMERS DO BETTER

WE ALL DO BETTER!

How can you miss with Values like these?

THE HERITAGE—Matched twin speakers, exclusive Phantom Grilles, "Front Row" AM and long-range FM radio . . . pullout automatic record changer . . . ample storage space, add up to radio's biggest package for only \$189.50.



## That's THE NET OF OUR NEW DIRECT-DEALER RADIO AND TELEVISION MERCHANDISING PLAN

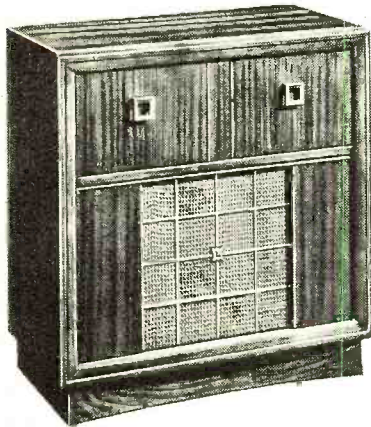

Take it from America's top retailers—no other radio and television franchise packs such merchandising power and provides such profit protection. You get better merchandise—exclusive "Front Row" performance and Aviation Quality win on any comparison. You offer better values—with low, direct-from-factory prices, you successfully compete with chains.

You make a better profit—an exclusive franchise protects you against price wars while national advertising directs all local prospects only to your door. Take the first step through this wide open door to a billion dollar market—get the whole big story. Do it today—this franchise is available to only one select dealer in each community.

### EXCLUSIVELY YOURS — ADVANTAGES NO OTHER RADIO-TELEVISION FRANCHISE COMBINES

- The appointment of only one dealer in each community • Direct factory-to-dealer shipments • Freight prepaid to destination • Low consumer prices competitive with national chains and mail order houses • Liberal dealer discounts • Nationally advertised retail prices protected by your exclusive franchise • Radio and television built to Bendix aviation quality standards • A complete line of radios and radio-phonographs including famous Bendix Long Range FM • The most advanced television created by the acknowledged leaders in radar and radio engineering • Consistent national advertising that builds store traffic for you • Compelling point-of-sale promotion helps • Special promotion models to meet competitors' "off-season" distress sales • Plus many new features to be announced.

THE WILTONDALE—With its 12-inch speaker, "all-front" control record changer, powerful AM-FM radio and FM dipole antenna, this brilliant beauty looks and performs better than models priced \$40.00 higher than \$209.95.

THE FIESTA—Provides the finest picture . . . occupies the least space . . . makes the best appearance of any television set near its price. Built-in antenna gives a picture without installation wait. Push button tuning covers all channels. Only \$329.95.

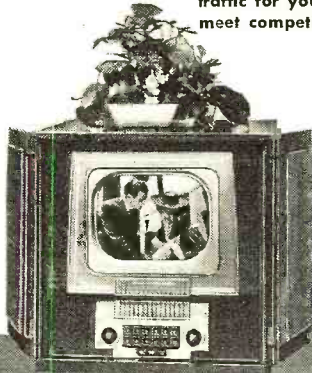

Write today for all the facts direct to Edward C. Bonia, General Sales Manager

THE PAGEANT—Big "eye-angle" picture. Famous long-range Bendix AM-FM radio. Automatic phonograph. Record storage. Heirloom quality cabinet. The best of everything for only \$599.50.

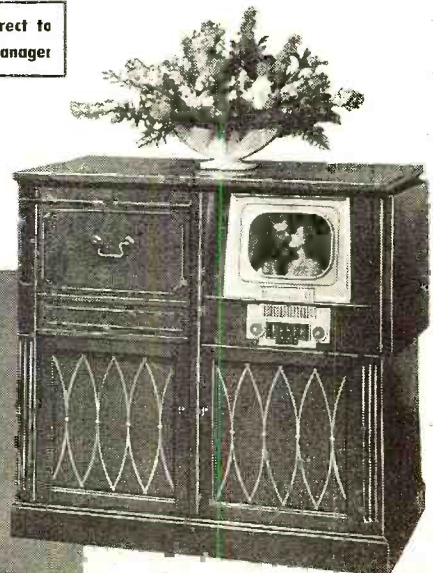

Products...Policies...Prices...Profits  
EVERYTHING'S BETTER ABOUT  
**Bendix Radio**

BENDIX RADIO BENDIX-RADIO DIVISION of BALTIMORE 4, MARYLAND

**Specify the**



**1201**

**DELUXE ALNICO 5  
LOUDSPEAKER**

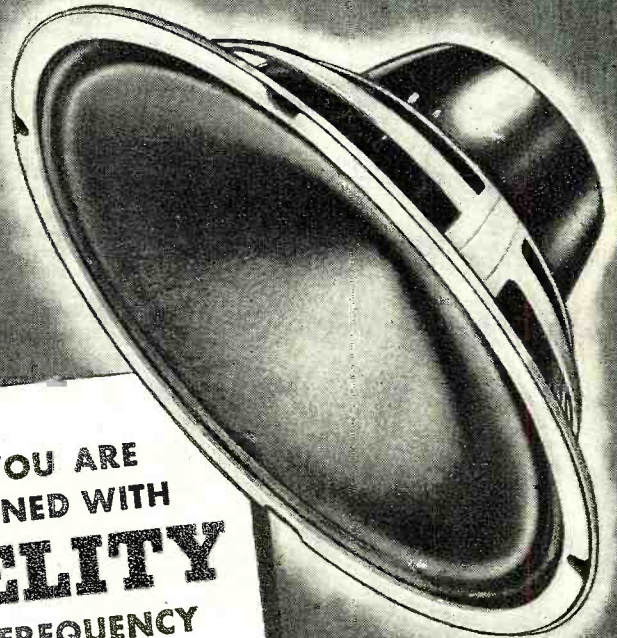

WHEN YOUR  
JOB DEMANDS  
**POWER**  
25 WATTS  
POWER HANDLING  
CAPACITY

WHEN YOU ARE  
CONCERNED WITH  
**FIDELITY**  
BROAD FREQUENCY  
CHARACTERISTIC  
50—13,000 CYCLES

EQUIPPED WITH  
THE FAMOUS  
**GENERAL ELECTRIC**  
ALUMINUM FOIL BASE  
VOICE COIL

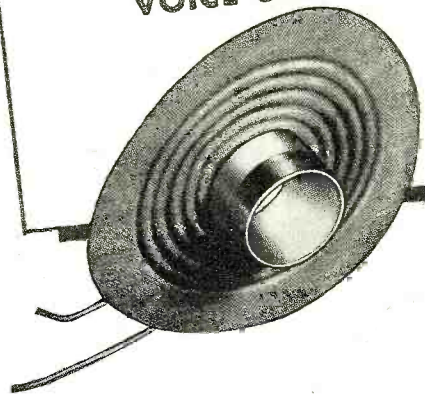

**P**OWER, fidelity and a price that will amaze you for a speaker of this exceptionally high quality—it's the G-E 1201.

It's a wide range speaker with the frequency response stretched out at both ends of the curve to give intense realism, smooth, full lows and "high fidelity." A curvilinear cone is employed to provide this extended frequency response. Alnico 5, 14½ ounces of it, gives high sensitivity and smooth response.

The moving parts in the speaker assembly are ruggedly designed to take high power without damage to the speaker in any way.

Note: Frequency response 50—13,000 cycles.

For complete information on this outstanding speaker write: *General Electric Company, Electronics Park, Syracuse, New York.*

**GENERAL**



**ELECTRIC**



# Learn RADIO

TELEVISION, ELECTRONICS  
*by*  
SHOP METHOD HOME TRAINING

Let NATIONAL SCHOOLS, of Los Angeles, a practical Technical Resident Trade School for almost 50 years, train you for today's unlimited opportunities in Radio

You receive all parts, including tubes, for building this fine, modern Superheterodyne Receiver. This and other valuable standard equipment becomes your property.

*these two FREE books will tell you how*



## Good Jobs Await the Trained Radio Technician

You are needed in the great, modern Radio, Television and Electronics industry! Trained Radio technicians are in constant and growing demand at excellent pay—in Broadcasting, Communications, Television, Radar, Research Laboratories, Home Radio Service, etc. National Schools Master Shop Method Home Study Course, with newly added lessons and equipment, can train you in your spare time, right in your own home, for these exciting opportunities. Our method has been proved by the remarkable success of National Schools-trained men all over the world.

## You Learn by Building Equipment with Standard Radio Parts We Send You

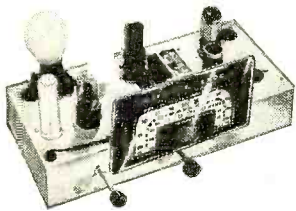

Your National Schools Course includes not only basic theory, but practical training as well—you learn by doing. We send you complete standard equipment of professional quality for building various experimental and test units. You advance step by step until you are able to build the modern superheterodyne receiver shown above, which is yours to keep and enjoy. You perform more than 100 experiments—build many types of circuits, signal generator, low power radio transmitter, audio oscillator, and other units. The Free Books shown above tell you more about it—send for them today!

## NOW! New Professional Multitester Included!

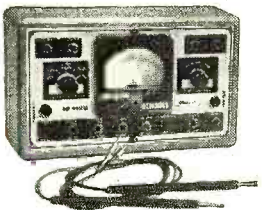

This versatile testing instrument is portable and complete with test leads and batteries. Simple to operate, accurate and dependable. You will be able to quickly locate trouble and adjust the most delicate circuits. You can use the Multitester at home or on service calls. It is designed to measure AC and DC volts, current, resistance and decibels. You will be proud to own and use this valuable professional instrument.

GET THE DETAILS—SEND THE COUPON →

Lessons  
and

Instruction

Material Are Up-to-date, Practical, Interesting.

National Schools Master Shop Method Home Training gives you basic and advanced instruction in all phases of Radio, Television and Electronics. Each lesson is made easy to understand by numerous illustrations and diagrams. All instruction material has been developed and tested in our own shops and laboratories, under the supervision of our own engineers and instructors. A free sample lesson is yours upon request—use the coupon below.

Here's Just a Few of the Interesting Facts you Learn with the

### FREE MANUAL

1. Routine for diagnosing Radio Troubles.
2. Preliminary inspection of Receivers.
3. How to Test and Measure Voltages.
4. How to Test Speaker in Audio Stages.
5. How to Trace the Circuit and Prepare Skeleton Diagram.
6. Complete Reference Table for Quickly Locating Receiver Troubles.

Both Home Study and Resident Training Offered

**APPROVED FOR  
VETERANS**

Check Coupon Below

**NATIONAL SCHOOLS**  
LOS ANGELES 37, CALIFORNIA EST. 1905



**MAIL OPPORTUNITY COUPON FOR QUICK ACTION**

National Schools, Dept. RN-9  
4000 S. Figueroa, Los Angeles 37, Calif.

Mail me FREE the books mentioned in your ad including a sample lesson of your course. I understand no salesman will call on me.

NAME.....AGE.....

ADDRESS.....

CITY.....ZONE.....STATE.....

Check here if Veteran of World War II

# ALPETH

## NEW WORD ON TELEPHONE CABLES

Lead makes an excellent sheath for telephone cables—sixty years and thousands of miles in service have well proven that. But lead is useful in other ways—storage batteries and paint, to name only two. So the telephone industry shares the limited available supply with other claimants.

Before the war when there was no lead shortage, Bell Laboratories engineers sought to develop better and cheaper cable sheaths. An ideal sheath is strong, flexible, moisture-proof, durable and must meet specific electrical requirements. No single material had all those virtues, so thoughts turned to a composite sheath, each element of which should make a specific contribution to the whole.

Various materials and combinations were studied. Desirable combinations that satisfactorily met the laboratory tests were made up in experimental lengths, and spent the war years hung on pole lines and buried in the ground. After the war, with an unparalleled demand for cable and with lead in short supply, selection was made of a strong composite sheath of ALuminum and PolyETHylene. Now Western Electric is meeting a part of the Bell System's needs with "alpeth" sheathed cable.

Meeting emergencies—whether they be storm, flood or shortage of materials—is a Bell System job in which the Laboratories are proud to take part.

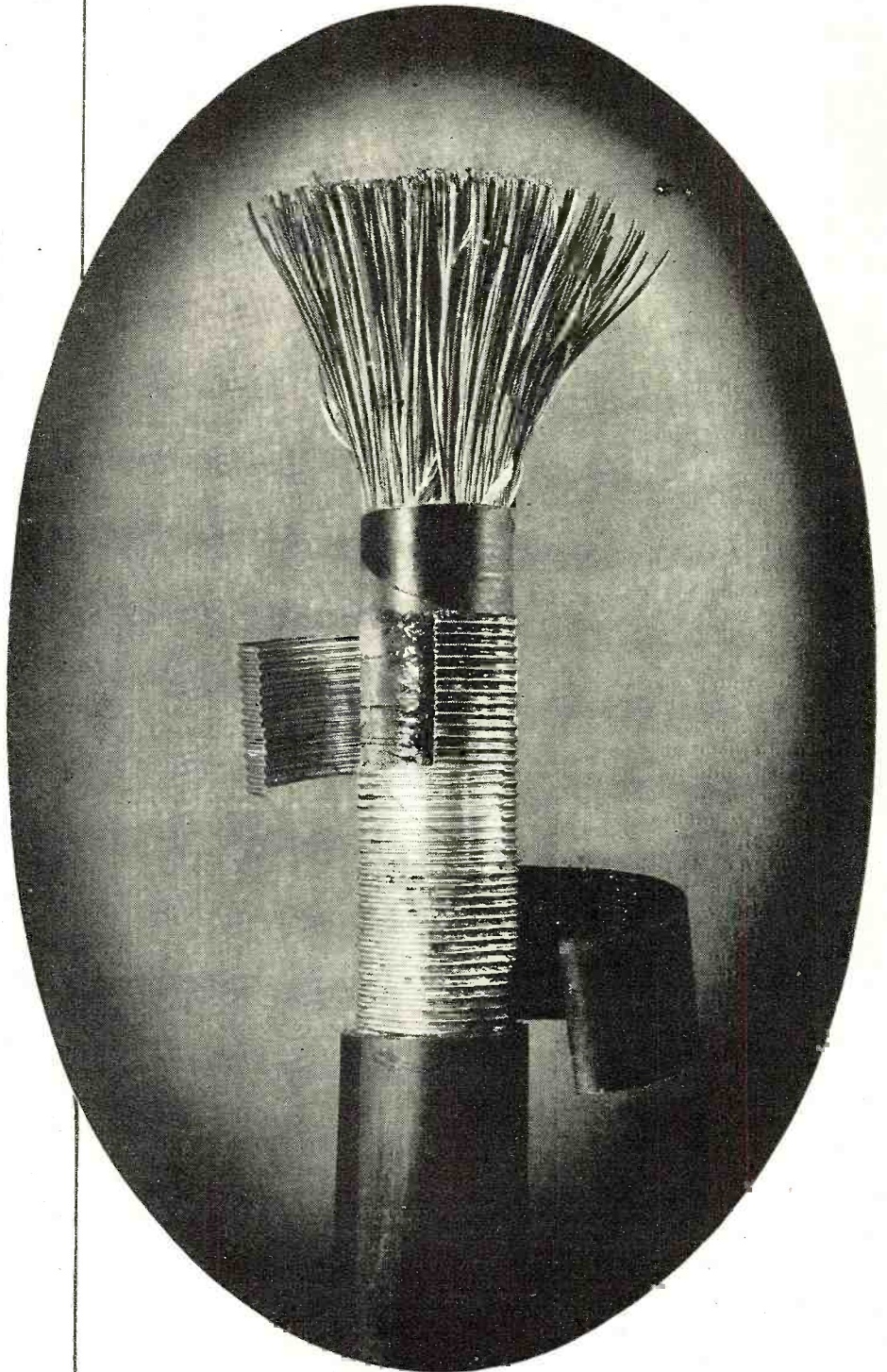

## BELL TELEPHONE LABORATORIES



• EXPLORING AND INVENTING, DEVISING AND PERFECTING FOR  
CONTINUED IMPROVEMENTS AND ECONOMIES IN TELEPHONE SERVICE.



# Only **AIR KING** Experience

could Build this Matchless

## WIRE RECORDER

PHONO-COMBINATION



**AIR KING Portable  
WIRE RECORDER  
Model A-750-1**

**\$139<sup>50</sup>**

*Includes federal excise tax  
Slightly higher in Zone 2*

### **AIR KING has the "know-how"!**

BUILDERS OF FINE RADIOS for 28 years, AIR KING likewise pioneered the Wire Recorder. From the time of its drawing-board inception, AIR KING engineers laboriously strived for that perfect, popular-priced Wire Recorder . . . the recorder that guarantees vivid reproduction . . . and versatility to meet all uses. As a result of these years of concentrated effort toward perfection and the thousands upon thousands of AIR KING Wire Recorders still giving matchless service, the AIR KING is your best Wire Recorder buy.

### **AIR KING has the experience!**

AIR KING PRODUCTS CO., INC., 172 53rd ST., BROOKLYN 32, N. Y. • Export Address: Air King International, 75 West St., New York 6, N. Y.

### Compare these exclusive **AIR KING features —**

- RECORDS DIRECT FROM RADIO
- RECORD PLAYER. Plays 10" & 12" records
- RECORDS DIRECT FROM PHONOGRAPH
- 5-TUBE AMPLIFIER (including rectifier)
- Automatic shut-off at end of play or rewind of wire
- Crystal mike for hand, table or stand
- Rewind speed: 6 times forward speed
- Erases automatically when recording over used wire
- Safety lock prevents accidental erasure
- Covered in leatherette. Luggage-type carrying case
- Weighs 30 lbs. • 5" Alnico V P.M. speaker
- Complete with these extras: Two spools of 15-minute wire and cable for radio attachment

# AIR KING RADIO

Division of HYTRON RADIO & ELECTRONICS CORP.

*The Royalty of Radio Since 1920*



# HARVEY HAS THE TOPS

**FM TRANSLATOR**  
General Electric Model XFM-1

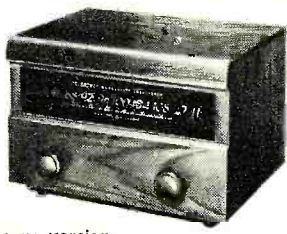

Post-war version of the old G.E. J.F.M-90 Translator which was used and enjoyed by tens of thousands of discriminating radio listeners.

Covers 88-108 mc range, dial 12 inches long, uses guillotine tuning for highest efficiency, high stability. Designed for export, has power inputs for 110 to 250 volts, 50/60 cy. Used in conjunction with good audio section or separate amplifier will provide best FM listening you ever heard. In attractive natural walnut cabinet — 10¾" high x 15¾" wide x 11¾" deep, complete with 8 tubes. Tropic-proof construction. Quantity limited, no more available. Get your order in while they last!

Available only from HARVEY  
Special price .....\$49.50

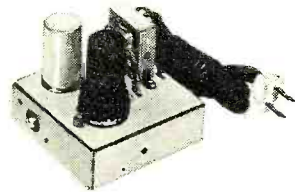

## GE PRE-AMPLIFIER

Just arrived in stock, the new GE Phonograph Pre-Amplifier with built-in power supply for use on 105-125 V. AC only. Does not use AC-DC type power circuit, has self-contained power transformer and is completely isolated from power line. For use with GE Variable Reluctance Cartridge.

Net.....\$9.57

## LS-3 SPEAKER



Signal Corps model, 6" PM speaker, weather resistant, in rugged crackle finish steel case. Complete with self-contained transformer to match 4000-ohm load. Voice coil impedance 6-8 ohms. Ideal for many uses around the shack, drive-in theatres, etc.

Harvey Special .....\$4.95

All prices Net, F.O.B., N.Y.C.  
Subject to Change Without Notice

Telephone: 7-1900 LO. 3-1800

**HARVEY RADIO COMPANY INC.**  
103 West 43rd St., New York 18, N. Y.

# Within the INDUSTRY

**GENERAL ELECTRIC COMPANY** has announced the formation of a new Television Division within the company's research laboratory.

Clifford G. Fick, until recently division engineer of the Receiver Division, has been chosen to head the new division. Mr. Fick has been with *General Electric* since August of 1925 and has served in both the transmitter and receiver divisions of the company.

\* \* \*

**W. W. WAGNER** has been appointed assistant sales manager of the *Sparton Radio & Appliance Division* of *Sparks-Withington Company* of Jackson, Michigan.

In his new position, Mr. Wagner will work with Henry L. Pierce, the recently appointed sales manager of the Division. Mr. Wagner served as district merchandising manager for *Sparton* in the Northern Illinois territory since March and prior to that time was engaged in various phases of radio and appliance merchandising for over twenty years.



\* \* \*

**WILLIAM BALDERSTON**, executive vice-president of *Philco Corporation*, was named president of the company, succeeding John Ballantyne who was elected chairman of the board.

The position of chairman of the board was vacated by Larry E. Gubb who declined re-election because of illness. Mr. Gubb will continue to serve as a member of the company's board of directors, the executive committee, and the finance committee.

The new president of the corporation joined *Philco* in 1930 when he organized the Car Manufacturers' Division of the company to handle sales of automobile radios to the motor car industry. Mr. Balderston was named vice-president in charge of operations in 1944 and since May, 1946 has been executive vice-president of the company.

\* \* \*

**NOBLITT-SPARKS INDUSTRIES**, manufacturers of *Arvin* radios, is now occupying a new 22,400 square foot glass and steel building in Columbus, Indiana.

Nine parallel assembly lines, where components enter at one end and emerge 160 feet later as finished radio sets, are now working full time turning out nine *Arvin* models.

With all radio manufacturing facili-

ties now transferred to the new location, the company will soon begin converting its old radio assembly space into new and enlarged administrative and executive quarters.

The new factory is a one-story building with a flat roof and the entire skeleton is of welded steel construction.

\* \* \*

**PRESTO RECORDING CORPORATION** has moved from New York City into their recently completed plant in Paramus, New Jersey.

The new plant houses the factory, laboratories, and general offices of the company. More than 80,000 square feet on a single floor has been allocated for the exclusive use of laboratories and shops. Additional space is provided for basement storage and air-conditioned general offices.

The company's new address is P.O. Box 500, Hackensack, New Jersey.

\* \* \*

**JOHN F. RIDER PUBLISHER, INC.** has announced the opening of a Chicago office with Joseph K. Rose in charge.

Mr. Rose has been associated with the radio industry for years, having served as service manager for *Wells Gardner and Company* for approximately 13 years.

With the opening of the Chicago office, the *Rider* organization will be in a better position to serve the radio manufacturing industry, schools, and jobbers located in that area. With the expansion of the *Rider* publications to embrace the home receiver field including FM, television, and public-address systems it became imperative to have someone on the spot in the hub of the radio manufacturing industry.

Mr. Rose may be reached at 6240 North Francisco Avenue, Chicago 45, Illinois.

\* \* \*

**PAUL L. CHAMBERLAIN** has been appointed manager of sales for *General Electric Company's* Transmitter Division succeeding Philip G. Caldwell who left the company July 1st to accept a position with the *American Broadcasting Company*.



Mr. Chamberlain has been manager of sales in the company's Receiver Division since 1945 and has been associated with the radio industry since 1925. His post in the Receiver Division has been assumed by Walter M.

**RADIO & TELEVISION NEWS**

# AS NEW AS THE FUTURE!

... the only transformer  
line of its kind

*Advanced, practical  
engineering  
gives you*

## THESE OUTSTANDING FEATURES

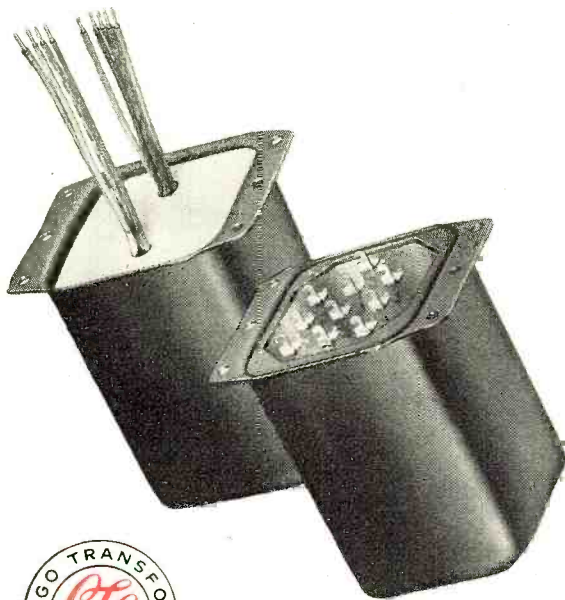

# CHICAGO TRANSFORMERS

*Sealed in Steel*

*Have Complete Details On Hand For Your New Equipment Planning*

**WRITE TODAY FOR CATALOG**

**CHICAGO TRANSFORMER** Division, Essex Wire Corporation

3501 ADDISON STREET, CHICAGO 18, ILLINOIS

### 1 SEALED IN STEEL CONSTRUCTION

Chicago Transformer's drawn steel cases provide convenient, compact mountings; seamless steel-wall protection against atmospheric moisture and corrosion; unsurpassed strength and rigidity to withstand shock and vibration; clean, streamlined appearance that adds eye-appeal to any equipment.

### 2 CHOICE OF CONNECTORS

Solder lugs or wire leads. Most units are available with identical ratings in two base styles to fit your price and/or wiring preference.

### 3 CHARACTERISTICS KEYED TO MODERN TUBES

Voltage, current, and output ratings have been designed for one purpose only—to fill the requirements of the receiving, transmitting, and industrial electronic tubes currently most in demand. No listings wasted on obsolete circuit needs. Result—a condensed, yet comprehensive, line that's right in step with today's new circuit designs.

### 4 EXACT MATCHING OF REACTORS

with power transformers. Current ratings of plate and filament supply transformers and of the high voltage plate transformers are matched by choke capacities specially designed for the purpose. Mountings match, as well, for uniform, "tailored" good looks.

### 5 TRUE HIGH FIDELITY THROUGHOUT 3 RANGES

Frequency response within  $\pm 1/2$  db; distortion exceedingly low, even at low frequencies. These are the characteristics of the input and output transformers. Driver and modulation transformers provide response within  $\pm 1$  db. All audio units are designed for frequency ranges that fit three classes of up-to-date audio application. Full Frequency Range: 30-15,000 cycles (good up to 20,000 cycles, where required). Public Address Range: 50-10,000 cycles. Communications Range (voice): 200-3,500 cycles.

**For the Finest  
Phonograph Performance Ever Achieved . . .**

*Newcomb*

**ANNOUNCES 2 GREAT NEW  
PHONOGRAPH AMPLIFIERS**

with the **MAGIC RED KNOB**

**L**OGICAL culmination of years of electronic research and engineering development continuously carried on in Newcomb laboratories, these new phonograph amplifiers, used in conjunction with suitable accessories, will produce unbelievable realism from recorded music or from AM-FM radio tuners connected to them. Their improved response at low volume, their beautifully clear, undistorted treble tones and the exclusive new "Magic Red Knob" control, which virtually eliminates surface noise and distortion from records in any condition, make these two amplifiers the best possible choice for those custom phonograph installations.

**MODEL KXLP-30:** Its ample power permits use of the famous Newcomb KX-Series dual tone control circuit, which provides tonal range and balance unattainable in less costly circuits. This circuit allows controlled emphasis of the desirable but power-consuming fundamental bass tones, avoiding emphasis of harmonic bass, so unacceptable to discriminating listeners.



**MODEL HLP-14:** Brings to music lovers an entirely new listening pleasure in a somewhat less expensive unit than the superb KXLP-30. Exceptional tonal balance at whisper volumes is a feature of the HLP-14. Its adaptability to use with the new AM-FM tuners, wide range loudspeakers and new phonograph pickups make it an ideal starting point for those increasingly popular custom installations.



Both include inputs for G.E. type pickups.

*Newcomb*  
**AUDIO PRODUCTS CO.**  
Dept. F, 6824 Lexington Avenue • Hollywood 38, California

Send for Specifications

**HOW TO GET THE MOST**  
from only  
**BASIC TEST EQUIPMENT**  
Servicing by Signal Substitution

The Simple, Modern, Dynamic Speed approach to receiver alignment and adjustment problems, FM-AM-TV.

- Nothing complex to learn
- No extra equipment to purchase
- Universal — non-obsolescent
- Employs only Basic Test Equipment

**S-S-S tells HOW — In simple, direct language.**

New 9th edition now off the press. 100 pages of valuable information.

Available from all leading radio parts and equipment distributors or directly from factory at only 40c per copy.

PRECISION APPARATUS COMPANY, Inc. • 92-27 Horace Harding Blvd., Elmhurst 9, N. Y.

Skillman who formerly served as sales manager of the company's standard line radios.

\* \* \*

**HOWARD W. SAMS & CO., INC.** is currently sponsoring the national lecture tour of A. C. W. Saunders of *Saunders Radio & Electronics School* of Newton, Massachusetts.

Mr. Saunders, whose television training program is the basis for the *Howard W. Sams' "Photofact"* course in television principles, recently addressed groups of service technicians in Bethlehem, Philadelphia and New York City on the fundamentals of television receiver servicing.

His lecture schedule will take Mr. Saunders to every major section of the country during the balance of this year.

\* \* \*

**NATIONAL COMPANY, INC.** of Malden, Massachusetts has announced the appointment of two new sales representatives to handle the company's line of radio products.

*Northwestern Agencies, Inc.*, 4130 First Avenue, South, Seattle, Washington, will cover Oregon, Washington, Idaho, and Montana on behalf of *National* while the Indiana and Michigan territories will be served by *Neal Bear Corporation* of Peninsula, Ohio.

\* \* \*

**PAUL THOMPSON** has been named chief electronic engineer of the *Turner Company*, Cedar Rapids, Iowa.



Mr. Thompson, a graduate of the University of Minnesota, comes to the *Turner Company* with a wide range of experience in electroacoustic engineering. As head of the engineering staff, Mr. Thompson will devote his time to research and product development of the company's line of microphones and electronic equipment.

\* \* \*

**D. W. HAVEN** is the new comptroller of *Lear, Incorporated*, filling the post which has been vacant for some time.

Mr. Haven comes to *Lear* from *Solar Aircraft Company's* Des Moines plant where he served as assistant treasurer. In his new position, he will assume the financial responsibilities covering the various *Lear* plants at Grand Rapids, Elyria, and Piqua, Ohio, in addition to the wholly-owned subsidiary, *Lear, Incorporated of California*.

\* \* \*

**FABIAN LEWIS** has been named manager of telephone and telegraph sales for *Raytheon Manufacturing Company* of Waltham, Massachusetts.

This new position was created in order to facilitate the application and supply of *Raytheon* products to the telephone industry.

Mr. Lewis brings to this activity several years' experience in the operation of telephone properties, as an  
(Continued on page 146)

# "I like the **DEPENDABILITY** of **OHMITE** Products"

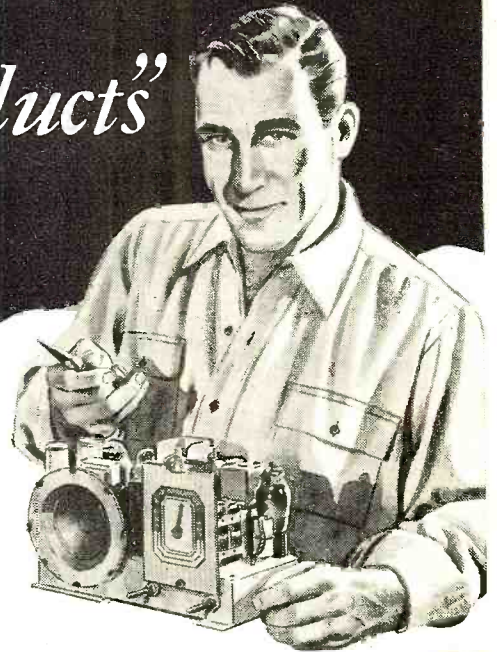

AMONG radio servicemen, amateurs, and industrial users everywhere—there's a definite preference for Ohmite resistance products. These men know—from experience—that Ohmite resistors and potentiometers provide long, trouble-free service.

Here's the reason why you get extra performance. Every Ohmite product is designed and constructed to stand up under severe operating conditions. Every unit is built to withstand the effects of shock, vibration, temperature extremes, altitude, and humidity. Make sure you get the benefit of this unfailing dependability. Ask for Ohmite products by name.

## LITTLE DEVIL COMPOSITION RESISTORS

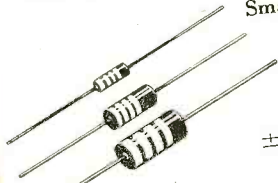

Small and sturdy, these units come in  $\frac{1}{2}$ , 1, and 2-watt sizes. 10 ohms to 22 megohms. Tol.  $\pm 10\%$  and  $\pm 5\%$ . Values to 2.7 ohms available in 1-watt size.  $\pm 10\%$  tolerance.

## DIVIDOHM ADJUSTABLE RESISTORS

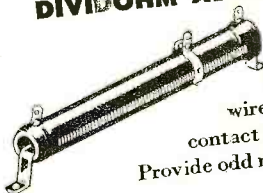

Used as multi-tap resistors or voltage dividers. Have a narrow strip of exposed wire along one side to provide a contact surface for the adjustable lugs. Provide odd resistance values quickly.

## BROWN DEVIL WIRE-WOUND RESISTORS

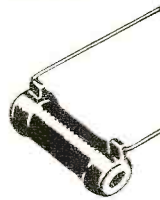

Rugged, dependable, vitreous-enamelled surface protects winding from mechanical damage. Brown Devils are easily mounted by tinned-wire leads. Tol.  $\pm 10\%$ . In 5, 10, and 20-watt sizes.

## TYPE AB POTENTIOMETER

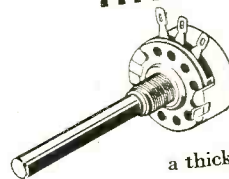

A 2-watt molded composition unit with good margin of safety. It is unaffected by heat, cold, moisture, or length of service. Resistance element is a thick, solid-molded ring.

Write for Catalog 19



OHMITE MANUFACTURING COMPANY • 4885 Flournoy St., Chicago 44, Ill.



# Be Right with **OHMITE**

RHEOSTATS • RESISTORS • TAP SWITCHES • CHOKES • ATTENUATORS

# GIANT FALL CLEARANCE

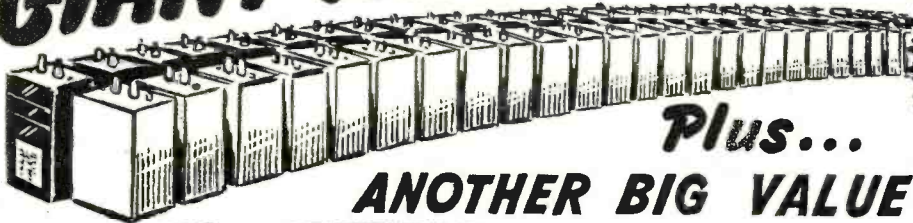

**FILTER  
CHOKES**

Plus...

## ANOTHER BIG VALUE EVENT!

**"SURPRISE"  
TRADE-IN ALLOWANCES ON YOUR  
USED TEST AND COMMUNICATION  
EQUIPMENT**

Month after month Walter Ashe keeps on offering top allowances on your used, factory-built Test Instruments and Communication Equipment. Renewed fall activity in the field of radio and electronics makes this the ideal time to replace worn, outmoded equipment. So join the parade. Cash in on generous, money-saving allowances that will amaze you! Make Walter Ashe prove to you that now, as always, your trade-in's worth more at the Walter Ashe Store!

No. 8056—8 HY x 500 MA.  
55 ohm DC. Res. Shpg.  
Wt. 28 lbs.

Only ..... \$11.85

No. 8783—2-6 HY x 500 MA  
Swinging Choke. Shpg. Wt.  
28 lbs.

Only ..... \$11.85

No. 6317—4 HY x 300 MA.  
40 ohms DC RES. Shpg.  
Wt. 13 lbs.

Only ..... \$4.95

No. 4205-E—2.5 HY x 280  
MA. 43 ohm DC Res. Shpg.  
Wt. 5 lbs.

Only ..... \$1.49

No. 10062—10 HY x 250  
MA. 110 ohms DC Res.  
Shpg. Wt. 18 lbs.

Only ..... \$3.49

No. 0122—10 HY x 250 MA.  
164 ohm DC Res. Shpg. Wt.  
13 lbs.

Only ..... \$3.95

No. 2785—Dual 12 HY x 250  
MA. 150 ohm DC Res. per  
section. Shpg. Wt. 17 lbs.

Only ..... \$4.95

No. 5269—4.5 HY x 150 MA.  
79 ohms DC Res. Shpg. Wt.  
6 lbs.

Lots of Two 79c ea.  
One only ..... 99c

### BIGGER-THAN-EVER BARGAINS

From "THE HOUSE OF  
"SURPRISE" TRADE-INS!"

**HAMS  
LOOK!**

Real GALLON  
Transformers

TYPE E-8707

3000 Volts D. C. out of  
filter at 650 MA. (ICAS).  
Pri: 115/230 VAC 60 Cy.

Shpg. Wt. 47 lbs.

ONLY \$48<sup>00</sup>

TYPE E-5706  
2500 Volts D. C. out of filter at 500 MA.  
(ICAS). Pri: 115/230 VAC 60 Cy.

Shpg. Wt. 38 lbs. ONLY \$33<sup>00</sup>

TYPE E-5105  
2000-1750-1500 Volts D.C. out of filter @  
500 MA. (ICAS) Pri: 115/230 VAC 60 Cy.  
Shpg. Wt. 30 lbs.

ONLY \$30<sup>00</sup>



## ATTENTION

Radio Servicemen  
and Dealers!

Now! Walter Ashe  
offers sensational sav-  
ings in used, recondi-  
tioned, "good-as-  
new" Test Instru-  
ments and Communi-  
cation Equipment.

Write for complete  
list of these bar-  
gains. Use the  
handy coupon be-  
low.



**BOMBSHELL  
SPECIAL!**

Reversible Motor

Originally used for heat con-  
trol on Douglas Bombers.  
Ideally suited for rotation of  
lightweight Amateur, FM or TV beams. Gearing  
down to 1/2 to 2 RPM with max. torque rating of  
50 inch pounds. Size 2 3/4" x 3 3/4" x 8". Simple in-  
structions included. Shpg. Wt. 6 lbs.

LIMIT OF ONE  
TO A CUSTOMER.

ONLY \$7.45

Since 1922 one of America's leading  
distributors of Test and Communi-  
cation Equipment.

CONVENIENT TIME PAYMENT PLAN.

Use the Coupon to Prove That YOUR TRADE-IN'S WORTH  
MORE AT THE WALTER ASHE STORE

WALTER ASHE RADIO CO.  
W. H. DuBord, WOQDF, Mgr., Amateur Div.  
1125 Pine St., St. Louis 1, Missouri

RN-9

Gentlemen:

Rush bigger-than-ever "surprise" trade-in allowance on my  
\_\_\_\_\_ for  
(describe used equipment)

(show make, model of new equipment desired)  
 Send bargain list of reconditioned, good-as-new  
Test Instruments,  Communication Equipment.  
(check one or both)  
 Put my name on your "Priority" list to receive your Big,  
New 1949 Catalog.

NAME.....

ADDRESS.....

CITY.....ZONE.....STATE.....

NOW AVAILABLE!



PE-103 Plug

Plug to fit output socket  
of PE-103 Dynamotor.  
Shpg. Wt. 1/2 lb.

ONLY 95c

BC-654 Plug

Plug to fit input socket  
of BC-654 transmitter.  
Shpg. Wt. 1/2 lb.

ONLY 95c

Big, new 1949 Catalog  
now in production. Re-  
serve your FREE copy  
today!

PHONE  
Chestnut 1125

All the big name brands  
of new Test and Com-  
munication Equipment in  
stock . . . ready for  
immediate delivery the  
day you write, wire or  
phone!

All prices F.O.B. St. Louis

**Walter Ashe  
RADIO CO.**

THE HOUSE OF "SURPRISE" TRADE-INS  
1125 PINE ST. • ST. LOUIS 1, MO.

**Radio Servicemen: Here is the Industry's  
Newest, Practical Course in**

# Television & FM Servicing

**Backed by the Famed  
Facilities of CREI**  
★  
**Safeguard Your Future!**  
**Earn more Money  
in the Expanding  
Servicing Field**



● CREI—long known as one of the nation's outstanding technical schools—now offers good radio servicemen a practical home study course in Television and FM Servicing. It is based on the assumption that you are a practicing radio repairman with sense enough to know that if you don't learn FM and Television, you might as well close up in a year or two. The shop without qualified FM and TV repairmen will soon be as obsolete as a blacksmith shop . . . because approximately 800,000 television sets will be produced in 1948 alone . . . because there will be 4,000,000 *more* radios with FM by the end of this year . . . because the repair business will go to the men with ability to do a scientific servicing job on *any* kind of set.

CREI developed this course at the request of several nationally known manufacturers and distributors who recognized the lack of qualified servicemen to handle TV and FM installations and servicing. After careful preparation CREI has created this special servicing course. It has been tested—and *proved* in the field. It is as practical as we can make it. It enables you to put the knowledge you gain from each lesson to work immediately. It *won't* make you rich overnight. It *won't* make a television engineer out of you in "ten easy lessons". You *don't* get a "free television set with your first lesson"—or your last. *But here's what you do get:* a systematic method of FM and TV installation and maintenance,

knowledge of TV fundamentals, lessons in basic radio mathematics, meters, lenses and mirrors, inductive coupling and condensers at ultra-high frequencies, practical applications of resonant circuits, TV tubes, FM receiver alignment, TV antennas, picture synchronization, TV receivers, TV troubleshooting—and much more.

CREI is an accredited technical school with 21 years experience teaching radio engineers and technicians, both in home study and residence school work. Hundreds of practical engineers with key positions in industry, radio, and TV stations owe their successful training to CREI. More than two years of preparation have gone into this FM & TV servicing course. Backed by one of America's foremost technical institutes, it is designed for one purpose only: to help a good radioman become a good FM-TV serviceman. The course is *practical*; the cost is *popular*. Get complete details by filling in and mailing this coupon.

**Radio Service Division of**

## **CAPITOL RADIO ENGINEERING INSTITUTE**

*An Accredited Technical Institute*

**Dept. 498, 16th & Park Rd., N. W., Washington 10, D. C.**

*Branch Offices: New York (7) 170 Broadway • San Francisco (2) 760 Market St.*

**September, 1948**

**MAIL  
TODAY**

**CAPITOL RADIO ENGINEERING INSTITUTE**  
16th & Park Road, N. W., Dept. 498, Washington 10, D. C.

Gentlemen:

Please send me complete details of your new home study course in Television and FM Servicing. I am attaching a brief resume of my experience, education and present position.

NAME \_\_\_\_\_

STREET \_\_\_\_\_

CITY \_\_\_\_\_ ZONE \_\_\_\_\_ STATE \_\_\_\_\_

I AM ENTITLED TO TRAINING UNDER G. I. BILL.

# F. M. & TELEVISION

Use this new giant manual for trouble-shooting, repairing, and alignment of any 1947-1948 F.M. and Television set. Every popular make, including new F.M. tuners, AM-FM combinations, and all types of television receivers. Circuit diagrams, theory of operation, test hints alignment data, including both meter and oscilloscope methods. This is the material you need to learn how to fix any modern F.M. and Television set. Don't turn away this profitable work for lack of knowledge and information. Use this new **Supreme** manual to save time and money on your next F.M. or television job. Data on 192 large pages, 8½x11 inches. Sturdy, manual-style binding. Special price, **\$2.00** postpaid, only.....

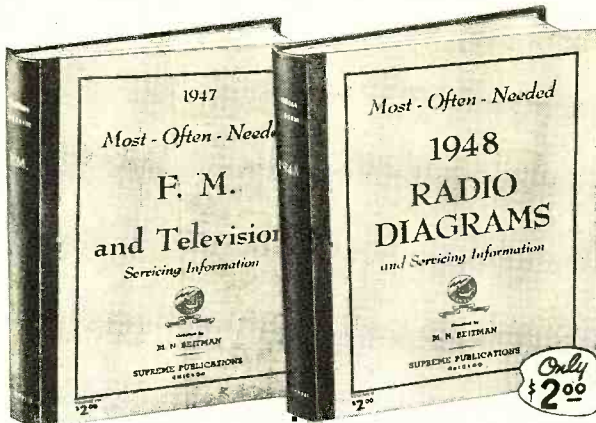

Make these two new mammoth volumes your money-saving source of data on all recently released receivers. Learn about modern circuits, be ready to repair any new radio no matter how complex. Your cost is only \$2 for each of these large manuals. With these two volumes on your work-bench, there is nothing else to buy, nothing else to pay — a whole year of radio diagrams and service data yours for a couple dollars total. Again **Supreme Publications** beats all competition and gives radio servicemen greatest bargains in service manuals.

# NEW 1948 DIAGRAMS

Be prepared to repair quickly all new 1948 sets. In this big single volume you have clear, large schematics, needed alignment data, parts lists, voltage values, and information on stage gain, location of trimmers, and dial stringing, for almost all recently released receivers. **Supreme** manuals make toughest jobs amazingly easy. Diagrams help you find faults in a jiffy. Speed-up all repairs. The time saved on your next job will pay the \$2 bargain price for the complete manual — after that you use it **FREE**. A worthy companion to the 7 previous volumes used by over 120,000 shrewd radio servicemen. Other volumes listed below. New 1948 manual covers models of 42 different manufacturers. Giant size: 8½x11", 192 pages + index. Manual-style binding. Price, only... **\$2.00**

**BOTH BOOKS FREE**

FREE to every customer of books listed on this page. Both books will be included **FREE** with every order for manuals selected from this page. "How to Use Diagrams" gives hints, suggestions, short cuts on the use of diagrams in radio servicing. The 26-page **INDEX** will tell you just what models are included in **SUPREME Most-Often-Needed Radio Diagrams** manuals. If you need a circuit at any time, the **INDEX** will tell you where to get it. Limited quantity. Write today.

**Most Popular Models Made by:**  
 R.C.A., Zenith, Philco, Sears, Fada, Emerson, Belmont, Detrola Radio, Majestic, United Motors, G.E., Westinghouse, Arvin, Stewart-Warner, Admiral, Delco, Stromberg-Carlson, Western Auto, Wards, Sparton, Motorola, Gamble, Crosley, and many others.



**SUPREME DIAGRAM MANUALS**

1947	1946	1942	1941	1940	1939	1926-38
MOST-OFTEN-NEEDED RADIO DIAGRAMS						DIAGRAMS
Each manual has between 192 and 208 pages of diagrams						240 Pages
and service hints; large size, 8½x11". Price, each.....						Price \$2.50

You can speed-up and simplify radio repairs with **Supreme Publications** manuals. Service all radios faster, better, easier, save time and money, use these **most-often-needed** diagram manuals to get ahead, earn more per hour. For the remarkable bargain price (only \$2 for most volumes) you are assured of having in your shop and on the job, needed diagrams and other essential repair data on 4 out of 5 sets you will ever service. Every popular radio of all makes, from old-timers to new 1948 sets, including F.M. and Television, is covered. Clearly printed circuits, parts lists, alignment data, and helpful service hints are the facts you need to be an expert in radio servicing. Save hours each day, every day, begin to earn more by making repairs in minutes instead of hours. Let these manuals give you diagrams for 80% of all sets. There is no need to spend large sums for bulky, space-wasting manuals of other publishers, or to buy additional drawings every few weeks; be wise, use **SUPREME** Manuals to get the most in diagrams and service data for the smallest cost. Select manuals wanted and rush "no-risk" coupon.

**SIMPLIFIED RADIO SERVICING**

New, revolutionary different **comparison** technique permits you to do expert work on all radio sets. Most repairs can be made without test equipment or with only a volt-ohmmeter. Many simple, point-to-point, cross reference circuit suggestions locate faults instantly. Covers every radio set—new and old models. Over 1,000 service hints, 63 job-sheets, 26 large trouble-shooting blueprints. 114 tests you can make using a 5c resistor. Complete **\$1.50**

**Record Changers Manuals — \$1.50 each**

**Post-War Models**  
 Service expertly all modern (1945-1948) record changers. All popular makes. Just follow simplified factory instructions to make needed adjustments and repairs. Hundreds of photographs and exploded views. Large size: 8½ x 11 inches. 144 fact-filled pages. Price only \$1.50 postpaid.

**Pre-War Models**  
 Just what you need to repair quickly thousands of pre-war (before 1942) automatic record changers, manual units, pickups, wireless oscillators, recorders, and combinations. Hundreds of mechanical and electrical diagrams. 128 large pages; giant size: 8½ x 11 inches. Price, only \$1.50.

**See Your Radio Jobber or Send Coupon →**

**Supreme Publications**  
 PUBLISHERS OF RADIO BOOKS, MANUALS, AND DIAGRAMS

**NO RISK TRIAL ORDER COUPON**

**SUPREME PUBLICATIONS, 9 S. Kedzie Ave., Chicago 12, ILL.**

Ship manuals checked on 10-day trial under your guarantee of satisfaction or money back. I am to receive to keep **FREE**. Complete **INDEX** and "How to Use Diagrams."

<input type="checkbox"/> New F.M. and Television Manual.....	\$2.00	<input type="checkbox"/> 1948	<b>PRICED AT ONLY \$2 EACH</b>
<input type="checkbox"/> Simplified Radio Servicing.....	1.50	<input type="checkbox"/> 1947	
<input type="checkbox"/> Post-War Record Changers.....	1.50	<input type="checkbox"/> 1946	
<input type="checkbox"/> Pre-War Record Players & Recorders 1.50		<input type="checkbox"/> 1942	
<input type="checkbox"/> I am enclosing \$..... send postpaid.		<input type="checkbox"/> 1941	
<input type="checkbox"/> Send C.O.D. I am enclosing \$..... deposit.		<input type="checkbox"/> 1940	
		<input type="checkbox"/> 1939	

1926-1938—\$2.50

Name: \_\_\_\_\_  
 Address: \_\_\_\_\_



8224

8223

8212

8205

8209

8204

8216

8225

8235

# TRANSMISSION LINE CABLES

*Every Type for Every Service*

Sold Exclusively Through Recognized Wholesale Distributors

8210

8226

8227

8229

8228

**Belden**  
*Radio WIRE*

Six Months  
from Today

# Which will YOU hold?

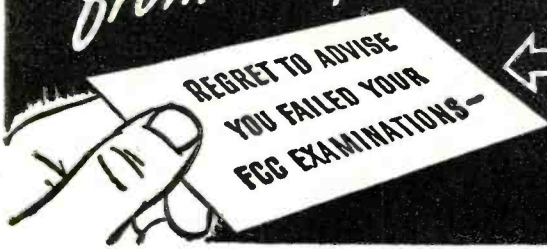

THIS  
OR THIS



## WANT YOUR FCC COMMERCIAL LICENSE IN A HURRY?

Use CIRE Training and Coaching Service—and Get Your "Ticket" in a Few Short Weeks!

Thousands of new jobs are opening up—FM, Television, Mobile Communication Systems. These are only a few of the radio fields which require licensed radio technicians and operators.

Get your license without delay. Let Cleveland Institute prepare you to pass FCC license examinations, and hold the jobs which a license entitles you to, with CIRE streamlined, post-war methods of coaching and training.

Your FCC Ticket Is Recognized in All Radio Fields as Proof of Your Technical Ability

More than ever before an FCC Commercial Operator License is a sure passport to many of the better paying jobs in this New World of Electronics.

Employers frequently give preference to the license holder, even though a license is not required for the job. Hold an FCC "ticket" and the job is yours!

### Hundreds of Satisfied, Successful Students

"I have taken the first class phone license examination and received my first class ticket last Saturday, May 31. In closing I must say yours is an excellent radio course, and I really appreciate your help and the fine service you have rendered me."

Student #2876N12

"I passed the FCC examination in radiotelephone 2nd class, at Detroit on June 3rd, and I want to thank you for your ready assistance as my instructor on Section I of Nilson's Master Course."

Student #2799N12

"I have had my 1st class radiotelephone license since March of this year, and plan to continue with your course since I find it a great help in studying transmitters."

Student #2779N12

"After sending in Lesson E-9 I took the commercial operator's license examination for 2nd class radiotelephone, and passed O.K. I received the license last week."

Student #2772N1

**FREE BOOKLET**—Tells you the Government requirements for all classes of FCC commercial licenses. (Does not cover Amateur License examinations.) Use coupon below for Booklet B.

## OTHER

Cleveland Institute Home Study Courses Offer Complete Technical Radio Training from Low-Level to College-Level, for the Radioman with Practical Experience!

### COURSE A—Master Course in Radio Communication

A complete course covering the technical fundamentals of radio-electronics, for the radioman who wants a general review. Includes preparation for Broadcast station employment.

### COURSE B—Advanced Course in Radio Communication Engineering

A genuine college-level radio engineering course, completely mathematical in treatment. For the advanced radioman with considerable practical experience and training.

### COURSE C—Specialized Television Engineering

An advanced college-level course for the radioman who has had formal training equivalent to A and B.

These three courses in radio-electronics offer a complete, thorough technical training for radioman who wants to cover the field. Available separately or combined.

**FREE CATALOG**—Describes all Cleveland Institute home study courses—tells of CIRE unique, post-war methods of training. Use coupon below for Catalog A.

How To Pass  
FCC  
LICENSE  
EXAMINATIONS

CLEVELAND INSTITUTE  
OF  
RADIO ELECTRONICS  
Terminal Tower Cleveland, Ohio

Don't Delay—  
Write Today!

Approved for  
Training  
Under "G-I  
Bill of Rights"

## HOW TO PASS Commercial FCC LICENSE EXAMINATIONS...

CLEVELAND INSTITUTE OF RADIO ELECTRONICS  
Contractors to the Canadian Broadcasting Corporation

RN-9 TERMINAL TOWER

CLEVELAND 13, OHIO

Cleveland Institute of Radio Electronics RN-9 Terminal Tower, Cleveland 13, Ohio		<input type="checkbox"/> Veterans check for enrollment information under G-I Bill. NO OBLIGATION—NO SALESMEN.
Gentlemen:	<input type="checkbox"/> Please send me your Booklet B, "HOW TO PASS THE FCC COMMERCIAL LICENSE EXAMINATIONS," and information about your home study course for preparation for FCC License Examinations. (Does not cover Amateur License Examinations.)	
	<input type="checkbox"/> Please send me your Catalog A, describing all of your home study radio-electronics courses.	
	<input type="checkbox"/> I desire training in course <input type="checkbox"/> A <input type="checkbox"/> B <input type="checkbox"/> C.	
NAME _____		
ADDRESS _____		
CITY _____	ZONE _____	STATE _____

RADIO & TELEVISION NEWS

SEPTEMBER, 1948

**RADIO**  
TELEVISION  
**NEWS**

**RADIO-ELECTRONIC**

# Engineering

TELEVISION

RADAR

ELECTRONICS

RESEARCH

COMMUNICATION

MAINTENANCE

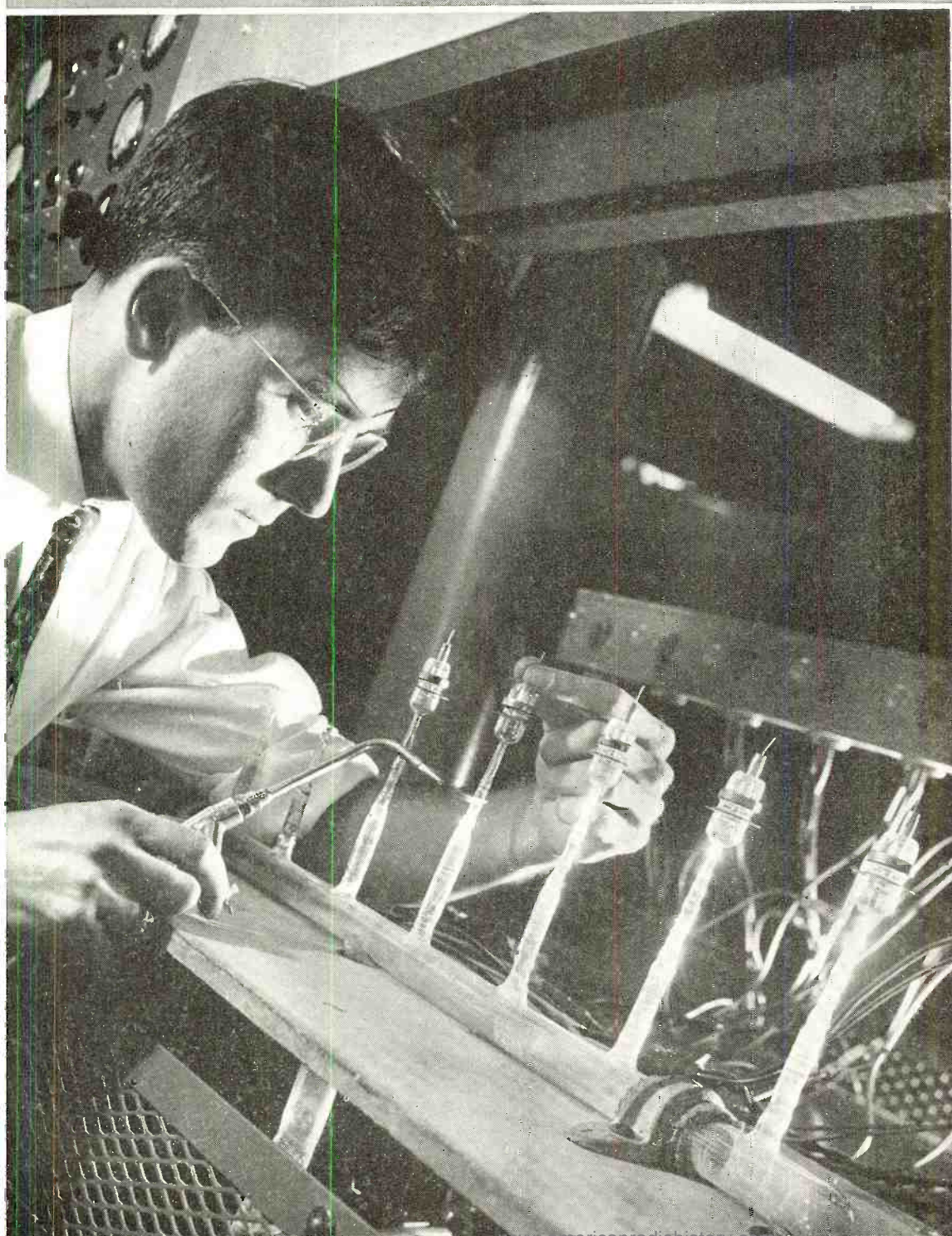

# RADIO-ELECTRONIC

## Engineering

Trade Mark Registered U.S. Patent Office No. 422017

ELECTRONICS • COMMUNICATIONS • TELEVISION • RESEARCH • MAINTENANCE

## SEPTEMBER, 1948

ELECTRONIC DIGITAL COMPUTERS.....	David Fidelman	3
CAPACITY TRANSDUCER.....	Alvin B. Kaufman	6
FREQUENCY STABILIZATION OF OSCILLATORS.....	R. A. Whiteman	8
A SINGLE-STROKE OSCILLOSCOPE SWEEP.....	Albert H. Taylor	12
PULSE COMMUNICATION SYSTEMS.....		
.....	Sidney Moskowitz and Joseph Racker	14
CAPACITY TUNED TELEVISION TUNER.....	J. A. Stewart	24

### DEPARTMENTS

NEW PRODUCTS .....	22	INDUSTRIAL REVIEW .....	29
NEWS BRIEFS .....	26	PERSONALS .....	30
TECHNICAL BOOKS .....	31		



RADIO-ELECTRONIC ENGINEERING is published each month as a special edition in a limited number of copies of RADIO & TELEVISION NEWS, by the Ziff-Davis Publishing Company, 185 N. Wabash Avenue, Chicago 1, Illinois.

VOLUME 11, NUMBER 3, Copyright, 1948, Ziff-Davis Publishing Company

COVER PHOTO — By Sylvania Electric Products, Inc.

Five planar triodes are exhausted and sealed at one time on trolley exhaust equipment in the production design section of the Advanced Development Laboratory, Sylvania Electric Products, Inc., Kew Gardens, N.Y. Used as a pulse generator, finished tubes will develop peak outputs of 200 watts.



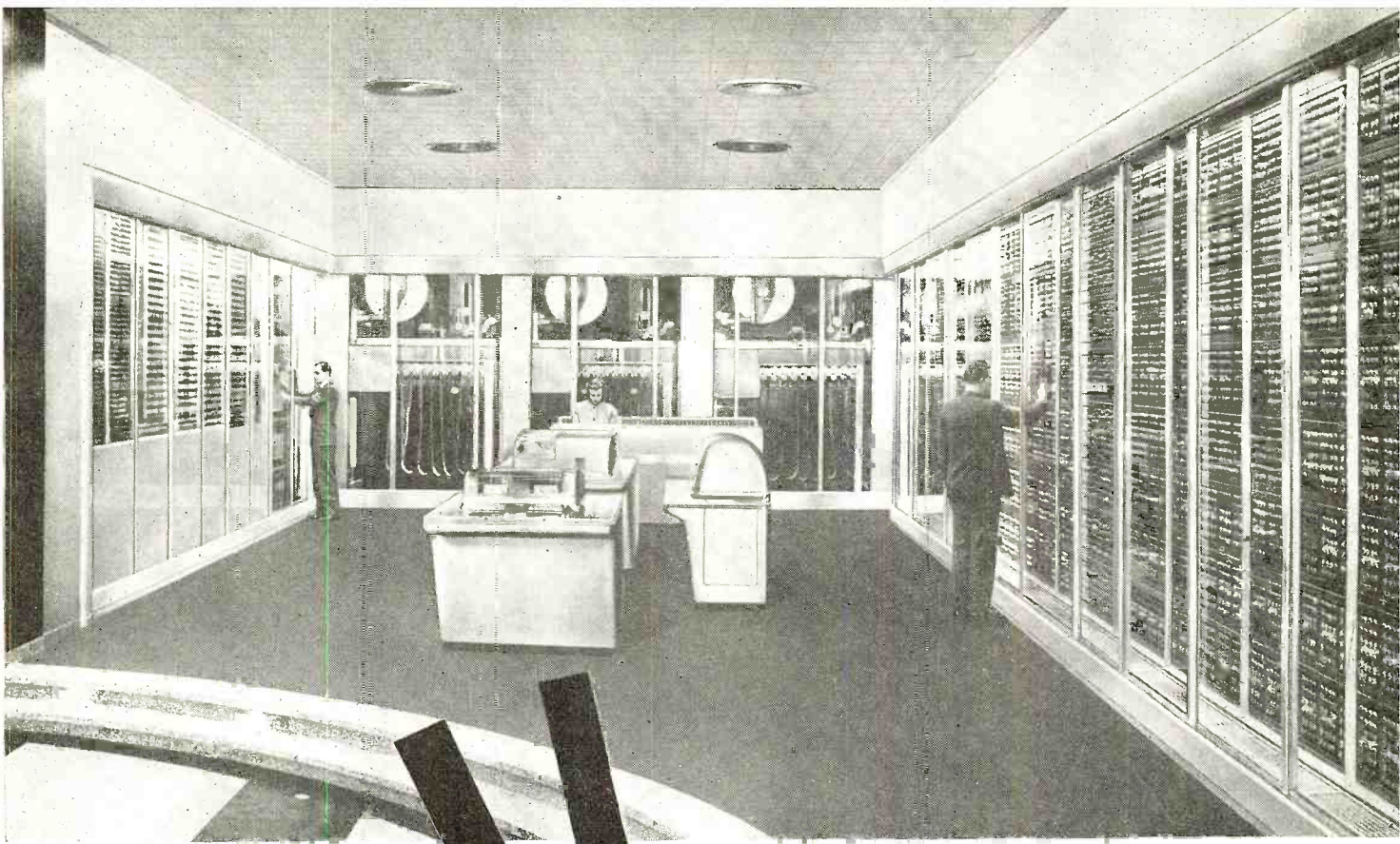

Photograph of the complete IBM selective sequence electronic calculator.

By

**DAVID FIDELMAN**

IN RECENT years the application of electronic principles and methods has solved many problems which would otherwise have been almost impossible of solution. It is quite likely that of all these applications the most important to the future advancement of basic science and technology as a whole is the application of electronics to the field of mathematical calculation and computation.

In the past, the application of mathematics to scientific and engineering problems has always required the use of many simplifying assumptions since the problems encountered in practice are generally too complex to permit an exact solution without an almost impossible amount of tedious computation. There do exist methods by which it is possible to find numerical solutions to the equations of many physical problems, but the application of such methods requires such lengthy and involved computation as to be almost hopeless. Therefore, the necessary procedure in solving such problems has been to make assumptions which simplify the mathematics sufficiently so that they may be solved by mathematical methods whose solutions are already known. Since errors are introduced by the initial assumptions, an attempt is made to com-

pensate for them in the final result.

These methods of simplifying the physical problem for the sake of mathematical simplicity are adequate when applied to simple physical systems, but they are found to be completely inadequate when attempts are made to apply them to some of the more complex systems. For this reason it has not been possible to solve many of the more complex physical and engineering problems satisfactorily.

The development and application of electronic calculating machines have completely changed this state of affairs. Modern types of electronic calculators are capable of solving in a single day problems which otherwise would take foremost mathematicians and physicists years to solve. Electronic calculators are capable of performing mathematical

operations extremely rapidly, and can be designed to perform such operations automatically according to instructions with which they have been furnished. Thus it is possible to set up a set of equations representing extremely complex physical systems without the necessity of making many simplifying assumptions, and have the equations solved by a calculating machine. Since the calculator operates rapidly and automatically, the tediousness and time of solution are so greatly reduced that it has now become practical to solve such complex equations.

A few typical examples of complex physical systems which have been solved or are expected to be solved by the use of electronic computers are:

(a) Trajectories of projectiles, which depend upon the type of projec-

# ELECTRONIC DIGITAL COMPUTERS

*Part I of a 3-part article outlining electronic principles and techniques used in electronic digital computers.*

$$\begin{array}{r}
3(10^2) + 6(10) + 2 \\
+ 4(10^2) + 8(10) + 5 \\
= 7(10^2) + 14(10) + 7 \\
= [7(10^2) + 1(10^2)] + 4(10) + 7 \\
= 8(10^2) + 4(10) + 7 \\
\hline
362 \\
485 \\
\hline
847
\end{array}$$

Table I. Mechanism for performing the function of addition.

tile, its velocity, angle of fire, and the resistance of the air as a function of velocity (which is itself a complex empirical function having no simple mathematical formulation)

- (b) Systems of simultaneous linear equations which occur in petroleum chemistry, electrical circuit analysis, aircraft and structural design, and in statistics
- (c) Hydrodynamic equations of fluid flow
- (d) Accurate weather forecasting from the great amount of meteorological data which can be accumulated
- (e) Such problems as the accounting and calculating needs of large businesses and government agencies and a large variety of other applications to complex problems.

In addition to these applications in solving the difficult mathematical equations of science, engineering and applied mathematics, the various types of electronic calculators have still other applications in many other fields of technology and industry. The most outstanding example is in the field of automatic control. Here the electronic circuits may be used to control a process or function according to any pre-assigned functional relationship between a large number of different dependent and independent variables. By use of

Table II. Mechanism for performing the function of multiplication.

$$\begin{array}{r}
485 \\
\times [1(10^2) + 3(10) + 2] \\
= 485 \\
485 \\
4850 \\
4850 \\
4850 \\
\hline
48500 \\
= 64020
\end{array}
\qquad
\begin{array}{r}
485 \\
132 \\
\hline
970 \\
1455 \\
485 \\
\hline
64020
\end{array}$$

such calculating circuits in automatic control applications, a wide variety of intricate and complex operations can be performed automatically to an extremely high degree of accuracy. In many cases such forms of automatic control by means of electronic calculating devices are decidedly superior to the use of human controls.

### Electronic Principles in Computer Design

Various types of automatic calculating machines have been known for a very long time, but it has only been since the introduction of electronic principles that they have been able to become more than aids to the performance of arithmetical problems. Previous to this, mathematical machines were mainly devices making use of mechanical methods to perform certain operations. Such devices have reached a fairly high stage of development. For example, electrical calculators are available which will automatically perform addition, subtraction, multiplication and division operations on numbers having as many as ten or more digits. It is also possible to integrate curves and to find the solutions of certain types of differential equations by means of mechanical calculating devices.

However, by the introduction of electronic circuits, it has also become possible to initiate and control very long and complicated sequences of operations in which succeeding operations may depend upon the results of previous operations which may require judgment on the part of the machine, and to perform such calculations extremely rapidly.

These great advances in automatic calculators are due to certain very basic properties of the vacuum tube.

- (a) The electronic tube can operate at speeds far in excess of the capabilities of any mechanical devices.
- (b) Tubes provide useful power gain with negligible loading of the input circuit. Thus, greater accuracy can be attained since calculating circuits need be designed only to perform the calculating function, and need not deliver any power. If any appreciable power is needed to drive the output, this power may be generated in the plate circuit of an amplifier tube whose grid is excited by the calculating circuit.
- (c) Circuits using electronic tubes may readily be designed to offer a wide variety of desired types of response, from definite on-off trigger actions to fixed constant-gain amplifiers which are almost entirely independent of tube characteristics. In addition,

tubes have the feature of acting as a more or less unidirectional element, which simplifies interaction problems in the design of complete systems.

Tubes also have certain disadvantages which must be compensated for if they are to be used in precision circuits such as calculating circuits. For example, the characteristics can not be used directly in any type of precision circuit.

However, in electronic calculating circuits these disadvantages are reduced to negligible proportions in such a manner that full use may be made of the advantages of the electronic tube. This has been accomplished by using the tube as a simple on-off switch in digital computers, or as a null device in servo systems, or as an amplifier using negative feedback in such a manner that the amplification depends upon the circuit elements and not upon the tube characteristics. The use of the electronic tube in this manner, to take maximum advantage of the most desirable characteristics, has been primarily responsible for the great advances in calculating machine design and their greatly increased possibilities.

### Types of Computers

Calculating machines fall into two general types: digital computers and analogue computers. The analogue type of computer consists of an apparatus in which chosen physical quantities (such as length, electrical voltage, rotation, etc.) may be set up to vary in a manner mathematically analogous to the variation of the numbers in the problem under consideration. The slide rule is perhaps the most familiar example of an analogue computer. The digital type of computer, on the other hand, works out problems by methods which are basically the same as those which would be used in working out the same problem arithmetically on paper. Examples of digital computers are the use of the 10 fingers for counting, the Oriental abacus or counting-frame, and the ordinary desk adding or calculating machine.

Both types of calculating devices have their relative advantages and disadvantages, and the choice of which type is to be used in any individual case depends primarily upon the characteristics of the particular problem under consideration. As anyone is aware who has ever used a slide rule, the accuracy of analogue computers is limited by the accuracy with which one can set the input quantities or read the output, and the more complex the problem the more serious this difficulty becomes. In digital computers, since the elements have only positional significance as in the case of beads on a counting-frame,

there is no fundamental limit to the accuracy obtainable. However, digital methods require apparatus which is much larger, heavier and more complicated, and are therefore not always more desirable to use than analogue methods.

In the design and construction of the latest and most highly developed electronic calculators extreme accuracy is a far more important consideration than size and simplicity of construction; therefore these machines generally make use of digital computation methods. There are, however, many fields of application where small size and simplicity of construction are more important factors than extreme accuracy, and analogue computers are preferable for such types of applications. This article is concerned primarily with the theory and design of digital types of computers.

### Principles of Digital Computation

Since some problems might require an almost infinite amount of calculation for their solution, the advanced branches of mathematics such as algebra, calculus, group theory, etc., have been invented as a means of decreasing the amount of calculation required for the solution of problems. However, with the development of the latest electronic digital calculators, it has now become possible to apply the basic mathematical processes to the solutions of advanced problems without the necessity of using the short cuts and simplifications of higher mathematics. The average motor-driven electrical desk calculator can multiply two ten-digit numbers in approximately 10 seconds. The electronic calculator can perform the same operation in less than  $10^{-4}$  second. Thus a problem which would take a highly skilled mathematician or physicist from 10 to 20 years to solve by using the most advanced methods of modern mathematics might be solved arithmetically by the electronic digital calculator in a few hours.

The basic principle upon which all types of digital calculators operate is that of *counting*. By counting in a definite manner, and by properly sequencing various counting operations, it is possible to perform mathematical operations such as addition, subtraction, multiplication and division. It need hardly be noted that this procedure is not only the basis of electronic digital computers, but also of the ordinary method of performing arithmetical operations manually with paper and pencil or by counting on one's fingers. From this consideration it is obvious that the major requirement for the design of an electronic digital computer is that there must exist an electronic method of counting, and some means of automat-

ically sequencing the counting operations. Such circuits are well known, and they form the basis for the design of electronic digital calculators.

The addition of numbers is the most direct application of counting. For example, if one wants to add 3 to 4, one first counts to 4 and then counts an additional 3 numbers to 7, which is equal to the sum  $4 + 3$ . This same procedure is followed in adding any two numbers. In adding very large numbers the process of counting directly tends to become quite lengthy, therefore the decimal system has been introduced to save time in calculation. Thus instead of counting 362 numbers from 485 to find the sum of these two numbers, the operation would be performed as shown in Table I.

The actual operations which are performed in this addition are shown on the left, while the usual abbreviated form of this calculation is shown at the bottom. By use of the decimal system, the actual number of countings in this addition has been reduced from 362 to 18. However, the basic operation in this addition is still that of counting.

Multiplication also is readily performed by the counting process, since it can be considered as a series of successive additions. For example, multiplying  $a$  by  $b$  consists of finding the sum of  $a$  added  $b$  times. In multiplication, as in addition, the use of the decimal number system results in a considerable saving in the amount of calculation required. Thus, Table II shows how the number 485 is multiplied by 132.

The basic operation is again one of counting by means of successive additions as shown on the left, and usually performed in the more rapid abbreviated manner shown at the bottom.

The operations of subtraction and division are essentially addition and multiplication in a reverse direction. Subtraction is merely counting backwards from a given number, while division consists of finding the number of times one number can be successively subtracted from another number.

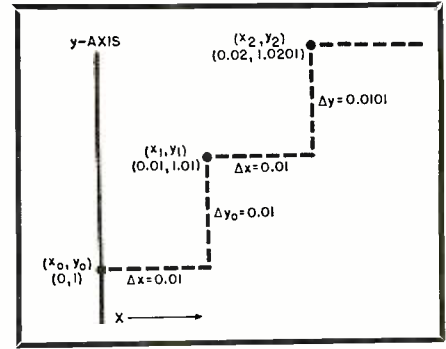

Fig. 1. Steps in the numerical solution of the differential equation  $dy/dx = y$ .

These four operations form the basis for all other mathematical processes. The manner in which square roots, cube roots, powers of numbers, etc., are obtained by making use of the above four operations will readily be recalled by anyone who has been exposed to the various arithmetic and algebra courses taught in school. These operations are further extended to the determination of logarithms, exponentials, trigonometric functions, and other functions of numbers, in a manner which is again familiar to present and former students of elementary mathematics. Generally these last-named functions are computed once, then compiled into a table of values for future reference to avoid the necessity of repeating the same calculations.

Differentiation and integration also are derived fundamentally from the four basic operations, since they are defined as the limiting cases of sums and differences in the following manner:

Differentiation:

$$\frac{dy}{dx} = \lim_{\Delta x \rightarrow 0} \frac{y(x + \Delta x) - y(x)}{\Delta x} \quad (1)$$

Integration:

$$\int y dx = \lim_{\Delta x \rightarrow 0} \sum_{i=1}^n y(x_i) \Delta x \quad (2)$$

As a simple example of the application of digital computation methods to the solution of differential equations,

(Continued on page 21)

Fig. 2. Two trigger circuits of the type which may be used in electronic counting applications.

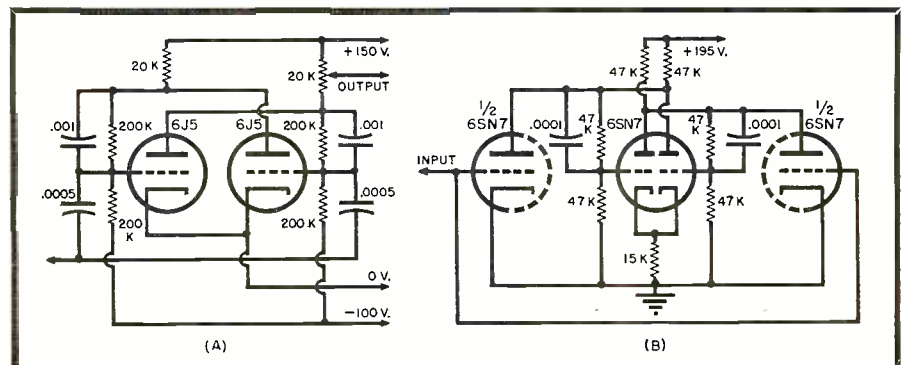

# CAPACITY TRANSDUCER

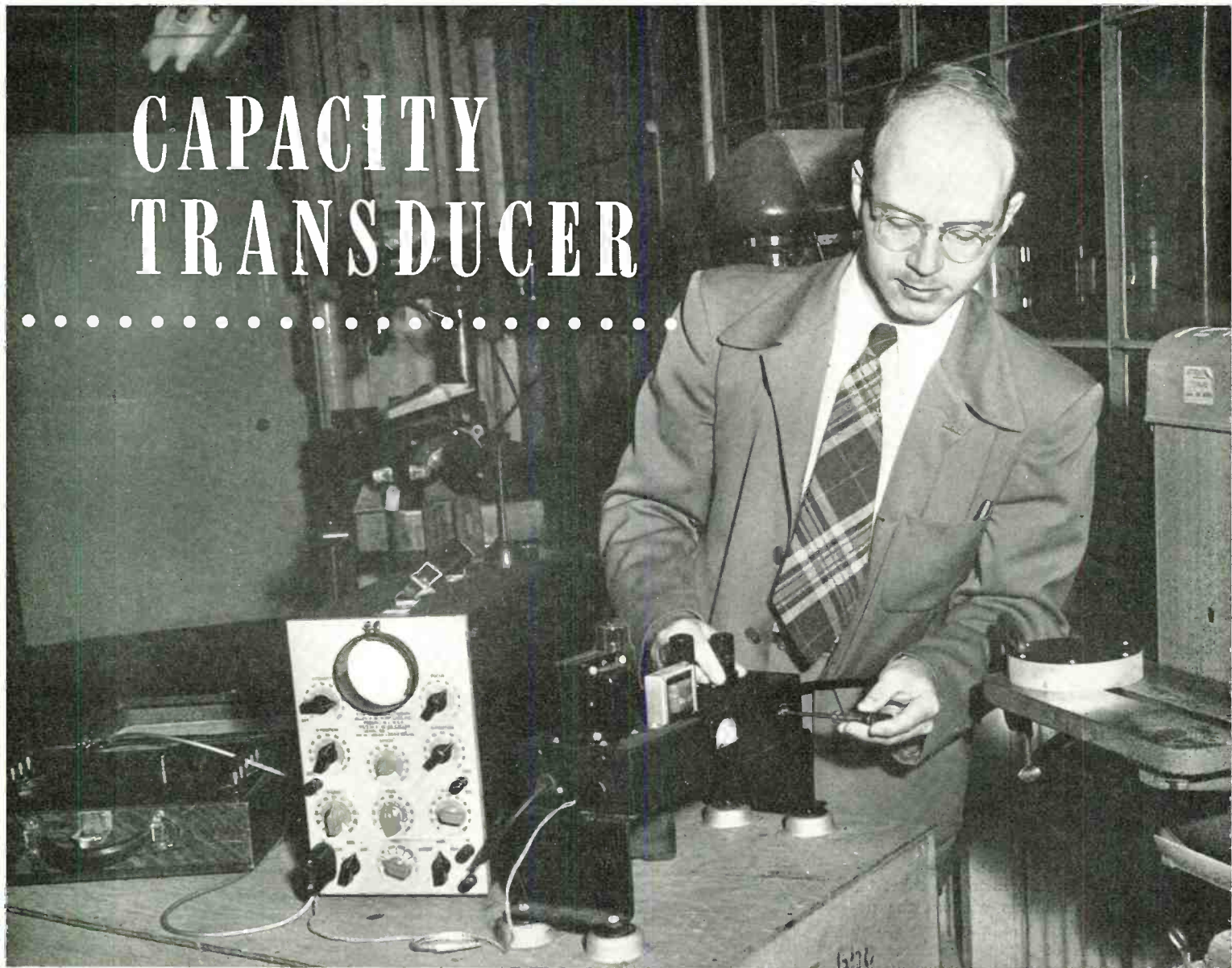

By **ALVIN B. KAUFMAN**

Douglas Aircraft Company, Inc.

***This device utilizes small variations in capacity to determine rotational and vibrational speeds.***

RECENTLY developed capacity transducer, which will change minute variations of capacity into electrical variations, has filled an important niche because it provides a simple unit with extreme sensitivity and few of the defects in standard bridges.

This high sensitivity capacity transducer makes available a revolution counter for machinery which *does not attach* to the rotating shaft, or load this rotating shaft in any way. The units pictured in this article are being used at Douglas Aircraft Company, Inc. for determining the r.p.m. of the engine-driven cabin supercharger. The impeller used in this supercharger can operate at over 30,000 r.p.m. These same units can be adapted for use with tur-

bines or any rotatory blade machinery without altering or adding anything to the machine for indicating r.p.m. or r.p.s.

At the present time, this device is used mainly for r.p.m. indication, but many applications are possible. One of these variations is vibration analysis wherein a capacity vibration pickup instead of a vane pickup is employed.

Three units are required in order to indicate r.p.m. or vibration. These are the pickup, a capacity transducer and an electronic frequency meter. The pickup for r.p.m. indication consists of one or more insulated vanes, located adjacent to the rotating shaft or attached blades in order to vary its vane capacity to ground with rotation of the shaft. This change of capacity is supplied to

The author adjusting the transducer. The vibration pickup may be seen clamped to a sanding machine.

the "capacity-transducer," which in turn supplies an alternating voltage whose frequency is proportional to shaft r.p.m. This alternating voltage is supplied to an electronic frequency meter whose scale may be read in terms of r.p.m. For permanent installations, it is preferable to redraw the frequency meter scale directly into r.p.m. so that no chart or calculations are required.

The above gives, in general, the outline of the engineering basis upon which the equipment was designed by the author. However, it is brief and does not answer numerous questions. A more detailed explanation will give the engineering information needed to design a similar system for other uses.

As the pickup unit works on a capacity principle, it is necessary to use a connecting cable whose capacity is low and yet very constant with movement or vibration. A suitable cable was RG 8/U coaxial cable with suitable coax plugs and receptacles. The pickup must fasten securely to the unit under test to minimize capacity variation with vibra-



tion. Total capacity of the connecting cable between the pickup and the transducer unit must not be excessively high or the variation in pickup capacity may fall to such a low percentage value of the total input capacity to the transducer unit that it will seriously hamper its alternating voltage output. Where a long cable is required the use of RG 7/U is recommended. The variation of pickup capacity should be at least five to ten per-cent of the total input capacity, but operation on lower percentages is possible under low vibration conditions. The illustration shows that a one-vane pickup was used on the supercharger until discontinued for a four-vane pickup. It should be noted that the number of pickup elements *does not* change the output frequency, but rather the number of vanes or blades on the rotating shaft. This is because *all four* (in this case) pickup elements come under and out of the blades at the same time, and thus are the electrical equivalent of one vane or element. Why then the increase of pickup elements? Increased capacity change and henceforth greater output is not the reason. Under extremes of high vibration or weaving of the rotating blades, a high degree of hash may be produced, which will prevent operation of the system. These stray variations in capacity may be corrected with the use of a three to four element pickup which will automatically balance out the weaving capacity changes. As one blade weaves closer to a vane, its increase in capacity is balanced by the other blade (180 degrees away) moving away from a vane or pickup element. With the four element pickup, good waveform was delivered to the *H-P* electronic frequency meter at over 30,000 r.p.m.

There are several other factors that must be considered in the design of the capacity pickup as used for r.p.m. indication. In theory it is nothing but an insulated metal plate, but what about spacing, vane area and air flow restrictions? The size and shape of the vane or pickup plate is not critical, but is chosen so that the impeller blade is not under the plate for more than 50% of its travel before the next blade passes

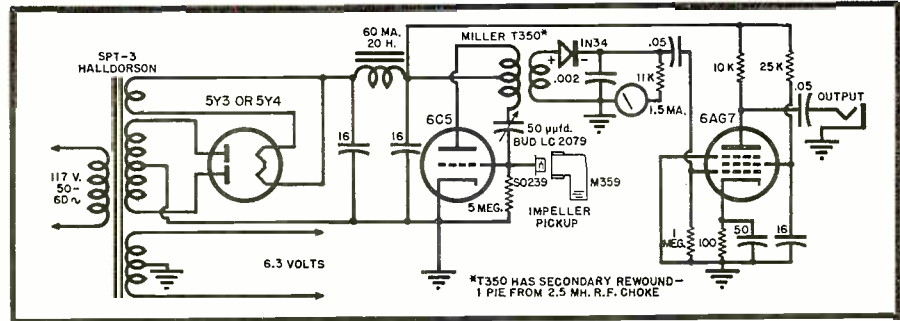

Fig. 1. Circuit of the DC-9 supercharger impeller r.p.m. capacity transducer. This unit was also used for vibration experimentation.

under the plate. This gives roughly a 1 to 1 low to high capacity cycle. This, through the transducer, delivers an alternating output wave. The electronic tachometers used with this unit require an "on to off" or vice versa alternation of input voltage preferably 1 to 1 but not to exceed 4 to 1 for a highly accurate indication. The spacing of the plate or pickup vane to the element depends upon input cable capacity, spacing between impeller blades and transducer sensitivity. Using a two foot RG 8/U cable with the four-vane pickup illustrated, spacings up to one quarter inch have been employed. This may best be determined by test, but in any case, no close tolerances or distances are necessary in spacing the element from the rotating blade. Air flow restriction may be limited to a low value by proper design of the pickup. This again hinges upon use of the pickup in different fields.

The capacity transducer unit changes the variation in pickup capacity into a useful audio frequency voltage suitable for application to an electronic frequency meter or tachometer. This unit consists of the familiar "capacity relay" or radio frequency oscillator, a detector and a one-tube amplifier. The capacity relay is an r.f. oscillator adjusted to oscillate feebly. The pickup unit is connected so that every time the capacity of the pickup increases it shunts the oscillator feed-back circuit more, and thus causes the oscillator to drop its r.f. output voltage. This r.f. carrier is rectified into d.c. and the a.c. component (caused by variations in the r.f. signal due to changing pickup plate

capacity) is amplified. This amplifier signal is then fed into an electronic frequency meter. The output of the capacity transducer must be over two volts, but not over two hundred to operate the *Hewlett-Packard* instruments in use at *Douglas*. As the output voltage is not critical and does not affect the r.p.m. indication, the capacity transducer units require no gain stabilization. Where this unit is used for vibration analysis, no gain stabilization is required where vibration frequency component indications only are required. However, where displacement in thousandths of an inch is a required indication, then full stabilization is required. This may be secured by power supply regulation and if necessary, crystal control of the oscillator frequency.

The sensitivity of this transducer unit may be realized when, with just its single amplifier tube, outputs of three r.m.s. volts are available for one or two micromicrofarad capacity changes.

The oscillation frequency of the transducer unit is not critical and for this reason the oscillator coil in the transducer unit is not tuned. As the whole unit is contained in a sealed metal box there is little likelihood of the unit radiating sufficient r.f. energy to warrant any FCC action. Where the particular coil specified in the drawings is not available, the oscillator should preferably be set to oscillate between 500 to 2000 kilocycles. This, in part, depends upon the capacity change available in any particular application. As may be noted on the diagram, the pickup ca-

(Continued on page 30)

Bottom view of the unit, showing the relatively few components required.

Top view of the unit with dust cover removed, showing placement of major components.

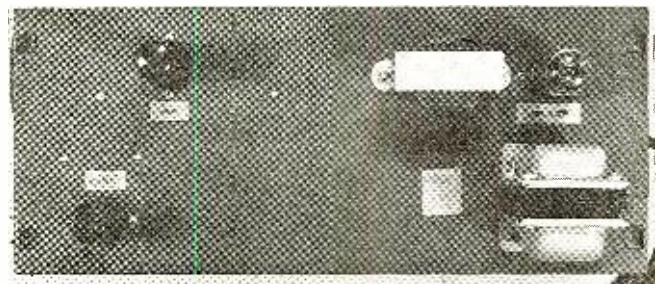
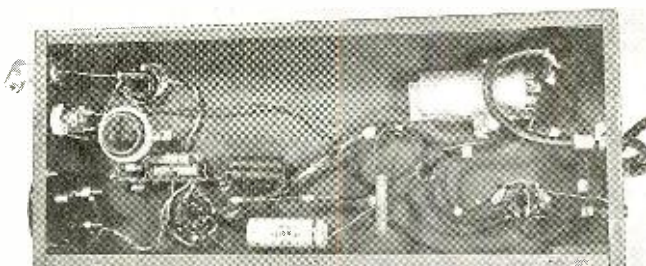

# FREQUENCY STABILIZATION of OSCILLATORS

By R. A. WHITEMAN, Consulting Engineer

*An analysis of special methods of frequency stabilization of self-excited oscillators.*

The choice of a particular type circuit for a high-frequency oscillator depends primarily upon the ultimate use of the circuit and not because one oscillator circuit is fundamentally better than another. All feedback-oscillator circuits can be derived from a single basic circuit and, as will be shown, are stable oscillators within known finite limits of certain parameters. At these limits, all feedback oscillators become unstable. To accomplish this analysis, consider the operation of the oscillator as an amplifier with the output connected to the input through a four terminal network. The performance of the oscillator will then be considered as an amplifier with a complex load impedance and a complex feedback circuit. This combination is said to be stable when an impressed small disturbance results in a response which goes on indefinitely, with the magnitude of the response limited only by the non-linearity characteristics of the amplifier. Under these conditions, the steady state voltage gain of the round trip around the circuit is unity. This relation is more clearly expressed with the aid of Fig. 2 where the amplification is represented by  $A$  and the feedback coefficient by  $B$ . The steady-state condition requires that  $A \cdot B$  must equal unity. It is quite possible that this product may be greater than unity before the steady-state condition is attained; however, the attainment of unity is accomplished during the initial transient period. Using a modified form of the Nyquist diagram this latter fact is illustrated in Fig. 3. In order to apply this diagram to the feedback oscillator, it is necessary to realize certain assumptions are required. They include the direct effect of non-linearity of the amplifier upon the suppression of the effective amplification factor of the tube. That is, it is permissible to define a new amplification factor which will be less than that used for amplifier design and will be determined quantitatively by the product of  $A \cdot B$  equal to unity. This, of course, assumes that the non-linearity of the amplifier does not appreciably affect the harmonic distortion, the interelectrode capacity or the frequency of oscillation. If the method used by Dr. H. Barkhausen in his, "Lehrbuch der Elektronen-Rohen 3 Band: Ruckkopplung" is modified to include plate current angle of flow as a parameter, the value of  $A$  becomes:

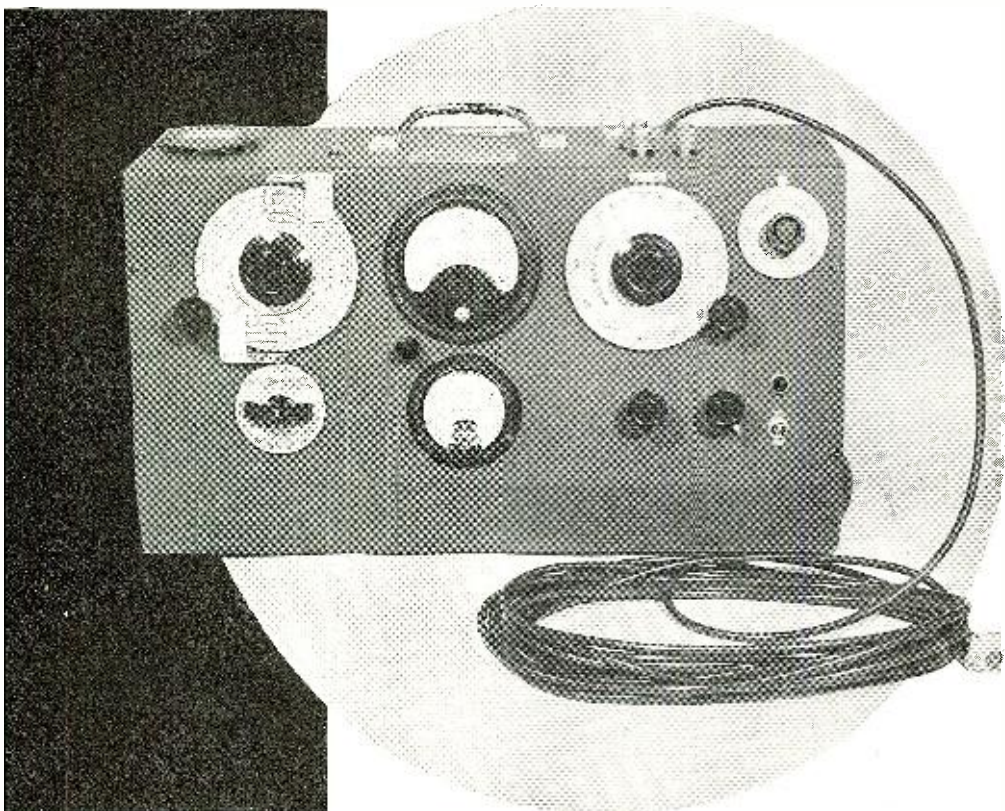

Fig. 1. Application of Q-meter to the determination of coax properties.

THE MANY causes of frequency variation in uncontrolled oscillators have been discussed and analyzed in a previous issue of this magazine. Of these causes, the most serious was the thermally-produced frequency changes in the tuned inductance and capacitance circuit of the oscillator. If compensation of the inductance variation by means of the capacitance change is not adequate for the stability requirements of the oscillator frequency, then a special means of stabilization is necessary.

It is the purpose of this article to analyze special methods of frequency stabilization and present experimental data to illustrate the value of these methods. It must be emphasized that the analysis presented in almost all of the following cases is approximate and therefore the conclusions indicate

a trend in the functional relations and not an absolute numerical answer to the problem. The indicated trend has directed the empirical work, thereby saving time in obtaining the desired results. This illustration of combining analytical and experimental work may well be studied by engineers who condemn mathematics for not yielding the final answer immediately. This method will be applied to both negative resistance and feedback type oscillators.

Fig. 2. Block diagram of a feedback oscillator.

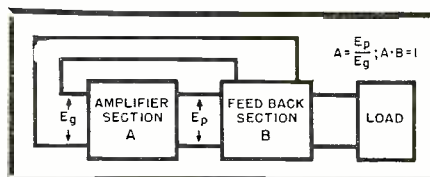

$$A = -\frac{\mu' Z_a}{\beta r_p + Z_a} \dots (1)$$

where  $\mu'$  is the modified  $\mu$  in accordance with the new definitions and  $\beta$  is  $\pi/(\theta - \sin \theta \cos \theta)$ .

Using the fact that:

$$A \cdot B = 1 \dots (2)$$

an algebraic operation yields:

$$B = -\left(\frac{1}{\mu'} + \frac{\beta r_p}{\mu' Z_a}\right) \dots (3)$$

for the purpose of drawing the vector diagram of  $B$ . To draw this diagram, it is necessary to select the load impedance as inductive or capacitive. If it is inductive, the vector representing  $Z_a$  will be in the first quadrant and if it is capacitive the vector will be in the fourth quadrant. This should be remembered since the vector diagram in Fig. 4 only considers  $Z_a$  to be inductive. To construct the vector  $-B$  the vector  $1/\mu'$  is drawn along the abscissa to the right and at the termination of  $1/\mu'$  the vector  $\beta r_p/\mu' Z_a$  is added, thereby giving  $-B$  as the vector sum of the quantities within the parenthesis in Eq. (3). The final result may be summarized by the expression:

$$-B = B \varepsilon^{-j \varphi} \dots (4)$$

It is important to note that Eq. (4) would become:

$$-B = B \varepsilon^{j \varphi} \dots (5)$$

for a load impedance  $Z_a$  which is capacitive instead of inductive. In other words, the vector  $-B$  must lie in either the first or fourth quadrant with the angle  $\varphi$  less than  $+90^\circ$  and more than  $-90^\circ$ .

To apply the foregoing information to the general feedback oscillator, refer to the block diagram shown in Fig. 5, with  $Z_1$  and  $Z_2$  forming the feedback network and  $Z_3$  providing the tank circuit. The mutual impedances are included in this diagram for the sake of generality and may or may not exist in any particular circuit application.

In addition to the above analysis, another condition for the maintenance of oscillations by a thermionic circuit of assumed linear characteristics can be represented algebraically in the form:

$$R + j \left( \omega L - \frac{1}{\omega C} \right) - (a + jb) = 0 \dots (6)$$

where the quantities  $a$  and  $b$  are the in-phase and reactive components of the effective series circuit impedance. The two conditions which must be satisfied in accordance with Eq. (6) are:

$$R = a \dots (7)$$

$$\omega L - \frac{1}{\omega C} = b \dots (8)$$

with  $a$  and  $b$  as functions of  $\omega$ ,  $L$ ,  $C$ ,  $R$

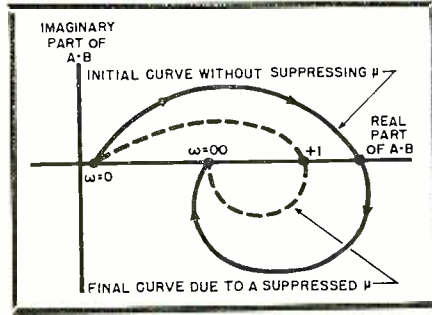

Fig. 3. Modified form of the Nyquist diagram for an oscillator.

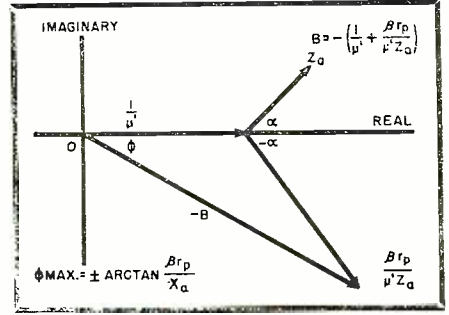

Fig. 4. Vector diagram showing requirements for oscillation.

and also of the characteristics of the oscillator tube. The frequency determined in this manner will differ from that determined by the reactances of the oscillator circuit. Since this calculated frequency includes the tube characteristics, a more stable oscillator will be achieved with circuit components selected so that the quantity  $b$  is zero. Then the formula for the frequency would reduce to

$$\omega^2 = \frac{1}{LC} \dots (9)$$

and as a result the frequency would be independent of the generating source. This requirement can be satisfied in a great number of ways and will be illustrated by numerous applications in this article.

This particular theory does not consider the presence and effects of harmonics in the circuit and upon the frequency of oscillation. Groszkowski has shown that in an oscillator operating under steady state conditions, there is a balance of both "actual" and "reactive" power. A balance of actual power is understood to mean a balance between the dissipated power in the resistive component of the load and that supplied by the power source. The reactive power balance also exists between the magnetic energy in the inductance and that in the capacitance of the tank circuit.

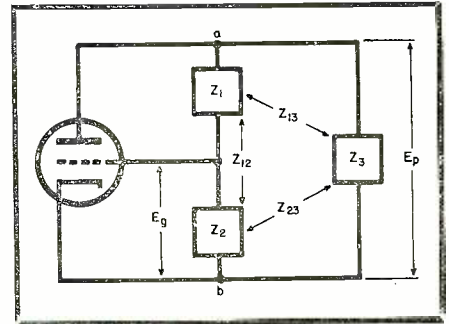

Fig. 5. Block diagram of general feedback oscillator with impedances indicated.

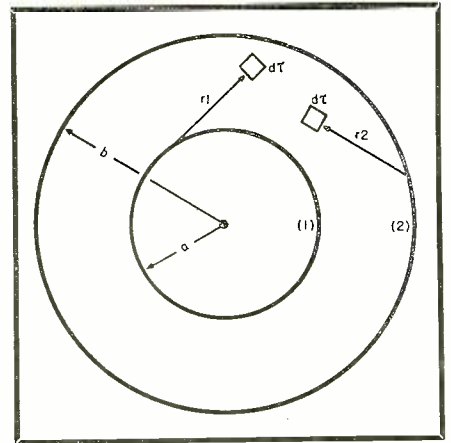
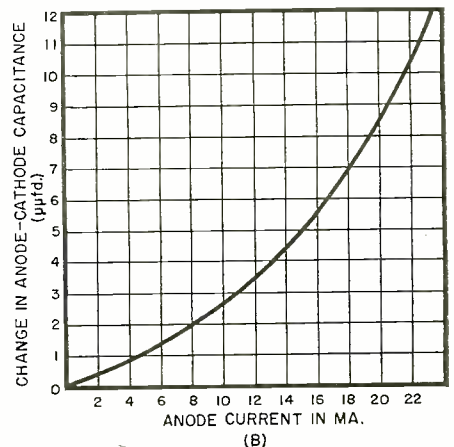
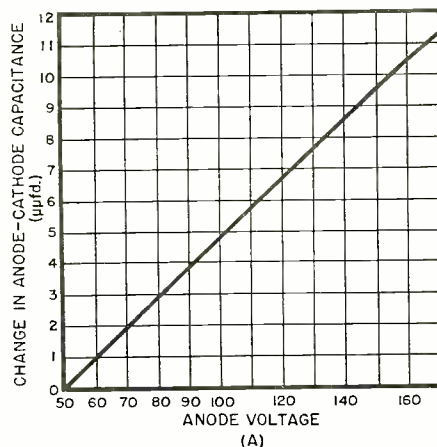

Fig. 6. An illustration of a spherical condenser with a charge distribution between the plates.

Fig. 7. Change in anode-cathode capacitance due to (A) anode voltage change, and (B) anode current change.



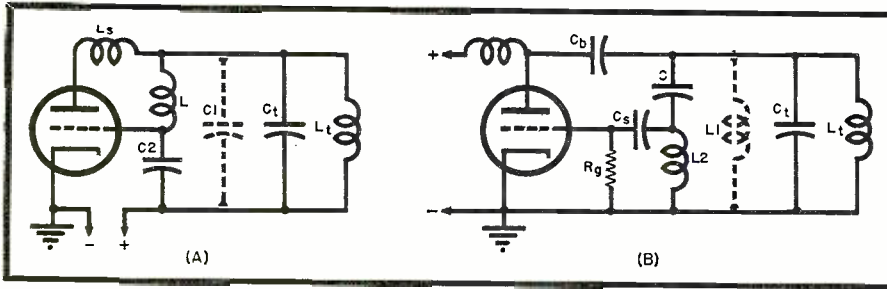

Fig. 8. Frequency stabilized oscillators. (A) Capacitively tuned tank circuit and a stabilizing inductance  $L_s$  equal to  $LC_2/C_1$ . (B) Inductively tuned tank circuit and a stabilizing condenser  $C_s$  equal to  $CL_1/L_2$ .

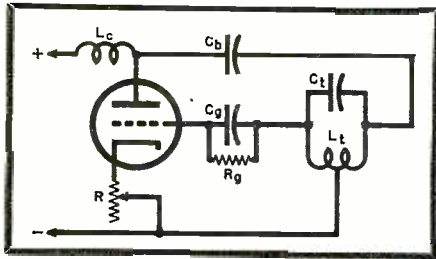

Fig. 9. Frequency stabilization with the aid of an adjustable cathode resistor.

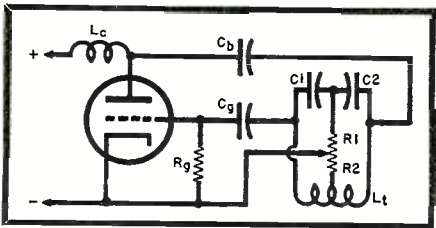

Fig. 10. Frequency stabilization by means of phase compensation.

The second power balance within the oscillation circuit was shown to be a necessary condition by Groszkowski, and the presence of harmonics of the fundamental tank current would cause the frequency to shift to a value which would produce a balance of power including the energy due to the harmonic fields. It clearly follows that any change in the harmonic content

of the oscillation current must introduce a change in the fundamental frequency.

To visualize the influence of the harmonics on the frequency of oscillation, consider the fact that the harmonic currents flow chiefly through the capacitive branch of the tank circuit and as a result the electrical energy in this branch is increased. To satisfy the condition of energy equilibrium, the frequency must decrease so that the electromagnetic energy in the inductive branch increases until a balance is obtained again between the energy in each arm. When this information is used for determining the effect of the harmonic content upon the fundamental frequency shift, it is found that a 1 per cent r.m.s. harmonic content of voltage across the tuning capacitance should give a reduction of frequency of about 50 cycles per million.

Another factor which is not easily taken into consideration and eliminated is the effect of a varying inter-electrode capacitance upon frequency drift. The capacitance between any two electrodes in a vacuum tube is dependent upon the geometry of the electrodes and the charge density between the electrodes. The dielectric in this particular case consists of a vac-

uum in which electrons or a charge density is located. The presence of the charge density definitely affects the capacitance. To understand this phenomenon, consider the simple geometrical arrangement of two concentric spherical electrodes with a charge distribution between them. The effect of the charge upon the capacitance in this arrangement will be similar to that encountered in other electrode configurations which will be illustrated by means of experimental test data.

Referring to Fig. 6, the difference of potential between the two surfaces is:

$$U_1 - U_2 = \int_{\tau} \frac{\rho}{\eta r_1} dr - \int_{\tau} \frac{\rho}{\eta r_2} dr + \int_{S_1} \frac{\sigma}{\eta r} dS - \int_{S_2} \frac{\sigma}{\eta r} dS \dots \dots \dots (10)$$

then:

$$U_1 - U_2 = \frac{Q}{\eta} \left( \frac{\alpha}{R_1} - \frac{\alpha}{R_2} + \frac{1}{a} - \frac{1}{b} \right) \dots \dots \dots (11)$$

where:

$$\frac{1}{R_1} = \frac{\int \frac{\rho dr}{r_1}}{Q} \dots \dots \dots (12)$$

$$\frac{1}{R_2} = \frac{\int \frac{\rho dr}{r_2}}{Q} \dots \dots \dots (13)$$

with  $\rho$  as the charge density between the electrodes and  $\tau$  and  $S$  as the volume and surface respectively. The quantity  $Q$  is the total charge on the surface of the electrodes and the net effective capacitance is given by the expression:

$$C = \frac{1}{\left( \frac{\alpha}{R_1} - \frac{\alpha}{R_2} + \frac{1}{a} - \frac{1}{b} \right)} \dots \dots \dots (14)$$

If the flow of electrons is increased in the anode circuit, due to an increase in anode voltage, the charge density will increase in the vicinity of the anode or surface  $S_2$  thereby causing the new denominator of Eq. (14) to become less and the value of the capacitance  $C$  to increase. This result was checked by experiment and is shown in the graph of Fig. 7A where the change in capacitance of a vacuum tube is plotted along the ordinate and the anode voltage is plotted along the abscissa. In this particular case the change in capacitance is almost linear with respect to the anode voltage. In another experimental check, the change in capacitance is again plotted along the ordinate but the anode current is plotted along the abscissa. This result is shown in Fig. 7B and is not linear. In each of these cases, the frequency of an oscillator would decrease if compensating or stabilizing networks were

Fig. 11. Performance tests of resistance-stabilized oscillator for (A) varying anode voltage and (B) varying filament voltage showing that 1830 ohms is best.

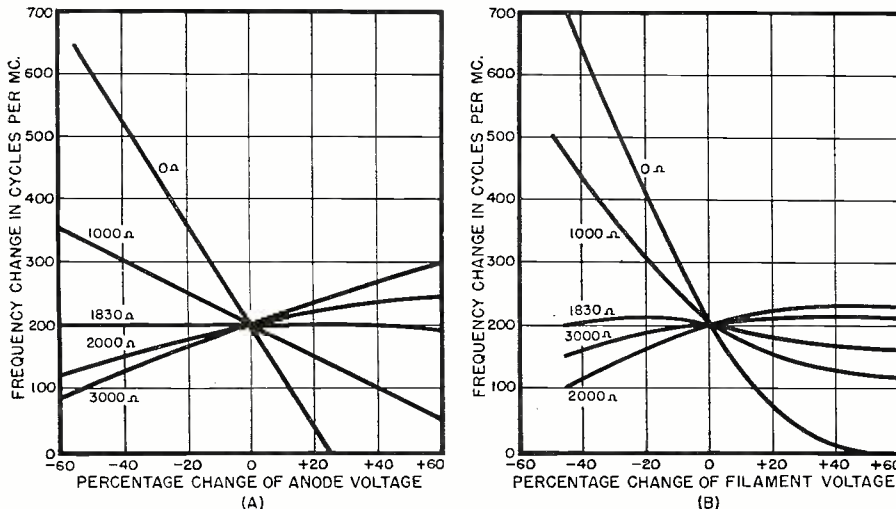

not included in the oscillator circuit.

A number of methods have been found for improving the frequency stability of an oscillator by connecting certain reactances in the electrode connections to eliminate or at least partially compensate the reactive effects of the tube. Referring to the basic circuit of Fig. 5, the condition of oscillation may be either expressed by Eq. (2) or (6). The well known circuits of Hartley, Colpitts, Meissner and Barkhausen are all represented with the aid of this circuit diagram and appropriate circuit element values. The frequency of oscillation of the particular circuit can be determined by setting the imaginary part of the product  $A \cdot B$  equal to zero.

For purposes of simplification and a first degree approximation, the numerical values of these compensating reactances can be calculated by assuming the circuit or tank resistance to be negligible compared with the plate resistance of the tube. This is certainly not correct for power oscillators but is reasonably correct for circuits not providing maximum power output. This assumption greatly simplifies the calculation of frequency and permits a rapid calculation of the reactances represented by  $Z_1$ ,  $Z_2$  and  $Z_3$ .

It has been found that frequency instability may be compensated for by several different methods. It is sufficient to indicate a number of successful methods used in conjunction with the tuned-plate, tuned-grid circuit, Hartley and Colpitts oscillator circuits. These methods are shown in Fig. 8 where the value of the compensating inductance  $L_s$  or capacitance  $C_s$  is given for each circuit in terms of the parameters of the circuit.

If stabilization of the oscillator is accomplished by a capacitive reactance in series with the anode circuit, it is necessary to provide a d.c. path for the steady plate current. This can be achieved by shunting the frequency stabilizing capacitance with a high impedance choke.

The stabilizing capacitance which must be used with a tuned-plate, tuned-grid oscillator or a Hartley oscillator, is proportional to the capacitance of the tuned circuit. If it is desirable to stabilize the circuit over a wide band of frequencies, this relation can be obtained by connecting the two condensers together mechanically.

It has been found by experiment that considerable improvement in frequency stability can be obtained by selecting the appropriate circuit values. As an example, in the case of a small power oscillator, a shunt-fed tuned-plate and a plate circuit stabilizing resistance, a 10 per-cent decrease in filament current introduced a decrease in frequency

of 25 cycles per megacycle and a 10 per-cent drop in plate voltage increased the frequency 15 cycles per megacycle. It is interesting to note that the two frequency variations were of the opposite sign; however, the frequency change due to the change in heater current was considerably more than that due to a corresponding percentage change in the plate voltage. This fact may be used to advantage by having both voltage supplies derived from a common source thereby introducing a certain amount of automatic compensation.

It is quite obvious that power oscillators, in general, cannot be designed for maximum power output and frequency stability simultaneously by selecting an appropriate ratio of  $L/C$ . The ratio  $L/C$  for a power oscillator is  $R_L^2/Q^2$ , where  $Q$  is the ratio  $\omega L/R$  of the loaded tank coil and  $R_L$  is the load resistance which should be applied to the plate circuit of the power oscillator tube. In practice, the numerical value of  $Q$  can not always be reduced with ease, in each case, to values less than 30 and the value of  $R_L$  determined by the operating characteristics of the tube. If, however, maximum power output is not of importance, it is possible to choose an  $L/C$  ratio which will give a frequency stability better than 100 cycles per megacycle for intentional changes in plate voltage of 10 per-cent.

In addition to the methods of frequency stabilization shown in Fig. 8, there are a few methods which have proven very satisfactory in practice. A circuit such as that shown in Fig. 9 might be called a resistance-stabilized oscillator because the resistance produces an inverse feedback effect. In particular, resistance  $R$  provides a bias voltage in the grid circuit proportional to the steady cathode current. The family of curves plotted in Fig. 11

Fig. 13. Performance of phase-compensated oscillator with variations in filament voltage for optimum values of  $R_1$  and  $R_2$ .

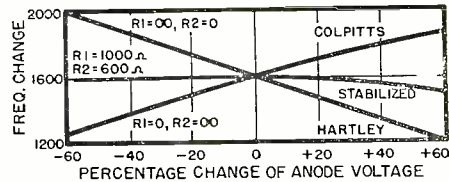
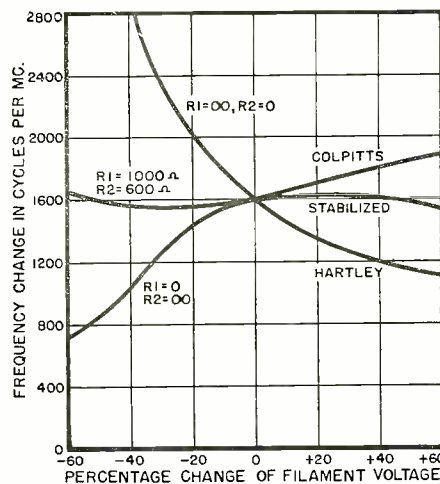

Fig. 12. Performance of phase-compensated oscillator with variations in anode voltage for optimum values of  $R_1$  and  $R_2$ .

indicates very definitely the stabilizing effect of increasing the resistance of the cathode resistor. It is observed that the frequency change for a decreasing plate voltage or filament potential may be reversed in sign by adjusting the controlling resistance. By carefully selecting the numerical value of the resistance, it is possible to make the frequency substantially independent of the tube parameters. In this case, a resistance of 1830 ohms gave the best performance of about 15 cycles per megacycle for a very wide range of supply voltages. It should also be realized that the cathode resistor provides only a part of the grid bias voltage and that a reasonably high grid resistance is necessary in order to provide a self-biasing circuit for the oscillator.

Another very interesting method of frequency stabilization applies the principles of phase-compensation to a circuit which combines the features of the Hartley and Colpitts oscillators, since the frequency variations in a Hartley oscillator are in the opposite direction to those occurring from the same cause in the Colpitts oscillator.

With the aid of Eq. (4), it is possible to show that for a Hartley oscillator the frequency of oscillation is always lower than the resonant frequency of the tank circuit and since the frequency difference is inversely proportional to the tube resistance  $R_p$  and

(Continued on page 28)

Fig. 14. Variation of power supplied to work coil due to changing load impedance.

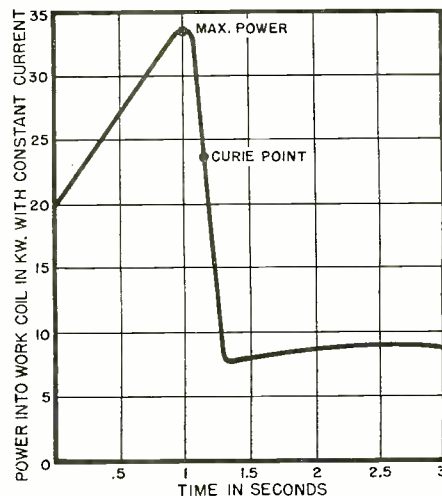

# A SINGLE-STROKE OSCILLOSCOPE SWEEP

By  
**ALBERT H. TAYLOR**

## ***Design, theory of operation, and typical circuit for a single-stroke sweep operating from center position.***

COMMON types of single-stroke sweeps require a cathode-ray oscillograph deflection amplifier to deliver twice the peak output voltage necessary with sinusoidal or sawtooth deflection. As a result, overloading and consequent nonlinearity are probable. A very fast single-shot sweep circuit avoids this difficulty. Starting from screen center, it jerks to the left edge and commences sweeping within 0.1 microsecond after tripping, and simultaneously flashes on the normally extinguished cathode-ray beam just long enough for the spot to traverse the width of the screen. Applications both as a sweep for very fast transient studies and as a high-speed chronograph are possible.

Single-stroke sweeps in common use are generally of two types; either the spot is positioned to the left and swept across once from left to right upon triggering, or it is positioned to the right and when triggered is jerked across quickly to the left before sweeping from left to right. If no intensity-grid control is provided, the spot, in both cases, is positioned entirely off the screen. It is much better to cut off the beam and merely flash it with a single square pulse, lasting as long as the spot takes to traverse the screen and applied to the intensity electrode.

Sweep voltages are generally applied to the deflection plates through an  $x$ -axis amplifier. This is done because amplification is usually needed; push-pull deflection is desirable for most cathode-ray tubes but is awkward to get directly from a sweep circuit, and because the amplifier is usually available anyway. Unfortunately, a side-positioned single-stroke sweep as described above requires the  $x$  amplifier

to handle, without distortion, *twice* the peak voltage which would be required for full-scale sinusoidal deflection. Since high writing speed requires high intensity and high intensity requires high deflecting voltage, the wide-band deflecting amplifier is apt to be already taxed to the limit even by full-scale sinusoidal or repeated sawtooth deflection. The side-positioned single-stroke sweep will overload it. To be sure, it is possible to prebias the amplifier stage by stage, but this requires considerable switch-gear and may exceed tube dissipation ratings. The circuit described here operates with the spot positioned at center. When tripped it simultaneously turns on the cathode-ray beam and jerks the spot very quickly to the left. The spot then moves all the way across the screen to the right, and is extinguished when it reaches the righthand edge.

Fig. 3 shows a complete circuit providing sweep, spot control and chronograph. When it is used, the manual intensity control of the cathode-ray oscillograph is set well below spot extinction, the amplifier gain is adjusted so that the trace just reaches the left edge of the screen, the sweep

Fig. 1. (A) Basic sweep circuit.  
(B) Simplified circuit for analysis.

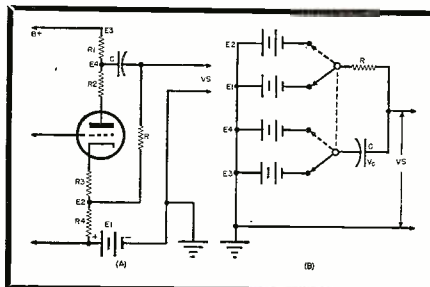

speed in centimeters per second is determined by  $R_6C_2$ , and  $R_5C_1$  and Bias 2 are set so that the trace ends (by spot extinction) just at the righthand edge of the screen. While these adjustments are being made, the sweep is of course repeatedly operated by pushing the hand tripping button. It must be recognized that this is strictly a single-shot sweep; after every operation the second thyatron remains fired and conducts a current limited by  $R_1$  plus  $R_2$  plus whatever other resistance is in the  $B$  supply circuit. The sweep must be recocked by interrupting the  $B$  supply either manually, or automatically with a simple relay circuit. For the fastest work,  $R_1$ ,  $R_2$ ,  $R_3$ , and  $R_4$  are chosen to limit the tube current to the instantaneous peak rating, a large condenser is connected from the  $+B$  of Fig. 3 to ground, and the  $B$  supply voltage is fed to the system thru a resistance sufficient to limit the current to the continuous tube rating. The coil of a recocking relay can well provide this resistance.

In actual operation, depending on the particular application, the sweep is tripped either manually (in cases where a pulse from the sweep circuit can initiate the phenomenon to be studied), or automatically, by applying a steep positive pulse to "Tripping No. 1". For example, in explosion wave studies, the sweep can be tripped by a microphone placed nearer to the explosion than the actual pressure gauge. If the second thyatron, instead of being fired a predetermined time after the first, is tripped by a second external event which applies a positive pulse to "Tripping No. 2", the device serves to measure accurately the time between the two events, even if it is only a few microseconds.

This timer was used by the author some years ago in conjunction with a spiral sweep which gives a very long timing trace, its angular length a measure of the time interval. It is extremely quick-acting if  $R_1$ ,  $R_2$ ,  $R_3$ , and  $R_4$  are kept as low as the peak current ratings of the tubes permit. Harrison<sup>1</sup> has measured the firing time of the 885 as 0.08 microsecond. Needless to say, a wide-band deflection amplifier with good transient characteristics is necessary to realize the full possibilities of the sweep of Fig. 3. When, however, the spot control feature is employed as a chronograph, using as time base either the linear sweep which Fig. 3 provides, or a crystal-controlled circle or spiral, very short time constants are necessary only in the intensity circuit.

Consider the simplified figure, 1B. Equations derived for it apply also to

<sup>1</sup> Harrison, A. E., "Ionization Time of Thyatrons", *A.I.E.E. Trans.* 59, p.747, 1940.

1A and to Fig. 3, provided  $R$  is large compared to  $R_1, R_2, R_3,$  and  $R_4$ .

The following voltages are defined as:

$V_c$  = voltage across the condenser  $C$  at any time  $t$ .

$V_{c00}$  = value of  $V_c$  before switching (or firing thyatron)

$V_{c0}$  = value of  $V_c$  immediately after switching

$V_\infty$  = value of  $V_c$  an infinitely long time after switching

$V_s, V_{s0}, V_{s00}, V_{s\infty}$  = voltage across sweep output between  $RC$  junction and ground, at the same respective times

$v, v_{00}, v_0, v_\infty$  = voltages to ground on the other side of a large blocking condenser, shown in Fig. 3 but not in Fig. 1.  $v$  is of course the sweep voltage actually applied to a deflection amplifier.

Before switching:

$$V_c = V_{c00} = E_1 - E_3 \dots (1)$$

$$V_s = V_{s00} = E_1$$

$$v = v_{00} = 0$$

An infinitely long time after switching, when  $t = t_\infty$ :

$$V_c = V_{c\infty} = E_2 - E_4$$

$$V_s = V_{s\infty} = E_2 \dots (2)$$

$$v = v_\infty = V_{s\infty} - V_{s00} = E_2 - E_1$$

Of course, in practice  $t_\infty$  is not infinite, but of necessity  $RC \ll t_\infty \ll T_{LF}$ , where  $T_{LF}$  is the low-frequency time constant of the deflection amplifier and coupling system, resulting from interstage coupling condensers and grid resistors, etc., and determining the low-frequency cutoff.

Consider the switch thrown instantaneously. Immediately after switching:

$$V_c = V_{c0} = V_{c00} = E_1 - E_3$$

$$V_s = V_{s0} = E_4 + V_{c0} = E_1 - E_3 + E_4 \dots (3)$$

$$v = v_0 = \Delta V_s = V_{s0} - V_{s00} = E_1 - E_3 + E_4 - E_1 = E_4 - E_3$$

The relationships in Eqs. (1), (2) and (3) can be seen by inspection.

Following switching, the usual exponential equation holds:

$$v = v_0 + (v_\infty - v_0) (1 - e^{-t/RC}) = (E_4 - E_3) + [(E_2 - E_1) - (E_4 - E_3)] (1 - e^{-t/RC}) \dots (4)$$

$$v = v_\infty - (v_\infty - v_0) e^{-t/RC} = (E_2 - E_1) - [(E_2 - E_1) - (E_4 - E_3)] e^{-t/RC} \dots (5)$$

Similar equations of course apply to  $V_c$  and  $V_s$ .

Of the two expressions (4) and (5), Eq. (4) is the more readily visualized as the source of the sweep voltage-vs.-time graph of Fig. 2. In Fig. 2,  $v_0 = E_4 - E_3$  is the first sharp jerk of voltage, and  $(v_\infty - v_0)$  is the coefficient of the exponential function. If  $R$  and  $C$  are connected as shown to points marked  $E_2$  and  $E_4$  in Fig. 1A, the sweep voltage

will be as shown in Fig. 2; if they are interchanged, Fig. 2 will be inverted. Normally the polarity would be chosen to jerk the spot to the left and sweep it to the right. If the spot is initially positioned at the center of the screen and the amplifier gain is such that the trace just reaches the left edge on the first jerk, it will reach the righthand edge when  $v = -v_0 = E_3 - E_4$ . If Eq. (4) is solved for  $t$ , it becomes:

$$t = RC \log \frac{v_\infty - v_0}{v_\infty - v}$$

$$t_1 = RC \log \frac{v_\infty - v_0}{v_\infty + v_0} \dots (6)$$

when  $v = -v_0$

and expresses the time  $t$  at which any voltage  $v$  is developed. This equation serves as a basis for computing the  $RC$  values for a practical multispeed sweep. The constant factor  $(v_\infty - v_0) / (v_\infty + v_0)$  is fixed in Figs. 1A and 3 by the relative values of  $R_1$  and  $R_4$ .

Differentiate Eq. (4) with respect to time:

$$\frac{dv}{dt} = \frac{1}{RC} (v_\infty - v_0) e^{-t/RC} \dots (7)$$

when  $t = 0$ ,

$$\left(\frac{dv}{dt}\right)_{t=0} = \frac{1}{RC} (v_\infty - v_0) \dots (8)$$

when  $t = t_1$ ,

$$\left(\frac{dv}{dt}\right)_{t=t_1} = \frac{1}{RC} (v_\infty + v_0) \dots (9)$$

The ratio of (8) to (9) is:

$$\frac{v_\infty - v_0}{v_\infty + v_0} \dots (10)$$

Thus the relation of  $v_\infty$  and  $v_0$ , that is of  $(E_2 - E_1)$  and  $(E_4 - E_3)$ , hence of  $R_1$  and  $R_4$ , is determined by equating  $(v_\infty - v_0) / (v_\infty + v_0)$  to one plus the proportional deviation from linearity which

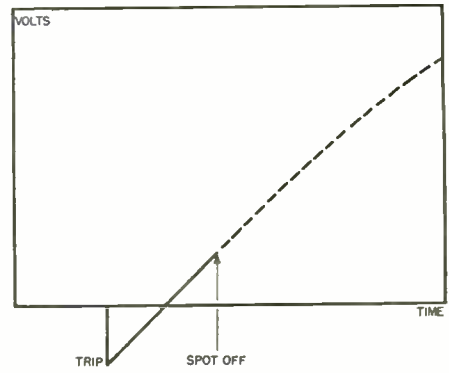

Fig. 2. Plot of voltage vs. time for the single-stroke sweep.

can be tolerated between start and finish of the sweep trace. For example, if 5% nonlinearity is permitted:

$$\frac{v_\infty - v_0}{v_\infty + v_0} = 1.05, \text{ or}$$

$$v_\infty - v_0 = 1.05 (v_\infty + v_0) \dots (11)$$

Solving for  $v_\infty$  gives:

$$v_\infty = -41 v_0 \dots (12)$$

Nonlinearity may be decreased in direct proportion to  $R_1 R_4$ , so long as  $iR_1$  is enough to give the needed deflection.

Typical values for Fig. 3 are  $+B = 250$  volts regulated,  $-BIAS = -90$  volts regulated,  $i = 50$  ma. while first thyatron conducts; 340 ma. after second fires and quenches first. An 80 microfarad, 450 volt condenser across  $+B$  of Fig. 3 is fed thru a 2500 ohm relay coil. This relay opens when the condenser has discharged sufficiently through  $R_1$  plus  $R_2$  and the second tube to draw operating current thru relay coil. This relocks the sweep.  $R_4 = 200 R_1$ , hence the nonlinearity is 2010/1990 minus one, or 1%.

Fig. 3. Complete circuit providing sweep, spot control and chronograph.

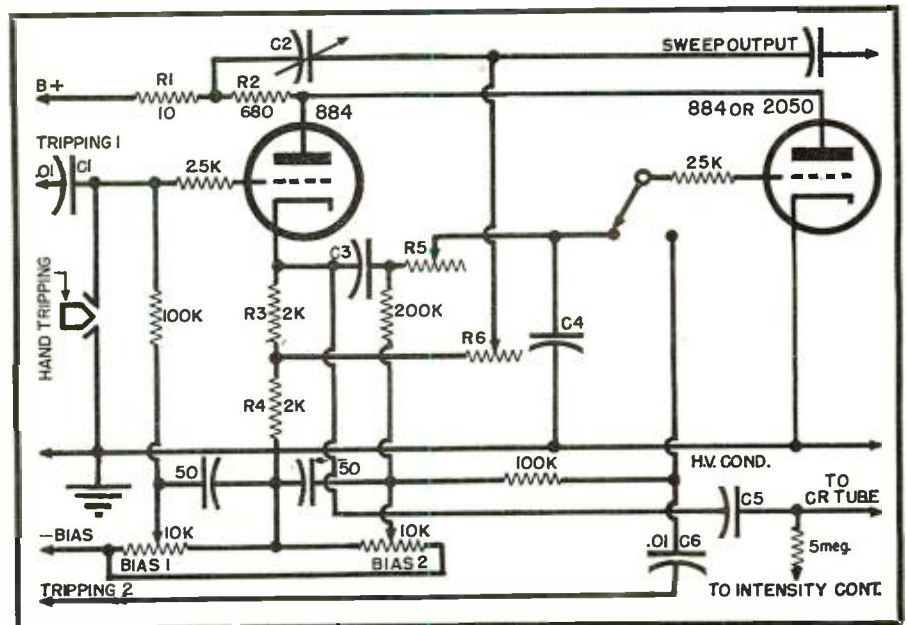

# PULSE COMMUNICATION SYSTEMS

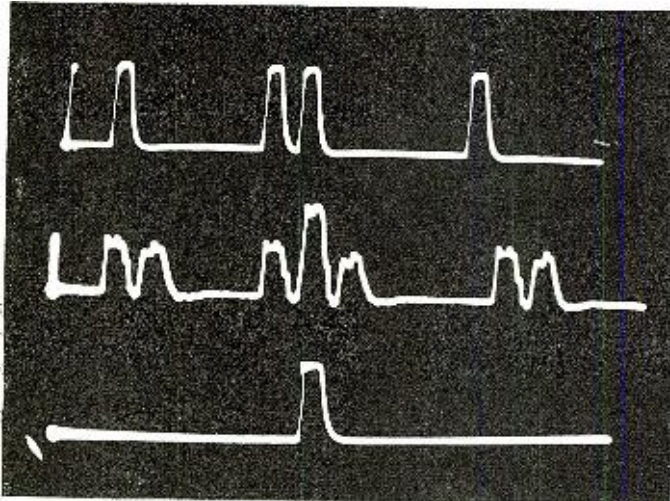

Fig. 1. Oscilloscope trace of single marker pulse being formed from double pulse.

By  
**SIDNEY MOSKOWITZ**  
and **JOSEPH RACKER**

Federal Telecommunication Labs.

**Part 7 discusses various communication systems utilizing pulse modulation.**

COINCIDENT with the expanding demand for communication services is the increase in importance and range of the multiplex operation. Multiplexing, or simultaneous transmission of more than one channel on a common carrier, is one of the first methods considered when traffic on any line exceeds the capacity of the equipment. Pulse systems can easily be multiplexed—hence the increasing importance of pulse techniques in the field of communications.

Simultaneous transmission of a multiplicity of channels may be accomplished in one of two ways. One system, known as the frequency-division method, identifies each channel with a separate sub-carrier frequency. Each message modulates the sub-carrier identified with its channel. The modulated sub-carriers are then either combined directly for wire transmission or used to modulate an r.f. carrier for radio application. At the receiver terminal, these channels are then separated by frequency selection and the sub-carrier filtered out, restoring the original message signal. A serious problem in this system is cross-modulation introduced by distortion, particularly in relaying over long distances.

The second system of multiplexing is known as time-division multiplexing. In this case, samples of each channel are transmitted in time sequence. That is, the instantaneous amplitude of the first channel signal is sampled and transmitted. Then the instantaneous amplitude of the second channel is trans-

mitted. When all channels are sampled, the process is repeated. The frequency of sampling or the scanning rate for each channel is dependent upon the message bandwidth to be transmitted. For voice transmission, the scanning rate is of the order of 8000 per second.

This rate is rapid enough to prevent the listener from detecting any perceptible difference between what he hears and normal sound. It is an effect similar to that which the eye experiences when witnessing motion pictures. In this case, since only one increment of the modulation signal is transmitted at any one instant, non-linearities in the transmission system do not introduce inter-channel crosstalk products such as would be obtained in the frequency division method.

Fig. 2. Graphic illustration of noise reduction through use of clipper and limiter in constant amplitude pulse systems.

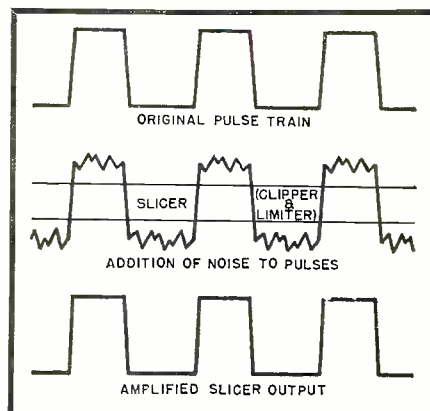

Any method of pulse modulation necessarily uses sampling, hence the ease with which it can be multiplexed by means of time division. When the two are combined, i.e. time division with pulse modulation, the resultant system is called pulse time multiplex. This system exhibits many important characteristics which make the method particularly applicable in communication service. These characteristics are:

1) Improved crosstalk or interference between channels at both receiver and transmitter for reasons outlined above.

2) Simplification and economy in terminal design by eliminating the need for complex filter networks.

3) Improved signal-to-noise potentiality which is characteristic of most types of pulse modulation. Limiters and other noise reducing devices may be utilized effectively.

4) When repeaters for extending the range of transmission are used, the inherent on-off characteristic of pulse modulation allows a simplified repeater system to be employed.

5) Flexibility of the pulse function which permits various transmission constants to be interchanged, for example bandwidth for signal-to-noise ratio, crosstalk for bandwidth, number of channels for signal-to-noise ratio and other combinations—thus allowing a design directly suited to the specific application.

Since pulses are characterized by several parameters including amplitude, timing, duration, frequency, build-



up time, decay time, and pulse shape, a large number of modulation methods utilizing these characteristics, either singly or in combination, may be envisaged. For example the amplitude may be modulated, resulting in pulse amplitude modulation or PAM. Alternatively the width or duration of the pulse can be made to vary in accordance with the modulation signal resulting in pulse width modulation (PWM). In this case, a variation of average power similar to amplitude modulation is obtained but with constant amplitude pulses which permits noise reduction advantages through the use of clippers and limiters as shown in Fig. 2.

Instead of varying the individual pulse characteristic, the time between pulses or with reference to a marker pulse can be varied, resulting in pulse position modulation (PPM). In this case, the same noise reduction advantages can be gained as in the PWM system, but with considerable reduction in average power for the same peak power realized. Pulse frequency modulation, PFM, is a system wherein the frequency of the pulses is varied in accordance with the modulation. Here, as in PPM, the average power is essentially constant. In another system—PCM—an entirely new approach is taken and a quantized or count type of modulation is used. These different types of modulation are shown graphically in Fig. 3.

The other pulse characteristics, such as pulse shape, as well as combinations of any of them, such as time modulation together with amplitude modulation of a series of pulses, may also be employed to transmit the intelligence. Each system has its advantages and disadvantages and the one used will depend mainly upon the individual application.

It is obviously beyond the scope of this article to cover all of these systems. Discussion, therefore, will be limited to two of the more common methods of pulse modulation, namely, pulse amplitude modulation, PAM, and pulse position modulation, PPM.

### Commutation

Fundamentally any pulse time multiplex equipment must consist of the following stages: commutation, modulation, synchronization, channel separation, and demodulation. The first of these, commutation, may be accomplished in a number of ways—all of which are virtually independent of the type of modulation employed.

Where a very low scanning rate may be utilized, the system shown in Fig. 4 may be used. In this system, there are two switches—one at the sending end

and one at the receiving end. The speed and position of these switches can be synchronized, so that when the sending switch is at position 1, the receiving switch is at position 1, and likewise for each successive position. Hence the signal generated while the sending switch is at position 2, is received only by the circuit associated with position 2 at the receiving end. As the switch completes a revolution each channel is sampled, transmitted, and received by the appropriate circuit. The scanning rate is, of course, equal to the rotation frequency of the switch.

It will be shown subsequently in this article that the scanning rate must be at least twice the highest audio frequency transmitted so that it can be filtered out adequately at the receiver.

Hence for voice frequency multiplexing, the channel pulse repetition rate required far exceeds the capabilities of the mechanical switch, shown in Fig. 3, and requires the use of electronic methods. One method employs an electronic switch, such as the Cyclophon, instead of a mechanical one. The Cyclophon is a cathode ray tube whose beam is caused to describe a circular path. The beam is collected by each of a number of target anodes, as shown in Fig. 9, arranged around a circular path. In operation, the tube acts as a switch with a particular collector being 'on' while the beam is focused on it.

The commutation process may also be achieved through the use of a tapped delay line. Such a line may be of the spiral distributed or lumped constant type. In operation, a pulse at the scanning frequency is fed into the line and each channel pulse is obtained in its

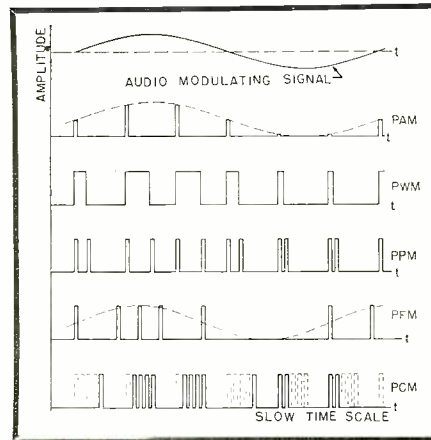

Fig. 3. Pulse modulation methods.

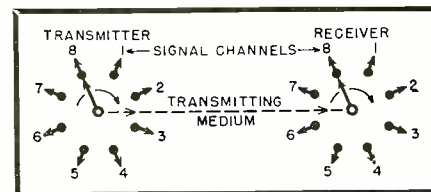

Fig. 4. Low speed commutation system using synchronized mechanical switches.

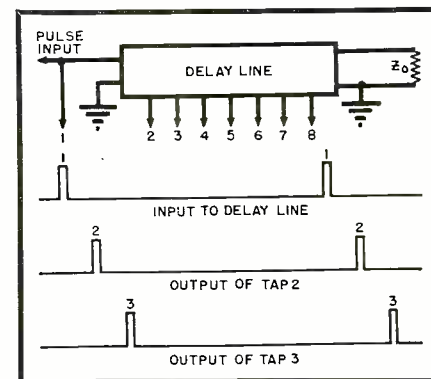
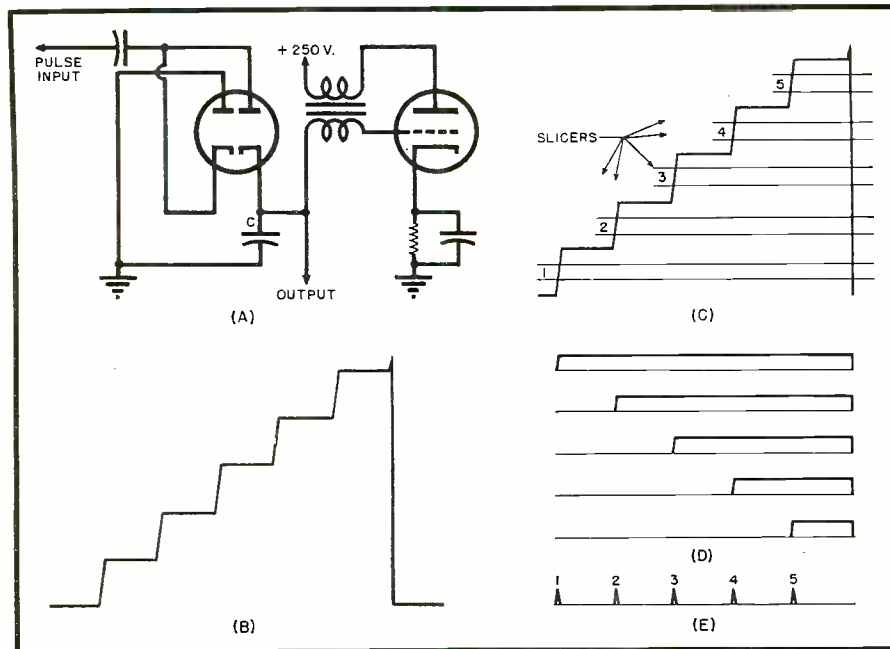

Fig. 5. Delay line commutator.

Fig. 6. (A) Schematic diagram of a counter circuit and (B) its output. (C), (D) and (E) Step voltage commutator waveforms.



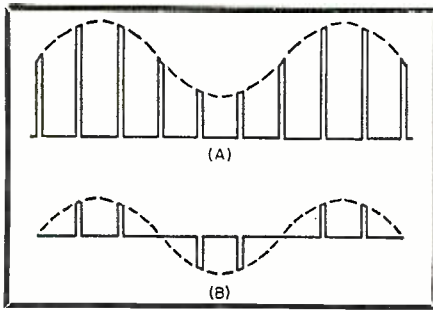

Fig. 7. Diagram showing two types of pulse amplitude modulation.

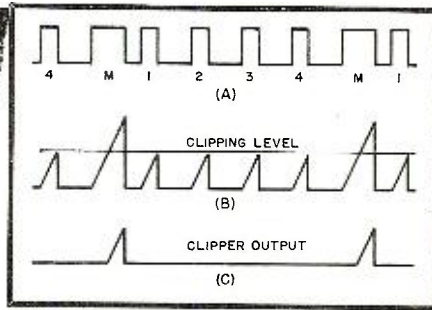

Fig. 8. Method of separation of a wide marker pulse.

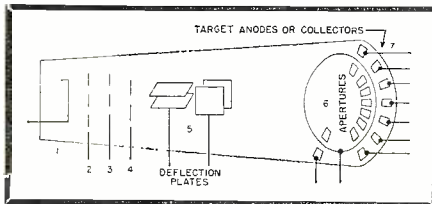

Fig. 9. Cyclophon commutator tube — an electronic switch.

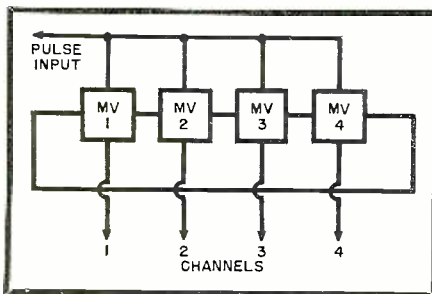

Fig. 10. Multivibrator ring circuit used for commutation.

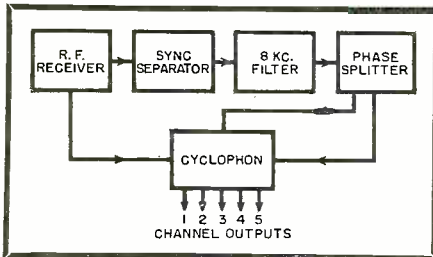
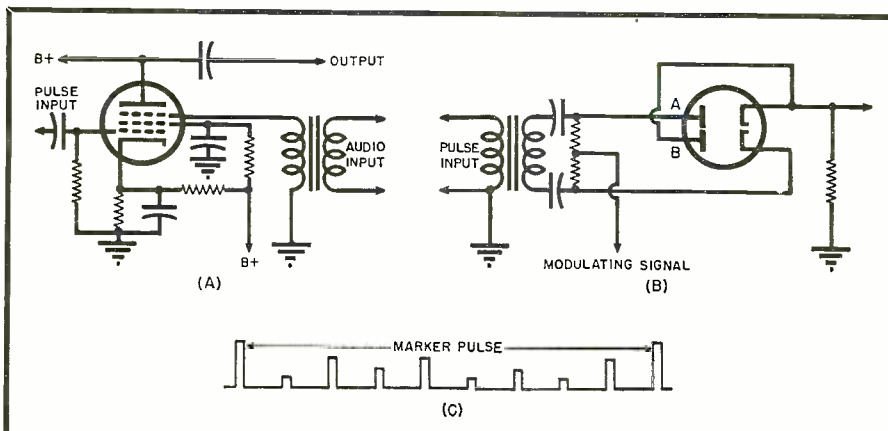

Fig. 11. Cyclophon channel separator and demodulator.

Fig. 12. (A) Unidirectional and (B) bidirectional PAM modulator. (C) Typical 8 channel PAM pulse train, showing marker pulses.



vious article<sup>1</sup>, is a voltage which increases in steps as pulses are applied to its input—each pulse causing a step increment of voltage. This voltage increases until it is sufficiently large to fire the blocking oscillator—at which point condenser *C* discharges and returns the voltage to zero. The waveform of the counter output is shown in Fig. 6B and is known as a step voltage.

This step voltage is then fed to a series of slicers which are biased so that slicer 1 cuts through step 1, slicer 2 through step 2 and so on as shown in Fig. 6C. It is obvious from this figure that the voltage output of slicer 1 initiates with step 1 and terminates when the step voltage returns to zero, while the output of slicer 2 initiates with step 2 and terminates when the step voltage returns to zero and so on for all the other slicers. This is shown in Fig. 6D. The output of these slicers is then differentiated—providing a narrow pulse during the build-up and decay times of the input voltage—and then clipped—to remove the negative pulses—resulting in a series of pulses spaced equally in time as shown in Fig. 6E.

### Modulation

The series of pulses obtained from the commutator are usually equally spaced and shaped. Each channel pulse is then individually varied, either in time or amplitude, depending upon the type of modulation employed, in accordance with the applied audio signal. In a PAM system, two types of amplitude modulation may be utilized. In one, known as unidirectional PAM, all pulses are of one polarity; whereas in the other, known as bidirectional PAM, the amplitude of the pulse is positive and negative—with the average value equal to zero. These two types of PAM are shown graphically in Fig. 7.

Unidirectional amplitude modulation may be accomplished by using a multi-grid tube, wherein the pulse series is fed to one grid and the audio signal to another. The gain of the amplifier, and hence the magnitude of the pulse appearing in the plate circuit, is controlled by the modulation signal. The output of this circuit, shown in Fig. 12A, will therefore be a series of pulses whose amplitudes are proportional to the modulation signal—but always of the same polarity.

Bidirectional PAM may be obtained through the use of a balanced modulator shown in Fig. 12B. In this circuit, the pulses are fed in opposite polarity to the diodes so that they cancel each other in the load resistor when no modulation signal is present. However, during the presence of the pulse, both diodes conduct, charging up the two condensers. In the absence of the pulse

—due to the high  $RC$  constant of the circuit—each condenser, being charged, provides a bias of such polarity as to cut off the diode associated with it. The effect is similar to that described for the peak riding clipper in a previous article<sup>2</sup>. The diodes are therefore each biased by a negative voltage equal to the peak pulse value. The modulating signal never exceeds this bias, and hence no signal appears across the output of this circuit in the absence of a pulse input.

When a pulse is applied across the input, both diodes are driven to zero potential and therefore are primed to conduct—with the polarity of the modulating voltage the controlling factor. If the modulation voltage is positive, diode  $A$  conducts allowing a positive pulse, with an amplitude equal to the audio signal level, to appear across the load. If the modulation signal is negative, diode  $B$  conducts, allowing a negative pulse, equal to the modulating amplitude, to appear across the load.

Both the unidirectional and bidirectional modulators are cut off between pulses. As a result, the channel pulses may be mixed by utilizing a common load resistor for all modulators. A typical 8 channel train of amplitude modulated pulses is shown in Fig. 12C.

Pulse position modulators are more complex than amplitude modulators since a voltage variation must be transformed into a proportional time position modulation. Fig. 13A is a circuit which can be used to effect this modulation. In this circuit, the triangular pulse of Fig. 13B, derived from a commutating circuit such as the previously described delay line, is fed to a slicer. The modulating signal is added to the triangular pulse, as indicated in Fig. 13C, so that the pulse is raised and lowered through the slicing level by the signal. A pulse is thus formed whose leading edge varies in time. If the triangular pulse has a linear slope, the resulting pulse edge timing will be proportional to the modulation voltage. Upon differentiating, this width modulated pulse is replaced by a narrow pulse modulated in time position as shown in Fig. 13D.

The compensating  $RC$  network shown in Fig. 13A is used to prevent the pulse circuit from loading the audio source.  $V_1$  and  $V_2$  comprise the slicing circuit where  $V_1$  is biased to clip normally half way up the triangular pulse. As the modulation voltage is introduced, the clipping level moves up and down around this point.  $V_2$  is driven to cutoff so that its plate current is trapezoidal. The plate inductance,  $L$ , accomplishes the differentiation process.

Several variations of this circuit may be used, such as employing two triodes in a multivibrator circuit to obtain

rapid triggering and hence sharper slicing. In some cases the commutation and modulation process can be combined. For example if the step voltage commutation is used, the slicers for each channel may be made to vary in accordance with the modulation. The output of this circuit would therefore be a number of separate channels, each channel time position modulated.

### Synchronization

An important requisite of pulse time multiplex systems is an accurate synchronization, in frequency and phase, of the receiver commutator circuits with those of the transmitter. This process is accomplished by allotting one pulse, i.e. one channel, for synchronization purposes. In a PAM link, the synchronizing or "marker" pulse may be made larger than the peak amplitude of the other channel pulses. The marker pulse may then easily be separated from the others at the receiver by means of a clipper. After detection, the pulse is then used to actuate the commutator circuits in a manner similar to the 'sync' circuits in a television receiver.

In constant amplitude systems, such as PPM, other means must be used to identify the marker—since the constant amplitude characteristic of the pulse train is a highly desirable characteristic of the system (to reduce noise level). Synchronization, in these systems, may be achieved by making the marker pulse wider than all of the others. A typical 4 channel PPM pulse train using this type of marker is shown in Fig. 8A. At the receiver the marker pulse is separated from the others by means of an integration circuit. In this circuit, as previously described<sup>3</sup>, the output amplitude is proportional to the width of the pulse, so that the marker pulse has a larger amplitude than any of the other channel pulses as shown in Fig. 8B. After clipping a pulse is obtained at the basic scanning frequency which is then used to synchronize the receiver.

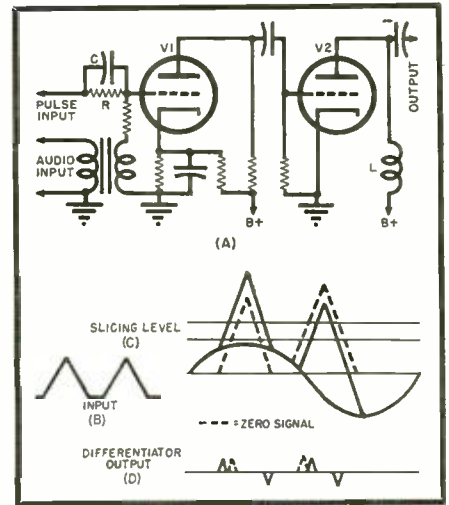

Fig. 13. PPM modulator.

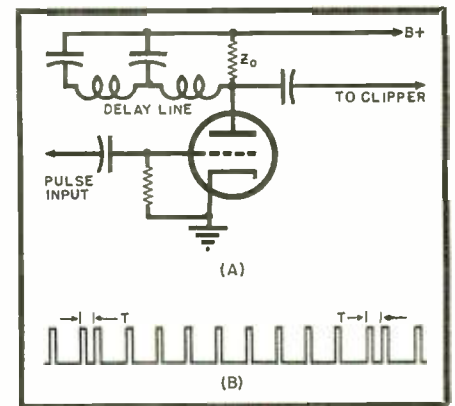

Fig. 14. Delay line double marker pulse separator.

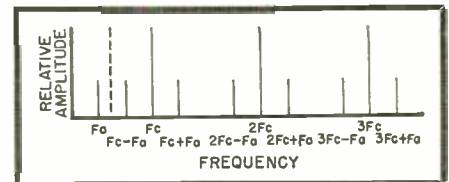
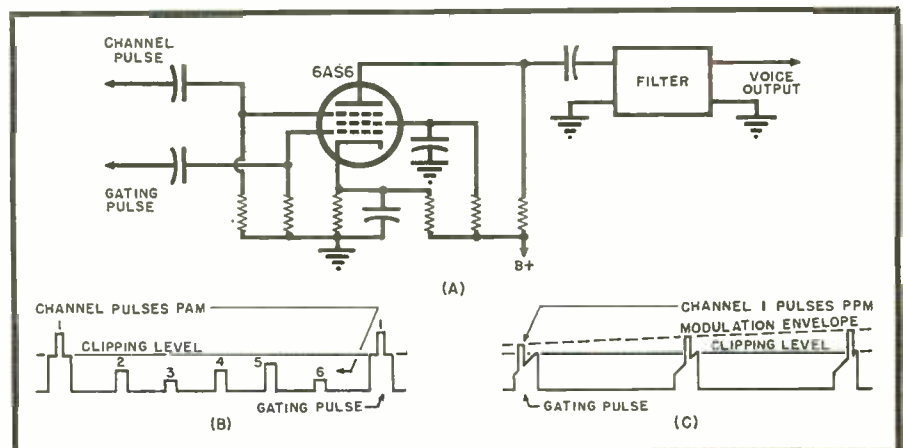

Fig. 15. Frequency spectrum of a unidirectional PAM. Bidirectional has the same spectrum minus the carrier frequency and harmonics but with the carrier sidebands.

Fig. 16. Channel separation and demodulation of PAM and PPM trains.



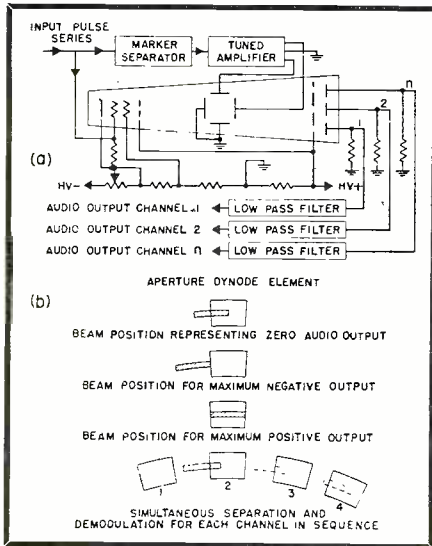
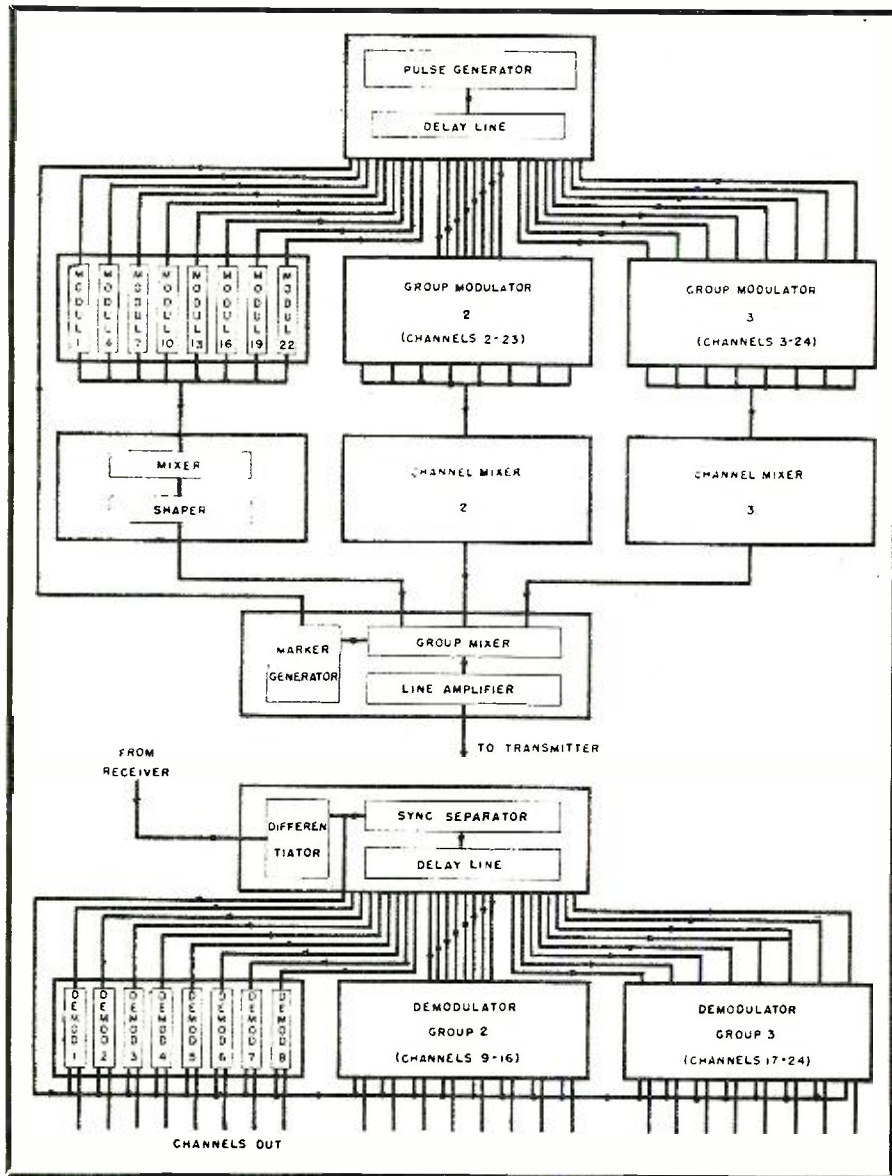

Fig. 17. PPM Cyclophon channel separator and demodulator.

An alternative method, which does not rely upon the shape of the pulses,

but on the number and spacing, is through the use of a double marker pulse with a fixed time spacing between the two pulses, as shown in Fig. 14B. This spacing,  $T$ , is made smaller than the minimum spacing possible between any other two pulses. At the receiver, the pulse train is fed with negative polarity to the circuit of Fig. 14A. An open ended delay line, whose time length is exactly one half the time spacing between marker pulses, is inserted in the plate circuit. The incoming pulses, now positive in polarity, are forwarded down the delay line. The pulses are reflected at the open end and arrive back at the plate  $T$  seconds after they entered. At the time that the second marker pulse is impressed across the line, the first reflection appears at the same terminal. The two pulses add, forming a pulse of greater amplitude which may then easily be detected by a clipping circuit. An oscillograph of this operation is shown in Fig. 1.

Fig. 18. Block diagram of FTL 24 channel (plus marker) PPM radio link.



The separation and demodulation of the pulse train is usually accomplished in one operation at the receiver through the use of "time gating circuits." These circuits are analogous to selective frequency band pass filters—used in frequency division systems—in that they are selective over a particular time band during which the individual channel pulse occurs.

A simple "time gating circuit" is the Cyclophon channel separator and demodulator shown in Fig. 11. In this circuit the electron beam is caused to rotate around the anode targets through the application of sinusoidal voltages across both the horizontal and vertical deflection plates. Both voltages are derived from the same source—but one is shifted 90° out of phase to give a circular Lissajous figure. The frequency and phase of the voltage is synchronized to that of the marker pulse. The mechanical arrangement of the anode targets or collectors is such that the beam will strike anode 1 when the channel 1 pulse is applied to control grid, anode 2 during channel 2, and so on for each channel.

The pulse train is applied to the control grid of the Cyclophon, which is biased to cutoff in the absence of the pulses. The presence of the pulses, however, keys on the beam, permitting it to strike the appropriate target. In a PAM system, the magnitude of the pulse determines the intensity of the beam, and consequently the magnitude of the current collected at the individual channel anodes. The voice signal may then be extracted by passing the modulated pulses through a low pass filter whose cutoff is between the highest required voice frequency and the pulse repetition rate.

It is possible to use the same type of circuit for the demodulation of PPM trains. In this case, the Cyclophon anode apertures are so arranged that the beam is half way on the channel collector plate at zero pulse displacement. In this way, as shown in Fig. 17, the physical position of the beam is varied as the channel pulse is moved in time position—so that more or less current is intercepted by the collector plate. Hence an amplitude variation, proportional to the pulse position, is obtained in the collector circuit. This signal is then passed through a low pass filter and the original voice modulation is recovered.

The process of time gating may also be accomplished by using conventional vacuum tubes. In one such circuit, shown in Fig. 16, a separate tube is provided for each channel. This tube is normally cut off and conducts only during its proper channel period. The operation requires the use of an auxiliary gating pulse which drives the tube

above cutoff at the appropriate time. This pulse may be derived from a delay line commutator. In this system, the separated marker pulse is fed to the delay line which has a number of taps—equal to the number of channels—so spaced that the proper channel timing is obtained. The output of the first tap is fed to tube 1, permitting it to conduct during the period that the first pulse in the train—corresponding to channel 1—occurs. The same procedure is followed for each succeeding channel.

In a PAM system, the gating pulse is made trapezoidal with a duration not less than the duration of the input pulse nor so large as to run into the next channel. The output of such a circuit is then amplitude modulated. In a PPM system, the gating pulse has a slanted top so that the amplitude of the output pulse is a function of the position of the input pulse as shown in Fig. 16C.

Numerous variations of these basic circuits are possible and once the principles of PAM and PPM demodulation are clearly understood, other circuits may suggest themselves.

An important factor in the design of pulse communication systems is the aforementioned scanning rate. It has been stated that this rate must be sufficiently large to allow faithful reproduction of the modulating signal and to be filtered out at the receiver. On the other hand, the lower the repetition rate, the more time there is available to use more channels, increase the time spacing between channels, or utilize wider pulses. In practice the lowest possible frequency is used that can be adequately filtered out.

It is well known that when a continuous wave carrier is amplitude modulated, side band frequency components are formed above and below the carrier frequency. If the carrier frequency is  $f_c$ , the side band components are at  $f_c - f_a$  and  $f_c + f_a$ , where  $f_a$  is the modulation frequency. Amplitude modulated pulses give a similar configuration of frequency components with the addition of the harmonics of the repetition rate—each harmonic having its set of side bands. The distribution of the frequency components of a PAM wave is shown graphically in Fig. 15.

The lowest side band in this distribution is obviously  $f_c - f_{amax}$ , where  $f_{amax}$  is the highest audio frequency to be transmitted. Therefore, in order to filter out all the components but the original signal, a low pass filter must be used whose cutoff frequency is between  $f_{amax}$  and  $f_c - f_{amax}$  (dotted line in Fig. 15). Hence, to recover the modulating signal without distortion,  $f_c$  must be at least equal to  $2f_{amax}$ . This minimum value assumes the use of an ideal filter. Practically, however, such a filter characteristic can only be ap-

Pulse scanning rate.....	8000 p.p.s.
Modulating signal band.....	300-3200 c.p.s.
Marker pulse type.....	double pulse
Marker pulse spacing.....	1.3 microseconds
Channel pulse spacing.....	5 microseconds
Pulse width.....	0.5 microseconds
Pulse buildup time.....	0.15 microseconds
Pulse decay time.....	0.2 microseconds
Full modulation displacement.....	$\pm 1$ microseconds
Signal level for full modulation.....	-20 db in 600 ohms
Demodulator output for full modulation.....	+4 db in 600 ohms

Table I. Characteristics of a pulse communication system built by FTL.

proached. The ratio of  $f_c$  to  $f_a$  used will consequently be determined by the filter cutoff characteristic and the allowable distortion.

For PPM a similar condition exists. In this case, the frequency component  $f_a$  is absent but the pulse carrier frequencies contain a number of upper and lower side bands. For example, around  $f_c$  there are components at frequencies  $f_c \pm nf_a$ , where  $n$  is any integer. For this reason there is no theoretical value of  $f_c$  that will allow perfect reproduction of the modulating signal. In practice it has been found that when a ratio of 2.5 is used with a sharp filter cutoff characteristic distortions as low as 1% may be obtained. Fig. 20 shows the measured distortion versus  $f_c/f_{amax}$  obtained using a sharp filter cutoff.

Once the scanning rate has been determined for a particular pulse system, the number of channels and pulse char-

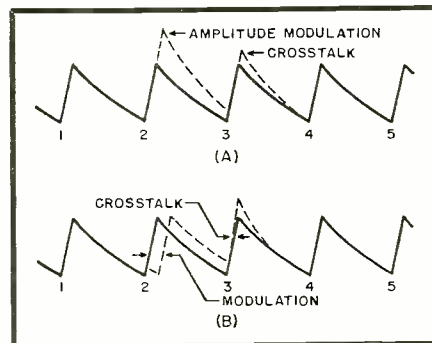

Fig. 19. Crosstalk developed in PAM (A) and PPM (B) because of poor high frequency response.

acteristics can be derived by a consideration of the amount of interchannel crosstalk that may be tolerated. For telephone service requirements crosstalk must usually be kept at least 60 decibels below full channel output. This

# The Shape and Size YOU need!

## PARAMOUNT SPIRAL WOUND PAPER TUBES

**All Sizes in Square and Rectangular Tubes**

Leading manufacturers rely on the quality and exactness of PARAMOUNT paper tubes for coil forms and other uses. Here you have the advantage of long, specialized experience in producing the exact shapes and sizes for a great many applications. *Hi-Dielectric, Hi-Strength.* Kraft, Fish Paper, Red Rope, or any combination. Wound on automatic machines. Tolerances plus or minus .002". Made to your specifications or engineered for YOU.

**PARAMOUNT PAPER TUBE CORP.**  
 613 LAFAYETTE ST., FORT WAYNE 2, IND.  
*Manufacturers of Paper Tubing for the Electrical Industry*

SEND FOR ARBOR LIST OF OVER 1000 SIZES Inside Parameters from .592" to 19.0" Convenient, Helpful, Lists great variety of stock arbors and tube sizes. Includes many odd sizes. Write for Arbor List today.

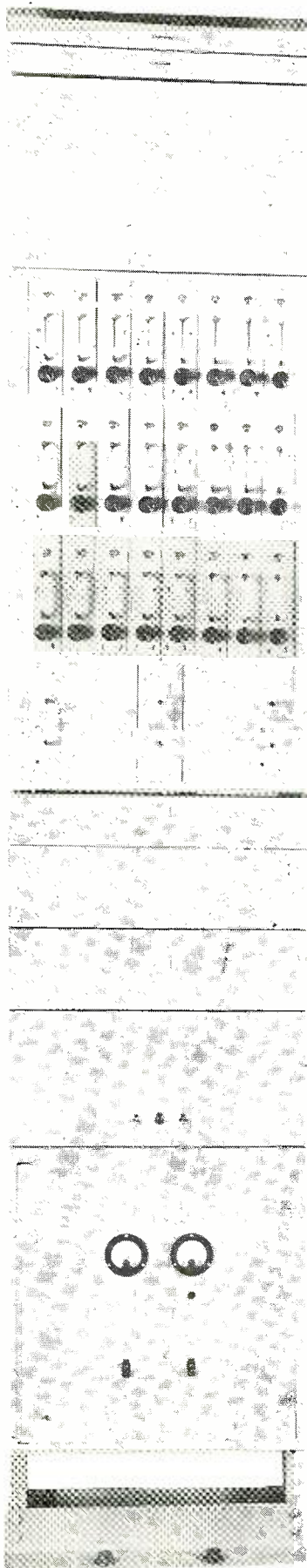

Receiving terminal of a 24 channel Pulse Position Modulation telephone system developed by FTL.

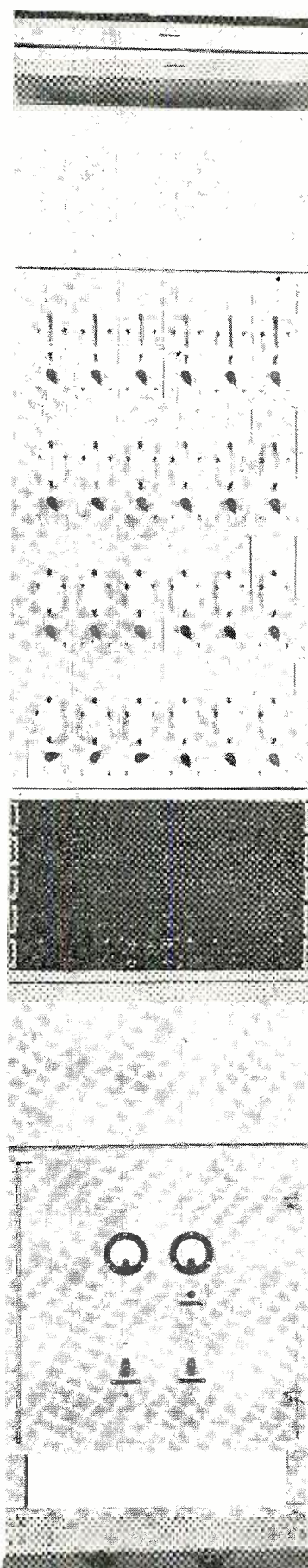

Transmitting terminal of a 24 channel Pulse Position Modulation telephone system developed by FTL.

means that the interfering signal on any channel must be less than one thousandth that of the full signal voltage on that channel.

Crosstalk between successive channels is caused mainly by inadequate high frequency response<sup>3</sup> in the pulse circuits and transmission systems. This is shown in Fig. 19A for PAM where a poor response has caused the decay of one pulse to extend into the succeeding pulse—causing the latter to increase in amplitude. The amount of energy carry-over, and hence the amount of crosstalk is, of course, dependent upon the high frequency cutoff characteristics of the circuits involved.

When using PPM the same type of crosstalk occurs but may be somewhat reduced since the amplitude variations can be eliminated by clipping and limiting. However, the poor high frequency response also varies the timing of the pulse which is reflected in the message signal when the pulse train is demodulated.

Crosstalk can be reduced by either utilizing wider bandwidth circuits or increasing the time between channels. There is a practical limit to the maximum bandwidth that can be used, since increasing the bandwidth introduces design difficulties including more noise. By determining these factors, the number of channels that can be placed in the scanning period can be derived.

A typical pulse communications system is that developed by *Federal Telecommunication Laboratories* for the simultaneous transmission of 24 telephone channels. In this system, shown in Fig. 18, delay line commutators are used in both the transmitting and receiving equipment. In order to minimize the introduction of crosstalk the pulses are modulated in groups of 8, each pulse being separated from the succeeding one by a time spacing of three channels. Thus the first unit modulates channels 1,4,7, . . . . 22; the second unit modulates channels 2,5,8, . . . . 23; and the third unit modulates 3,6,9, . . . . 24.

The modulators only perform a preliminary shaping operation and the pulses obtained are wider than those finally used. The pulses are then shaped further in groups of 8, after which the three groups are interleaved. In this way economy in quantity of tubes used is obtained.

In the receiver, the pulses are sliced and differentiated to remove all amplitude variations including noise. Again the demodulators are arranged in groups of three, this time for mechanical reasons. This equipment has the characteristics shown in Table I.

By means of such multiplex terminal equipment, radio links have been established in which 24 simultaneous tele-

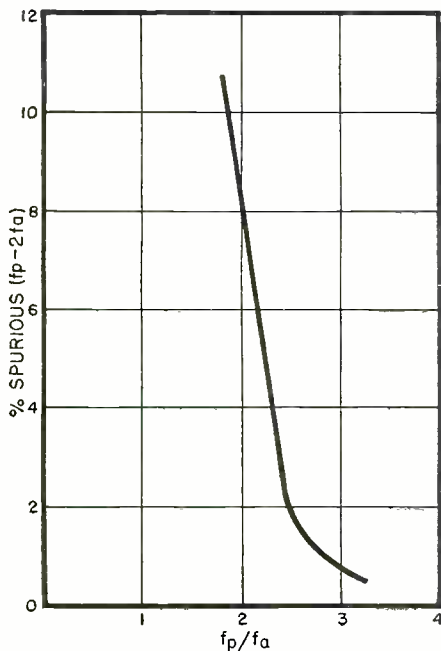

Fig. 20. Percent spurious response vs. ratio of pulse frequency to modulation frequency.

phone conversations may be transmitted. One such link has been set up between New York City, N. Y. and Trenton, N. J. This link uses two repeater stations at intermediate points. The radio frequency transmitters are amplitude keyed and operate at a frequency of 2000 megacycles with an average power of 4 watts. Highly directive antennas are used both for transmitting and receiving.

**BIBLIOGRAPHY**

1. Moskowitz and Racker, "Pulse Measurements and Instruments," RADIO-ELECTRONIC ENGINEERING, August, 1948.
2. Moskowitz and Racker, "Pulse Shaping Circuits," RADIO-ELECTRONIC ENGINEERING, March, 1948.
3. Moskowitz and Racker, "Pulse Amplifier Design," RADIO-ELECTRONIC ENGINEERING, February, 1948.
4. Moskowitz and Racker, "Pulse Techniques," RADIO-ELECTRONIC ENGINEERING, Jan., 1948.
5. Moskowitz and Racker, "Delay Lines for Pulse Applications," RADIO-ELECTRONIC ENGINEERING, April, 1948.
6. Moskowitz and Racker, "Pulse Generation," RADIO-ELECTRONIC ENGINEERING, July, 1948.
7. Roberts and Simmonds, "Multichannel Communications Systems," Wireless Engineer, vol. 22, Nov., 1945, p. 538.
8. Bennett, W. R., "Time Division Multiplex Systems," Bell System Technical Journal, vol. 20, April, 1941, p. 199.
9. Grieg, D. D., "Pulse Count Modulation," Electrical Communications, vol. 24, No. 3, Sept., 1947, p. 287.
10. Fredendall, et al., "Transmission of Sound on the Picture Carrier," Proc. IRE, vol. 34, Feb., 1946, p. 49.
11. Grieg and Levine, "Pulse Time Modulated Multiplex Radio Relay System—Terminal Equipment," Electrical Communications, vol. 24, No. 2, June, 1947, p. 159.
12. Grieg and Gallay, "Pulse Time Modulated Multiplex Radio Relay System—Radio Frequency Equipment," Electrical Communications, vol. 23, No. 2, June, 1946, p. 141.
13. Trevor, Dow, and Houghton, "Pulse Time Division Radio Relay," RCA Review, vol. 7, No. 4, Dec., 1946.
14. Deloraine and Labin, "Pulse Time Modulation," Electrical Communications, vol. 22, No. 2, 1944, p. 91.
15. Fitch, E., "The Spectrum of Modulated Pulses," Jour. of IEE, vol. 94, part IIIA, No. 13, 1947, p. 556.

16. Levy, M. M., "Some Theoretical and Practical Considerations of Pulse Modulation," Jour. of IEE, vol. 94, part IIIA, No. 13, 1947, p. 565.
17. Grieg and Moskowitz, "Pulse Time Multiplex Broadcasting in U-H-F," Proc. National Electronics Conference, vol. 2, 1946.
18. Grieg, Glauber, and Moskowitz, "The Cyclophon: A Multipurpose Electronic Commutator Tube," Proc. IRE, vol. 35, No. 11, Nov., 1947.

**Electronic Computers**

(Continued from page 5)

consider the very simple differential equation:

$$\frac{dy}{dx} = y \dots\dots\dots (3)$$

The solution of this equation is:

$$y = k e^x \dots\dots\dots (4)$$

However, digital methods cannot give the answer in this form. They give an answer as a numerical solution for any given set of initial conditions. If the initial conditions are given as  $x_0=0, y_0=1$ , the answer can then be computed as values of  $y$  for various values of  $x$ , for example, for  $x=0.01, 0.02, \dots, 0.99, 1.00$ ). In general, however, this form is the one in which the results are most useful to engineering and empirical science.

To solve a differential equation numerically, the differentials must be replaced by small finite intervals. Thus,  $dy/dx$  is replaced by  $\Delta y/\Delta x$ . This gives

$\Delta y/\Delta x = y$  or  $\Delta y = y\Delta x$  from which the increase in  $y$  can be computed from a given increase in  $x$ . If the initial values are denoted by  $x_0$  and  $y_0$ , the next values by  $x_1$  and  $y_1$ , etc., then the values of  $x_1$  and  $y_1$  are found to be:

$$\left. \begin{aligned} x_0 &= 0, y_0 = 1, \Delta x = 0.01 \\ \Delta y_0 &= y_0 \Delta x = 1(0.01) = 0.01 \\ x_1 &= x_0 + \Delta x = 0 + 0.01 = 0.01 \\ y_1 &= y_0 + \Delta y_0 = 1 + 0.01 = 1.01 \end{aligned} \right\} \dots (5)$$

In the same manner,  $x_2$  and  $y_2$  are found from  $x_1$  and  $y_1$  to be:

$$\left. \begin{aligned} \Delta y_1 &= y_1 \Delta x = 1.01(0.01) = 0.0101 \\ x_2 &= x_1 + \Delta x = 0.01 + 0.01 = 0.02 \\ y_2 &= y_1 + \Delta y_1 = y_1 + y_1 \Delta x = 1.01 + 1.01(0.01) = 1.0201 \end{aligned} \right\} \dots (6)$$

After ten steps the values obtained are  $x_{10} = 0.10, y_{10} = 1.1046$  (that is,  $e^{0.1} = 1.1046$ ); after 100 steps the values obtained are  $x_{100} = 1.00, y_{100} = 2.7183$  (that is,  $e^{1.0} = e = 2.7183$ ). This process can be represented graphically as shown in Fig. 1, and can be repeated indefinitely to give a complete table of values of  $e^x$ .

Thus all mathematical processes can be performed by means of the four simple basic arithmetic operations, and all the so-called higher mathematical functions and operations have been developed primarily as a method of avoiding excessive calculation and arithmetical computation.

(To be continued)



**STANDARDIZED READY-TO-USE METAL EQUIPMENT**

ADAPTABLE FOR EVERY REQUIREMENT

Par-Metal Equipment offers many features, including functional streamlined design, rugged construction, beautiful finish . . . plus ADAPTABILITY. Eliminate need for special made-to-order units on many jobs.

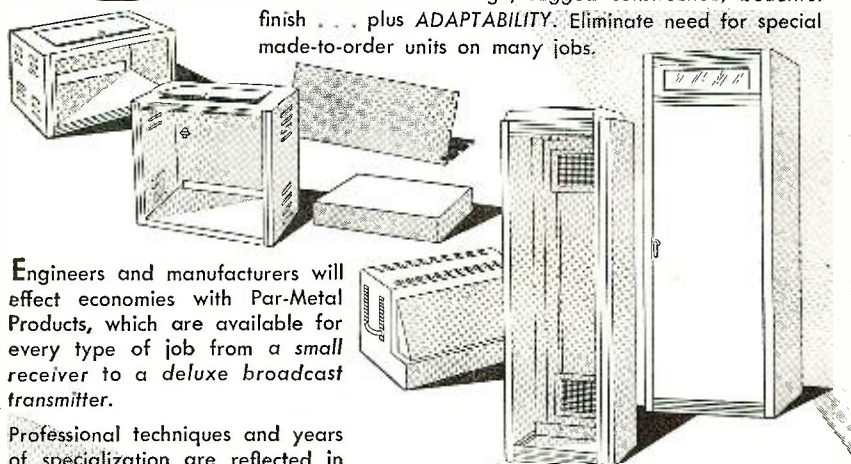

Engineers and manufacturers will effect economies with Par-Metal Products, which are available for every type of job from a small receiver to a deluxe broadcast transmitter.

Professional techniques and years of specialization are reflected in the high quality of Par-Metal. . .

**CABINETS • CHASSIS  
PANELS • RACKS**

Write for Catalog

**PAR-METAL PRODUCTS CORPORATION**  
32-62 - 49th STREET  
LONG ISLAND CITY 3, NEW YORK  
Export Dept.: Reske International Corp.  
13 East 40 Street, New York 18

# NEW PRODUCTS

## PHOTOMICRON

Within fifteen seconds the photomicro, an automatic blood counting microscope, will perform a red cell and

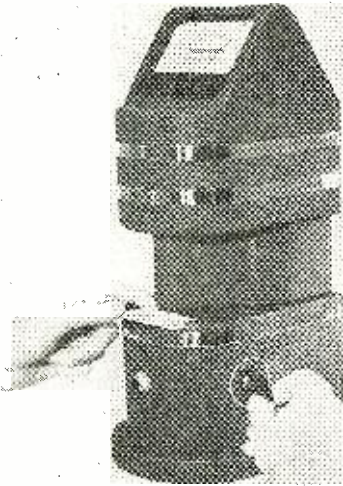

white cell count and a hemoglobin determination. This same process takes a lab technician approximately fifteen minutes. It is expected that country doctors who lack trained help, as well as busy clinics and hospitals, will find this device a tremendous expediter in their daily routine. *Rowland Research Laboratory*, 442 St. James Building, Jacksonville 2, Fla., is the manufacturer.

## ELECTRIC EYE RELAY

A photorelay for industrial use is now available through jobbers and dealers. Operating from 115 v. 60 cycles it comprises a steel chassis, photoelectric tube amplifier, relay, and sensitivity adjustment. When any kind of light enters the 1" diameter opening to the

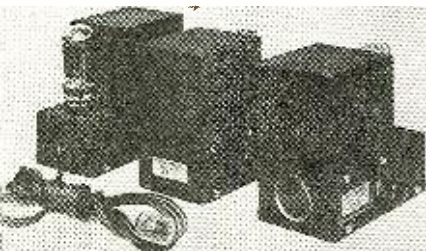

phototube, 115 v. 60 cy. is delivered. Response time is about 1/20th second. The photorelays are useful for counting small parts, controlling lighting, machinery, conveyors, detecting intruders

and substituting where a pushbutton or limit switch might be applied. *Photobell Co.*, 116 Nassau St., New York, 7, N. Y., is the manufacturer.

## LUSTRALLOY

A new material in the plated metals field which permits a uniform nickel plating to be obtained without the use of electric current has been made available by the *Lustralloy Sales Corp.*, 10 East 52nd St., New York, N. Y. It leaves a bright high quality finish that is tarnish and corrosion proof, and may be applied to any base metal. Lustralloy may be hardened to as high as VPN 900 with unusual ductility.

## CENTER TENSION DEVICE

A new tension device, for coil winding machines, that gives more precise tension control and permits winding of more coils at one time has been announced by *Associated Production Co.*, 2655 W. 19th St., Chicago 8, Ill.

This tension device has a swivel construction so spools can be mounted

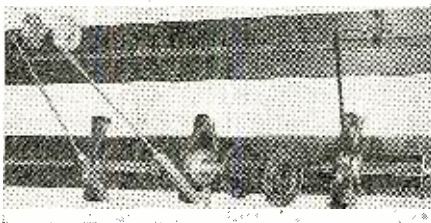

parallel with the winding arbor and closer together. There is an easily operated but positive lock for removal of spools. Accommodation is for 16 to 42 gauge wire.

## NEW SINGLE SIDEBAND SELECTOR

The Specialty Division of the *General Electric Company's Electronics Department*, Syracuse, N. Y., has developed a single sideband selector which provides improved reception in crowded amateur and communications radio bands without affecting the quality of the received signal. It features great reduction of distortion due to selective fading for long distance reception of ordinary AM signals. There are four push-buttons on the device, one for dual sideband reception with reinforced carrier, one for normal reception and one for selection of each sideband. It is designed for use with any receiver having

an intermediate frequency of approximately four hundred and fifty-five kc.

## PAC TIMERS

A new series of PAC timers is now available from *Industrial Timer Corp.*, 115 Edison Place, Newark, N. J. They

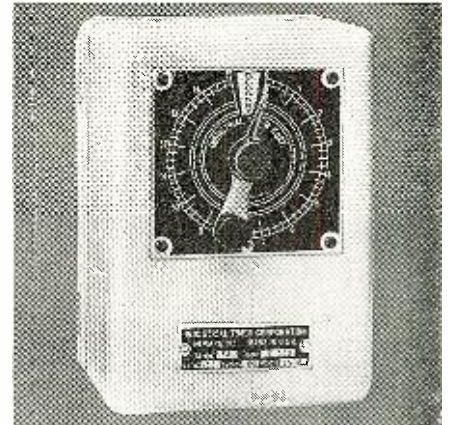

are specifically designed for process control in industrial applications where long life and trouble-free operation is a requirement. They feature an instant automatic reset. As soon as the clutch is disengaged, an internal spiral spring brings the actuating arm back to its reset position in a fraction of a second. There is also a time setting adjustment, a button pointer to the time cycle required. For more details, request Bulletin No. 58.

## QUINTERRA

A new high temperature insulation developed by *Johns-Manville* is a tissue thin asbestos product. Only 2 mils thick, it will neither ignite, melt nor char under the flame from an electrician's alcohol torch, shown in this picture. Resembling paper in appearance, it is furnished in long lengths in roll or tape form. In addition to its non-combustible properties, quinterra possesses a high dielectric strength of well

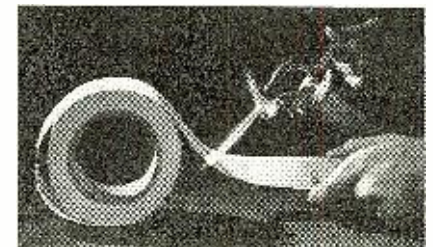

over 250 VPM, even at elevated temperatures, and a long thermal life.

## METROSCOPE

An ultrasonic device known as the metroscope will automatically measure the wall thickness of metal, plastic or glass parts where only one surface is accessible and also makes rapid, non-destructive tests to detect flaws and imperfections in these materials. In testing for flaws it can reveal thin voids



and cracks that do not appear in an x-ray.

The metroscope employs an electronic oscillator to generate electrical voltage,



the frequency of which is varied throughout the tuning range of the oscillator. The point or points in this tuning range at which the part resonates are indicated. Further information is available from the manufacturer, *Photocon Research Products*, 1062 N. Allen Ave., Pasadena 7, Calif.

#### PRECISION FREQUENCY COUNTER

Utilizing high speed electronic counters, the *Potter Instrument Co.*, 136-56 Roosevelt Ave., Flushing, N. Y. provides a simple means of measuring frequencies with accuracies of one part in ten million or greater. This can be done without calibrating, tuning, zero beating or interpolating. The unit con-

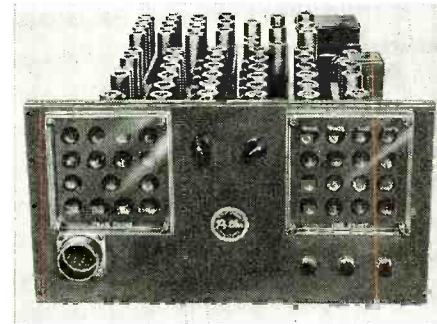

sists of two high speed electronic counters, a crystal oscillator and an electronic switch.

#### ELECTRONIC COMPUTER

A new high-speed general purpose electronic computer is being marketed by the *Eckert-Mauchly Computer Corporation*, Broad and Spring Garden Streets, Philadelphia 23, Pennsylvania. The computer, termed the UNIVAC, is the first small machine to work directly

in the decimal number system which can handle letters and punctuation marks.

It uses a metal ribbon, for magnetic recording, which can be placed in an automatic printing machine. The machine is also designed to classify, arrange, and sort information in a wholesale fashion and there is no limit upon the number, sequence of operations or complexity of instructions which it can perform.

#### TELEQUIP

A combination sync generator, monoscope, picture generator, and distribution panel has been developed for production line testing of television equipment and for transmitting stations. It is available in a combination unit or separately.

The equipment produces synchronizing, driving, and blanking signals and cuts the time required for testing considerably. Two monographs describing the details, explaining the theory of operation and giving instructions for its use and maintenance may be had upon request to *Telequip Radio Co.*, 1901 S. Washtenaw Ave., Chicago 8, Ill.

#### MASTER VOLTOHMYST

Capacity measurements over an extremely wide range are possible with

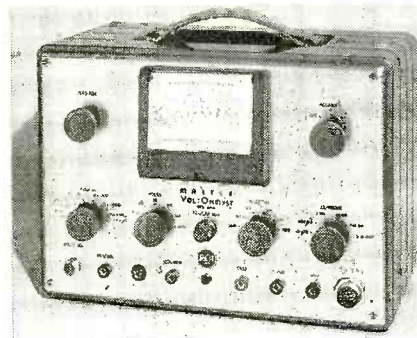

*RCA's* new electronic voltmeter. A "miniature electronics laboratory," it combines the functions of eight meters in the one compact, portable unit, and is intended especially for handling the large number of capacity measurements encountered in the servicing of high-frequency equipment. Among the outstanding design features is a special electronic bridge circuit which makes the meter virtually burnout-proof. Write Camden, N. J., for other details.

#### HEAT TRANSFER UNIT

A heavy duty heat transfer unit for cooling the magnetron power tube in an induction-heated oven or the tubes and condensers in television transmitters, short wave communications sets, radar sets and general laboratory use has been announced by *Eastern Industries Inc.*, 296 Elm, New Haven, Conn.

(Continued on page 31)

## Laboratory Standards

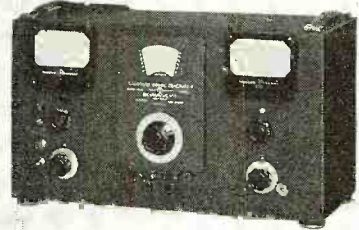

#### STANDARD SIGNAL GENERATOR

Frequency range: 75 kc. to 30 mc. Output 0.1 microvolt to 2.2 volts. MODEL 65B

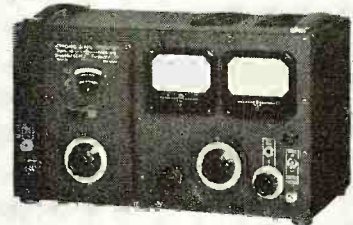

#### STANDARD SIGNAL GENERATOR

Frequency range: 2 mc. to 400 mc. Output 0.1 microvolt to 0.1 volt. MODEL 80

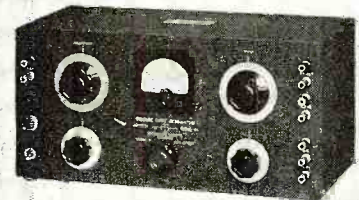

#### SQUARE WAVE GENERATOR

5 to 100,000 cycles. Recommended for AM, FM and television testing. MODEL 71

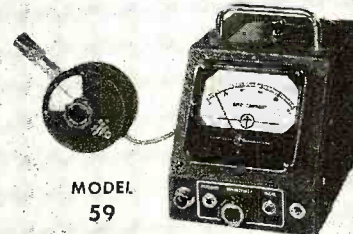

MODEL 59

#### MEGACYCLE METER

A versatile grid-dip oscillator covering the frequency range of 2.2 mc. to 400 mc.

MANUFACTURERS OF:  
Standard Signal Generators  
Pulse Generators  
FM Signal Generators  
Square Wave Generators  
Vacuum Tube Voltmeters  
UHF Radio Noise & Field Strength Meters  
Capacity Bridges  
Megohm Meters  
Phase Sequence Indicators  
Television and FM Test Equipment

CIRCULARS ON REQUEST

MEASUREMENTS CORPORATION

BOONTON NEW JERSEY

# Capacity Tuned TELEVISION TUNER

By

**J. A. STEWART**

General Instrument Corp.

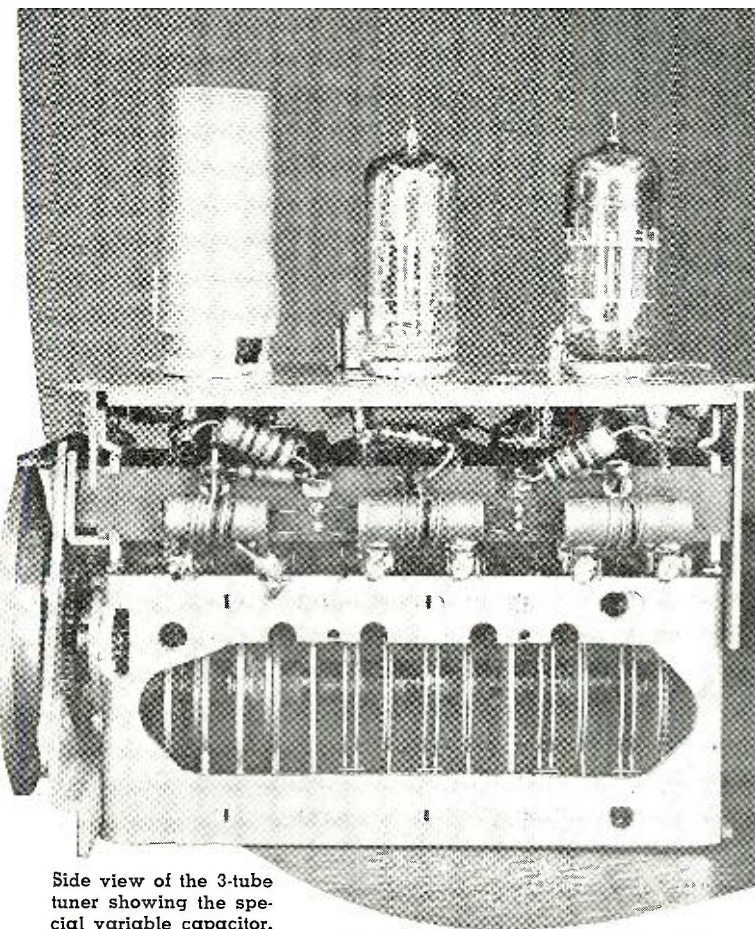
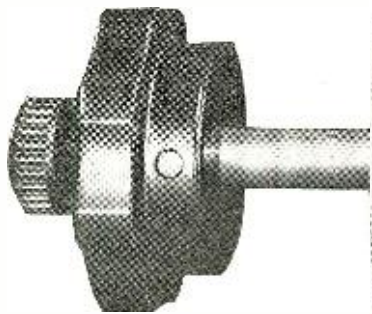

Side view of the 3-tube tuner showing the special variable capacitor.

**History and development of a television tuner using specially shaped capacitor plates for tuning to various channels.**

**T**HIS paper presents an historical review of a design development that resulted in a practical capacity-tuned television head. This, you might very well say, is heresy. Why use capacity, the black sheep of the *L-C* family? To be perfectly frank, it was with much trepidation that we approached this problem. However, we at *General Instrument* felt that with our experience during the war tuning medium and high frequency circuits with capacitors, and with our experience as mass producers of variable condensers, we could present the television industry with something it needs very badly, a low-cost television tuner.

Let us now examine the components of such a tuner and see where our major problems lie. We need a variable frequency oscillator which should be tuned over the required range of frequency with a high capacity. Then we add a converter, whose performance is not a function of capacity if we consider its operation by looking into the mixer grid. And finally we need a tuned radio frequency amplifier, whose performance is not only a function of capacity but an adverse function of capacity.

At this point the normal thing to do is build a switch-type tuner. But we did not do the normal thing. Instead we proceeded with a more detailed analysis of the problem to see how serious are the effects of capacity and just what

compensating factors, if any, enter into the over-all picture.

Examining in detail the various defects in the superhetrodyne receiver, we may analyze the part capacity tuned circuits will play in increasing or decreasing these defects.

First, signal to noise ratio. This is primarily a function of the input circuit and first tube and does not constitute any problem in this unit. Next are those items which are a function of the number of tuned circuits used; namely, i.f. rejection, image rejection, second harmonic of the oscillator image rejection, and oscillator radiation. The suppression of these frequencies is a function of *Q* for a single tuned circuit, and a function of coupling for a double tuned band pass circuit. Since the band pass circuit has the better selectivity characteristic, and since its effectiveness does not vary with *Q*, we shall continue the analysis on the basis of this type circuit.

And now we come to those functions that must be supplied by the 'front end', gain and bandwidth. An expression for the maximum theoretical gain of a single double tuned stage of amplification is:

$$A \approx \frac{g_m}{4\pi C \Delta f} \dots \dots \dots (1)$$

where *C* is the total shunt capacity

Excerpts from a paper presented at the IRE Television Conference at Cincinnati on April 24, 1948.

across one coil, and  $\Delta f$ , the bandwidth between peaks, is expressed by:

$$\Delta f = F_r k \dots \dots \dots (2)$$

where *k* is the coupling between the two circuits, and *F<sub>r</sub>* is the resonant frequency of the tuned circuits.

To obtain exact solutions for exact expressions for all the pertinent frequencies is beyond the scope of this paper, but we shall use them in a qualitative analysis of the theoretical gain and bandwidth variations with capacity. From these expressions it is immediately evident that the gain and bandwidth will be maximum at the highest frequency, and that gain, bandwidth and frequency will decrease with an increase in capacity. An examination of the capacity ratios required to tune the television frequency range will be a first approximation of the losses that might be encountered. Since:

$$\omega^2 = 1 / LC \dots \dots \dots (3)$$

a frequency change of 54 to 216 megacycles would require a capacity ratio of 16:1. This is not practical. If we use two distinct *L-C* circuits, one for each band, we have: for the low band (dropping channel #1) 54 to 88 mc., a capacity ratio of 2.7 to 1; and for the high band, 174 to 216 mc., a capacity ratio of 1.54 to 1.

Returning to the expressions for gain and bandwidth [Eqts. (1) and (2)], it may be shown that the gain and band-

width variations with capacity will each be approximately 1.6 to 1. This is still not good enough; but by allowing the coupling to vary with frequency along with normal  $Q$  variations, we obtain enough compensation to produce a gain change of 1.5 to 1, and a bandwidth change of but 1.3 to 1. These ratios were obtained by measurement. Applying the same reasoning to the high band, we obtain still better ratios. On the basis of this type of analysis, we felt that a capacity tuned tuner was far from impractical. Even if we should be forced to lose some of the maximum theoretical gain, it would not be too serious if a good signal to noise ratio is obtained.

The circuit of our tuner is completely conventional, and because it is conventional, and because of its performance, we feel it to be a good circuit. In the course of its design, many stunts and tricks were tried. To quote a few, lumped capacity loading, regenerative networks, and simulated resonant lines were all played with. One would give excellent gain at the high end of one band and nothing on the low. Another would do just the opposite. Combinations just wouldn't work at all. In every case we returned to a standard parallel tuned resonance circuit.

We chose our input untuned. We feel that not enough data on the allowable mismatch to the antenna is available at present to justify a tuned input. The r.f. amplifier is a double tuned push pull stage using the 6J6 twin triode. Push pull operation has several advantages. Higher gain, improved selectivity, and more stable operation with a grounded rotor condenser is realized. In addition, the signal to noise ratio of a triode is about three times better than that of a pentode.

Coupling between the two tuned circuits was one of the most difficult problems since it was necessary that changes in coupling with tuning offset the change in bandwidth with capacity. Various combinations of capacitive and inductive coupling were tried. The solution proved to be link coupling with only stray capacity coupling due to coil placement. With this type of coupling, the proper adjustment is simplified. We have but two adjustments necessary for proper r.f. alignment of all the channels. The inductances are pre-aligned before assembly, and the coupling is set by link adjustment on each band.

The converter is again a 6J6 with the grids in push-pull, and the plates tied together with either a single or double tuned i.f. coil for its load impedance. Oscillator injection voltage is supplied by another link, and bias for the converter is developed by this voltage. It was found impractical to maintain a constant conversion gain throughout the

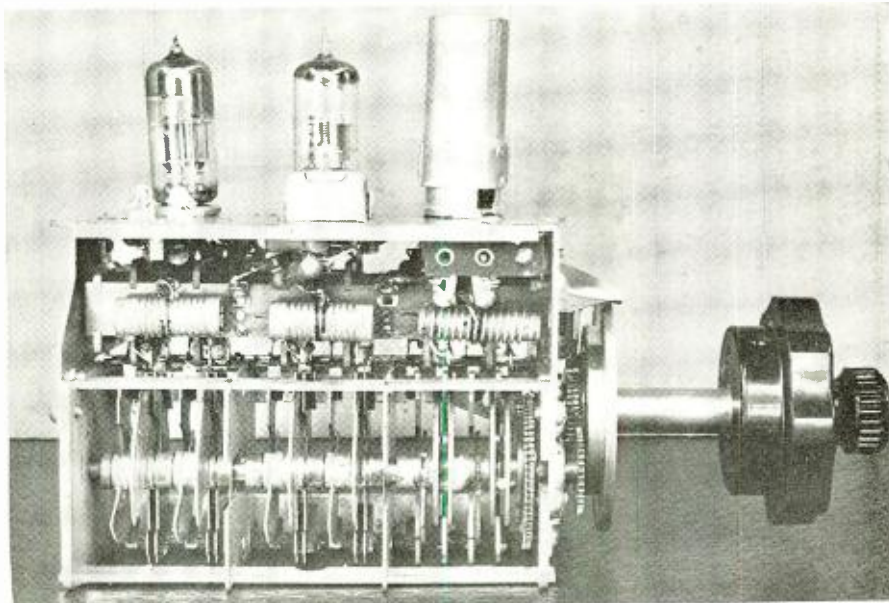

Left side of unit illustrates tube mounting, i.f. output coil, and antenna terminals.

entire band. This difficulty was utilized to compensate for gain changes in the r.f. amplifier, providing an over-all gain that is substantially constant for all channels.

The oscillator design was straight forward. One half of a 6J6 is used in a modified Hartley. Good output is easily obtained on both bands. A single slug-tuned inductance supplies the tracking adjustment.

Since this tuner was built around a variable condenser, both electrically and mechanically, we have chosen to discuss this condenser separately. We have shown that it must be two separate condensers with three push-pull sections ganged on a ground shaft. Each section is quite standard with 180° rotation from maximum to minimum. The rotor sections of both condensers are mounted on a common shaft with the plates of one section shifted 180° with respect to the other. Thus we have an effective 360° rotation with a single knob for tuning, compressed into one compact unit.

The plate shape of the condenser was designed for modified straight line frequency to give good channel distribution. A detent mechanism on the shaft permits switch type channel selection, and a concentric shaft vernier drive permits fine tuning adjustment. Mechanical push buttons may be used in place of the detent, should that type of channel selection be desired. The switching from one band to the other is done automatically with a simple cam arrangement. This switching is a necessary evil, since switch contacts at television frequencies have given trouble in many instances; but since our switch is used only in moving from one band to another, its life expectancy is much greater than that of a usual type tuner. Experience with variable condensers has shown them to outlast almost any other component in a receiver.

It has been indicated that this tuner's performance is more than adequate. In presenting a paper such as this before  
(Continued on page 27)

Now! Specify **KENYON**



For all high quality sound applications, for small transmitters, broadcast units, radar equipment, amplifiers and power supplies — Specify KENYON! Inquire today for information about our JAN approved transformers.

Now — for the first time in any transformer catalog, KENYON'S new modified edition tells the full complete story about specific ratings on all transformers. Our standard line saves you time and expense. Send for the latest edition of our catalog now!



**KENYON TRANSFORMER CO., Inc.** 840 BARRY STREET  
NEW YORK 59, N. Y.

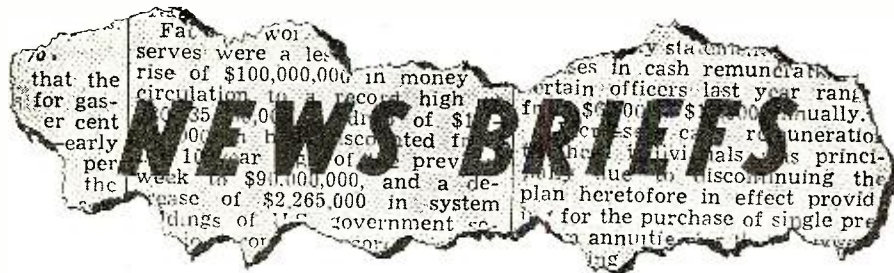

**EICO MOVES**

Rapid growth of business volume necessitated the removal of the *Electronic Instrument Company* to 377 Blake Avenue, Brooklyn 12, N. Y. Accompanying the change is a substantial increase in plant equipment and personnel. In particular their greatest effort is now bent towards making an all-electronic vacuum tube voltmeter, essential to the critical servicing standards of FM and television.

**ARMSTRONG MEDAL AWARD**

Describing the late Stuart Ballantine as one of the world's most versatile engineers, Major Edwin H. Armstrong presented the Armstrong Medal to Mrs. Stuart Ballantine recently. The medal was awarded to Mr. Ballantine for outstanding contributions in the art. Among these were his development of



the loop compass and radio direction finder, negative feedback as well as automatic volume control, the theory of the vertical antenna and its low angle radiation, and work in acoustics.

**NAB OFFERS AID TO FCC**

Full cooperation of the broadcasting industry with the Federal Communications Commission in solving problems concerning "frequency spectrum requirements, allocations, and engineering standards" was recently extended in a telegram to the chairman of FCC from a committee of the National Association of Broadcasters. In addition NAB offered to "aid the commission in any experimental or developmental work within their scope." To insure broadest representation of all industry segments, the committee for NAB will include Technical Advisory Members as well

as Network Advisory Members and NAB Board Liaison Members.

**AUDIO SOCIETY FOR SAN FRANCISCO**

The initial organizing meeting leading toward formation of a San Francisco section of the Audio Engineering Society was held recently. Attended by about thirty Bay Area audio specialists of various types, the meeting established a temporary chairman and heard a talk and demonstration of the *Ampex* tape recorder, presented by Myron Stolaroff of that company. Mr. Stolaroff described the new recorder, discussed features of some specific installations, and performed an A-B test demonstration of the machine. A second meeting is scheduled for the near future.

**NEW SYLVANIA LAB**

The cornerstone for the first of a group of modern research laboratories for Sylvania Center was laid recently by Walter E. Poor, chairman of the board of *Sylvania Electric Products, Inc.* This type of campus research will be the first of its kind to be built in New York City. The initial laboratory building, which with equipment will represent an investment of approximately a million dollars, will be one of a group of laboratories which will comprise a group covering 28½ acres.

**LEVY MEDAL PRESENTED**

The 1948 Levy Medal of The Franklin Institute will be awarded to Dr. Jan A. Rajchman (left) and Mr. William H. Cherry, according to an announcement by Dr. Henry B. Allen, executive vice-president and secretary. It is given in recognition of their paper "The Electron Mechanics of Induction Acceleration" which appeared in the April and May 1947 issues of the *Journal of The Franklin Institute*.



Dr. Rajchman has been chiefly responsible for the development of the electron multiplier and is working now in the field of electronic computing de-

vices. At present he is a research physicist for *RCA Laboratories* in Princeton. Mr. Cherry is working in the *RCA* television group and carrying on graduate studies in physics at Princeton University.

**PLANAR TRIODE**

A planar triode plate and grid and cathode sections are sealed together on a glass lathe in pilot plant production. An operator in the Advanced Development Laboratories of *Sylvania Electric Products, Inc.*, Kew Gardens, N. Y., is illustrated here, holding the tube showing concentric cathode terminals. The



tube, measuring only two inches overall is then ready for exhaust and sealing.

**BENTLEY APPOINTED**

The appointment of Charles W. Bentley as assistant to the manager of the *General Electric Company's* new plastics molding plant in Decatur, Ill. was recently announced. Mr. Bentley, a member of the Society of Plastics Engineers, was formerly employed by *Firestone Rubber and Latex Products* and *Pro-Phy-Lac-Tic Brush Co.*

**AIEE OFFICERS FOR 1948-49**

The new officers of AIEE for the next administrative year were recently announced at the annual meeting of the Institute held in Mexico City. Everett S. Lee, engineer of *General Electric Company* was elected president. Vice presidents are Victor Siegfried, John L. Callahan, Ira A. Terry, George N. Pingree and Richard McKay; directors are Clarence W. Fick, Morris D. Hooven, and F. O. McMillan; treasurer is W. I. Slichter. These officers, together with a number of hold-over officers will constitute the board of directors for the following year.

The annual report, given at this same meeting, showed a membership as of April 30, 1948, of 28,400. The total number of meetings, excluding general and district meetings, was 2,512, held by sections and student branches.

**GE PROMOTIONS**

Mr. Henry V. Erben has been elected a vice president by the board of directors of the *General Electric Co.*, and is also now in charge of the Apparatus Department in the capa-

city of general manager. He succeeds Roy C. Muir, company vice-president, who is retiring after more than 42 years with G.E.

John D. Lockton, formerly assistant treasurer, has been elected to the office of treasurer. He replaces Jesse W. Lewis who leaves G.E. after 31 years of employment.

#### FIELD ENGINEER FOR SHALLCROSS

John C. Van Groos of Los Angeles, California, has been appointed field engineer for the *Shallcross Company* of Collingdale, Pa. He will cover the territory including California, Nevada, and Arizona. Mr. Van Groos has formerly been engaged as a broadcast engineer and sales engineer. During World War II he spent over four years in the Navy, much of it in the Electronic Engineering Section, Bureau of Ships, Washington, D. C.

#### NEW LITERATURE

##### *Polyethylene Resins*

*Bakelite Corporation*, 300 Madison Ave., New York 17, N. Y., has published a compilation of the properties, methods of handling, and uses of a new low molecular weight resin designated as resin DYLT. This polymer is being offered to the wire and cable industry as a wax additive that achieves many desirable properties, as a hot melt sealing compound and as a conductor coating. A summary of compatibility possibilities is included.

##### *Flexible Wave Guides*

The *Technicraft Laboratories*, 237 East Aurora St., Waterbury, Conn., have brought out a bulletin describing their flexible wave guides and wave guide assemblies and offering their engineering know-how and services on manufacturing and consultation. Information on any of these subjects may be secured by writing the company.

##### *Sperry Reflectoscope*

The operation and application of the new portable, lightweight supersonic reflectoscope is described in a publication of *Sperry Products, Inc.*, 1505 Willow Ave., Hoboken, N. J. The information on this device, Type SRO5 may be obtained by addressing the firm and requesting Bulletin No. 3001.

##### *Lustron and Lustrex*

To provide the most up-to-date information on producing articles by the method of machining from bar or sheet stock, *Monsanto Chemical Company's* Plastics Division has issued a new handbook, "Machining and Finishing Lustron and Lustrex." This method has been warranted when the number of pieces needed is small, or when the cost per piece of a polystyrene plastic article

prohibits the use of an expensive mold.

In addition, the booklet contains specific recommendations for machining operations necessary after injection molding. Such operations are sometimes required in order to mill slots or keyways, cut grooves, tap, thread, split, saw or remove gates.

In order to procure this booklet, address that firm at Springfield, Massachusetts, requesting a copy of bulletin No. 52.

##### *New G. E. Literature*

A thirty page illustrated bulletin (No. CDR-57) describing in detail G.E. silicone products has been issued by *General Electric Company's* Resin and Insulation Materials Division. The booklet covers silicone resins, oils, greases, water repellents, and rubber together with their many industrial uses. Charts and tables are included for handy reference.

G.E. cast and sintered Alnico, Cunife, Cunico, Vectolite, Silmanal and various permanent magnet holding assemblies are discussed in a bulletin from the Metallurgy Division. Special alloys such as thermistors and Hevimet are also covered.

The Plastics Division of G.E. has put out a pamphlet devoted to the description of the design, moldmaking and molding facilities of *G. E. Plastics Division*, and discusses sealing caps and sleeves, mycalex, silicone rubber and high frequency insulation. High and low pressure laminates are summarized along with silent gears, bearings, decorative surfaces translucent sheets and name plate materials. Property tables are included.

An eighteen page illustrated booklet, describing briefly the wide range of products manufactured by the Chemical Department has just been issued. Products of the Plastics Division, Resin and Insulation Materials Division, Metallurgy Division and Compound Divi-

sion are covered, together with their many uses. Copies of all these bulletins listed here may be had by writing to the Chemical Department, *General Electric Co.*, Pittsfield, Mass.

## Television Tuner

(Continued from page 25)

an assembly of engineers, measurement figures should be all that is necessary to evaluate the unit. But that is not the case. Each of us has his own methods and standards.

In view of this situation we are forced to present comparison measurements as the only way to measure performance. For these primary functions: signal to noise ratio; bandwidth; gain; image rejection; i.f. rejection; second harmonic oscillator image rejection; oscillator radiation; oscillator stability; comparison measurements revealed the performance of this tuner to be equal or better than that of a nationally-known and thoroughly field-tested tuner.

To sum up we are quite pleased to announce that we have exonerated that black sheep, capacity, and are able to present to you today a capacity tuned television tuner. A tuner that is practical, flexible, and easily produced. A tuner that is small, that has good performance and that is, above all, inexpensive.

## New! FORMICA YN-25 ELECTRICAL INSULATION

### 200 Times Better Insulation Resistance

The specifications for Formica "YN-25" tell their own amazing story far better than adjectives. Note particularly that impact strength is 10 times greater... insulation resistance 200 times higher than standard electrical grades of laminated insulation.

PROPERTY	VALUE
Power Factor @ 1 megacycle.....	.014
Dielectric Constant @ 1 megacycle.....	3.9
Insulation Resistance after 96 hrs. @ 95% R.H. @ 90° F.....	Over 50,000 megohms
Impact strength Flatwise.....	10 ft. lbs. per inch of notch
Edgewise.....	6 ft. lbs. per inch of notch

Write for full engineering data to Formica, 4641 Spring Grove Avenue, Cincinnati 32, Ohio.

Excellent machining, punching and post-forming characteristics mean limitless variety of possible sizes and shapes.

Productive  
**FORMICA**  
at Work in Industry

FORMICA "YN-25" - 200 TIMES BETTER INSULATION RESISTANCE

# Frequency Stability

(Continued from page 11)

$R_p$ , a decrease in either will produce a decrease in the oscillation frequency.

Likewise with Eq. (4) it is possible to show that the frequency of the Colpitts oscillator is always higher than the resonant frequency of the tank circuit and since the frequency difference is inversely proportional to the tube resistance  $R_p$  and  $R_g$ , a decrease in either will cause an increase in the oscillation frequency.

The final circuit arrangement used for the purpose of combining these effects is shown in Fig. 10 and fundamentally consists of a combined Hartley and Colpitts circuit with the adjustable resistances  $R_1$  and  $R_2$  connected to the midpoint of the tank condenser and inductance. When  $R_1$  is infinite and  $R_2$  is zero, the arrangement is equivalent to a Hartley oscillator, and when  $R_1$  is zero and  $R_2$  is infinite it is then equivalent to a Colpitts circuit. A graph of the change in frequency with a change in plate or filament voltage is shown in Figs. 12 and 13 for both extreme conditions. By means of adjusting the tap or contact to  $R_1$  and  $R_2$ , it is possible to obtain a very stabilized condition. In this particular setup, the maximum frequency stability was obtained when  $R_1$  equalled 1000 ohms and  $R_2$  equalled 600 ohms. With this setting of the tap, the frequency variation is approximately the average between the characteristics of the Hartley and Colpitts circuits.

The frequency stability of this circuit was about 35 cycles per megacycle for considerable variations of the supply voltages. Although this was accomplished primarily by empirical methods, the results are very gratifying and provide an excellent method of obtaining good frequency stability with large power output.

In addition to the frequency variations associated with the cause already mentioned, the application of a power oscillator to high-frequency heating introduces further possibilities of frequency instability.

If the load applied to a power oscillator varies, the methods of frequency stabilization already discussed in this article would tend to reduce the frequency variations.

Such variations in the load are very well illustrated by a graph originally plotted by G. Babot and M. Losinsky in their article entitled, "Heat Treatment of Steel by High-Frequency Currents" and shown in Fig. 14. In this graph, the power absorbed by a piece of steel from a high-frequency oscillator is plotted along the ordinate and the time in seconds along the abscissa. The variation in power clearly shows

that the effective resistance of the load is not constant. This type of load will definitely cause frequency variations which must be taken into consideration when designing power oscillators for such applications.

It is of interest to apply the foregoing method of frequency stabilization to an entirely different type of vacuum tube oscillator, namely, the dynatron. Assuming the simple linear theory of operation, the frequency is found to be:

$$f = \frac{1}{2\pi} \sqrt{\frac{1}{LC} \left( 1 - \frac{CR^2}{L} \right)} \dots (15)$$

This frequency does not satisfy Eq. (6) and therefore cannot be expected to be the most stable frequency of oscillation for the dynatron. Theoretically, the frequency as expressed by Eq. (15) can be altered to a value which will satisfy Eq. (6) and as a result produce a more stable oscillator. This can be accomplished by connecting an impedance in series with the negative resistance generator so that the total impedance of the generator is  $Z_g$  with a reactive component at the new oscillator frequency  $f_0$  equal in magni-

have been made to determine the effectiveness of this method of frequency stabilization. Using a pentagrid converter (6SA7) at a frequency of 450 kc., it was found that for a 10 per-cent variation of the heater current a variation of frequency could be reduced from 1200 cycles per megacycle to about 100 cycles per megacycle by connecting an inductance equal to a quarter of that in the oscillation circuit. Although an appreciable quantitative discrepancy has been observed in the numerical value of this stabilizing inductance, the advantage and utility of this method of frequency stabilization has been demonstrated by the above data.

Another method of improving the frequency stability of a dynatron oscillator was attempted by inserting a resistance in the capacitive branch of the tank circuit. The impedance of the tank circuit under these conditions, with the added resistance equal to that which is in the inductive branch, is:

$$\frac{1}{Z_L} = \frac{1}{R + j\omega_0 L} + \frac{1}{R + \frac{1}{j\omega_0 C}} \dots (20)$$

$$\frac{1}{Z_L} = \frac{2R}{R^2 + \omega_0^2 L^2} \dots (21)$$

or

$$Z_L = \frac{R^2 + \omega_0^2 L^2}{2R} \dots (22)$$

The impedance has been reduced to a pure resistance and when driven by a pure negative resistance should give an oscillation frequency equal to the resonant frequency of the tank circuit. An improvement of frequency stability of about 10 to 1 has been obtained by using this method of compensation. It is quite obvious that with this method of stabilizing the frequency a very inefficient oscillator is produced and therefore should not be used where power output is of importance.

Another method of stabilizing the frequency of an oscillator makes use of the properties of the quarter-wave line. The short-circuited coaxial line, one-quarter wavelength long, is equivalent to a parallel-resonant circuit since electric and magnetic energy may be

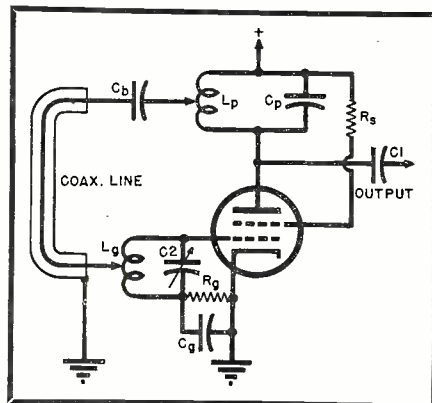

Fig. 15. Frequency stabilized oscillator using coax line as tuned coupling circuit.

tude and opposite in sign to that of the load impedance  $Z_L$ . In order to satisfy this condition at  $f_0$  it is necessary that:

$$-\frac{1}{Z_g} = \frac{1}{R + j\omega_0 L} + j\omega_0 C \dots (16)$$

and with

$$Z_g = -R_g + j X_g = -\frac{\omega_0^2 L^2}{R} + j\omega_0 L \dots (17)$$

then

$$\frac{\omega_0^2 L^2}{R} = \frac{L}{RC} \dots (18)$$

and

$$X_g = \omega_0 L \dots (19)$$

Then the frequency of resonance should be obtained by introducing an inductance equal numerically to  $L$  in series with the negative resistance of the oscillator tube.

Experimental checks upon this result

Fig. 16. Half-wave concentric line used for stabilizing the frequency of a push pull oscillator.

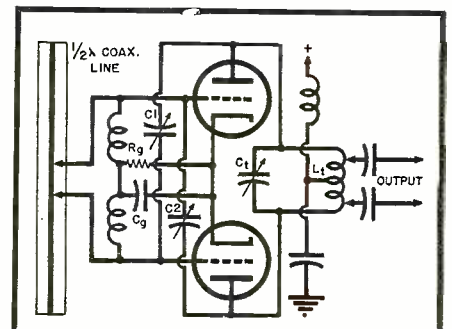

# Industrial Review



easily stored with the equivalent impedance as a high resistance. With a suitable design of the dielectric and the diameter ratio of the coaxial conductors, a quarter-wave line may be selected and mounted so that its unloaded  $Q$  is several thousand. A method of measuring the properties and electrical length of a coaxial line is shown in Fig. 1. These measurements show that the  $Q$  of the line is very high and that the line is resonant at a sequence of harmonic frequencies. It is these facts which enable the quarter-wave line to help stabilize the frequency of oscillation. In one case the  $Q$  is high while in the other the line is not only tuned to the fundamental but also to all the harmonic frequencies.

There are two basically different methods of frequency stabilization with the aid of the quarter-wave line. The first method uses the line as a resonant circuit, the frequency controlling effect being very similar to that of the piezoelectric crystal. The second method uses the line as a coupling method between the plate and grid circuits. The latter method is illustrated in Fig. 15 and uses a line terminated with a resistance equal to the characteristic impedance of the line. Since the velocity of propagation along the line is independent of the frequency, for frequencies under consideration, a change of oscillation frequency will produce a change in phase of the voltage at the terminated end of the line and thereby shift the phase of the excitation voltage to the oscillator grid in a direction tending to oppose the original frequency shift.

A very good example of a coaxial line controlling the frequency of a push pull oscillator is shown in Fig. 16. This circuit applies the half-wave line, open-circuited at both ends and particularly suited to push pull circuits. The nearer the tapping points are to the center of the half-wave line the less the power output of the oscillator.

In conclusion, the following important points summarize the features which must be considered to increase the stability of an oscillator. (1) The tube should have a high enough  $G_m$  and  $R_p$  to hold the frequency variation within the specified tolerance. (2) The grid current should be as low as possible and the percentage of feedback just sufficient to satisfy the equation  $A \cdot B$  equal unity. (3) The effective coil resistance should be as low as possible. (4) The ratio of  $L/C$  should be low, which is another way of emphasizing (3) and also that the  $Q$  of the loaded tank coil should be high. (5) Introduction of series reactances may prove advantageous in many oscillator circuits and should not be overlooked.

## DIAL FEED PRESS

A dial feed press which enables an operator to handle four to six times as much work of certain types as he otherwise could produce on a conventional press is being manufactured by

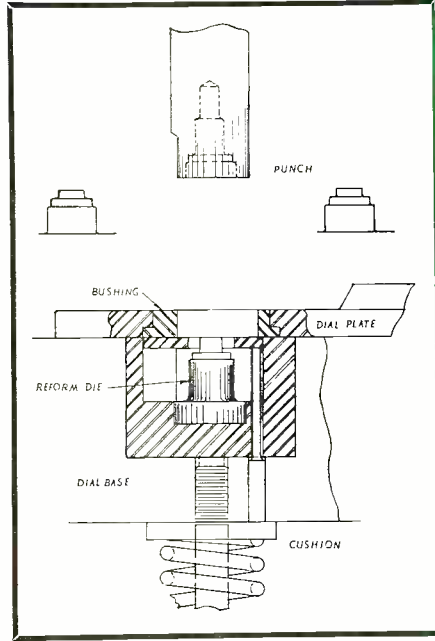

the *Federal Press Company*. The dial feeds are built to perform numerous secondary operations such as redrawing, piercing, broaching, wiring, punching and burring, on blanks and shells which have previously been blanked and drawn. These presses may also be used for many assembling, riveting and closing operations on finished parts and on material other than metal. The feeds may be set to perform several operations in sequence. For further details, contact the firm at Elkhart, Indiana.

## ROSEN & COMPANY REORGANIZES

*Raymond Rosen & Company* has announced the formation of a new wholly-owned subsidiary company, to be known as *Raymond Rosen Engineering Products, Inc.* It will handle all of the business formerly taken care of by the Engineering Products Division.

President of the new firm, Mr. R. Rosen, stated that this small division of the *R. Rosen & Co.*, intended to handle the specialized phases of sound, communication and electronic engineering and development work, expanded until it represented a substantial portion of the total business. Since this business is distinct in character from the merchandising end of the business, it was

decided to organize a new company, in order to provide for further growth and better service. Some of the former jobs of the Engineering Products Division include the sound system for the Republican and Democratic national conventions and the radio communications equipment used by the Pennsylvania Turnpike Super Highway.

\* \* \*

## NEW CORPORATION

The formation of *Crown Capacitor Corporation* at 316 Sawyer St., Boston, Mass., was recently announced. The organization is producing a line of fixed paper capacitors. Their special sized units conform to limited space requirements with tolerances on capacitance within a margin of plus or minus five per-cent. Mr. J. H. McCulloch is the chief engineer and Mr. J. D. Blumenthal, general manager.

\* \* \*

## TUBE IN THE MAKING

Tungsten, vital to electron tube filaments and heaters, starts as a fused bar of controlled powder particles. Size, distribution and grain boundaries of individual crystals are carefully studied by means of optical microscope and projected image before the material is hot swaged and hot drawn to fine ductile filamentary material. The section of

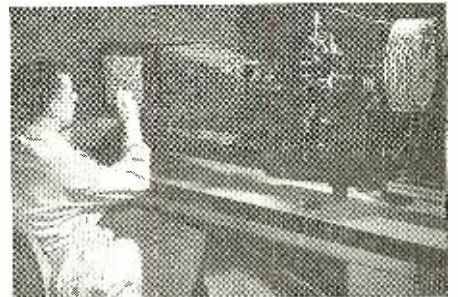

the process shown here is at the Tungsten & Chemicals Division, *Sylvania Electric Products, Inc.*, Towanda, Pa.

\* \* \*

## NAVY CONFERS WITH ELECTRONIC SUPPLIERS

In order to clarify the missions and current programs of the Electronic Supply System of the U.S. Navy, representatives of the Electronic Supply Office met with representatives of some thirty Naval supply activities located in the States and at island bases for a four-day conference. Among topics discussed were procurement of new equipment and purchasing problems.

—(3)—

# Personals

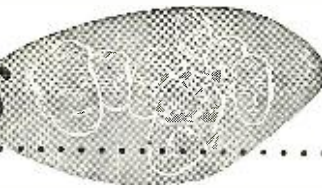

**DR. A. V. ASTIN**, assistant chief of the Electronics Division of the National Bureau of Standards, has been notified by the British Embassy that he has been awarded His Majesty's medal for Service in the Cause of Freedom. Dr. Astin was in England from 1944 to 1945 as representative of the NBS and the National Defense Research Council. His work at that time involved the use and evaluation of the radio proximity fuse.



**R. J. HARTUNG**, formerly assistant controller of the Radio Tube Division of *Sylvania Electric Products, Inc.*, Emporium, Pennsylvania, has been promoted to controller of this division. He joined the staff of *Sylvania* in 1946, as manager of the Radio Division accounting department. Previous to this he had served as a Lt. Commander in the Navy, and was associated with *Haskell & Sells*, certified public accountants. He received his B.S. in economics at the U. of Pa.



**LEW HOWARD** has been appointed a representative of West Coast Electronic Mfg. Assn. on the board of directors of the Radio Parts and Equipment Shows, Inc., Chicago. He will represent both the San Francisco and Los Angeles Councils of the WCEMA. He is also chairman of the 4th annual Pacific Electronic Exhibit to be held in Los Angeles Biltmore September 30 and October 1-2. This will mark the third trade show on which he has served as a committeeman.



**HARVEY W. SMITH** has joined the engineering staff of *Lenkurt Electric Company* of San Carlos, Calif. He will be in full charge of design and construction of high-quality transformers both for carrier application and custom manufacture. Mr. Smith was formerly an independent consultant, a chief engineer at *Peerless Electrical Products Co.* and a member of engineering staffs at *Bendix Aviation, Ltd.*, *Audio Products Co.*, and *Electrical Research Products, Inc.*



**DONALD E. WARD** is the new Sales Manager of *Reeves Soundcraft Corporation*, according to an announcement made by A. C. Travis, Jr., vice president. Mr. Ward was associated with *Audio Devices* and *Muzak* before he joined the *Reeves* firm as an assistant sales manager in 1946. His additional responsibilities now are a result of increasing company activity in the recording disc field and a greatly accelerated national sales campaign.



**HARRY DIAMOND**, Chief of the Electronics Division of the National Bureau of Standards, died suddenly at his Washington home on June 21, 1948. He was widely recognized for his administrative ability and brilliant scientific achievements. Outstanding of these were his contributions to the radio proximity fuse and instrument landing system.

## Capacity Transducer

(Continued from page 7)

capacity shunts the r.f. feedback of the grid of the oscillator tube to ground. Thus, every time the vane passes a pickup element, the oscillator output dips. Thus this input capacity as well as the size of the feedback variable condenser may determine optimum oscillator frequency.

The size of the variable condenser will depend upon three feedback functions: frequency of oscillation, feedback ratio in tank coil, and cable and pickup shunting capacity. This may best be determined experimentally for each individual application. As the variable condenser is adjusted to the point where the oscillator is not oscillating strongly, some means must be supplied to determine this point. This is accomplished with the aid of the 1.5 ma. meter, which indicates rectified r.f. current from the detector. The output winding on the tank coil is wound so as to give a 1.0 to 1.5 ma. indication on the meter when

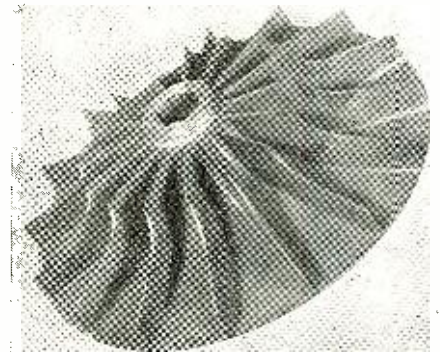

The impeller next to which the capacity pickup was used.

the oscillator is functioning correctly. This winding may be determined experimentally and is not too critical. The oscillator is adjusted to give maximum r.f. voltage change and the winding would to give some selected reference point on a meter.

A 1N34 detector was selected to simplify maintenance and construction of the transducer unit. In some units this was direct-coupled to the amplifier, but this was not found necessary or desirable on later units as operation to zero r.p.m. or frequency was not required.

The output impedance of the transducer unit may be a critical item, even though the output voltage is high and a shielded cable is to be used. This is because of the possible high output frequency. A sixteen blade impeller rotating at 30,000 r.p.m. has an output frequency of 16 times 30,000 divided by 60. This gives an output frequency of 8000 cycles. Therefore, for these units an RG 7/U cable (14  $\mu$ fd./ft.) was used to connect the transducer to the



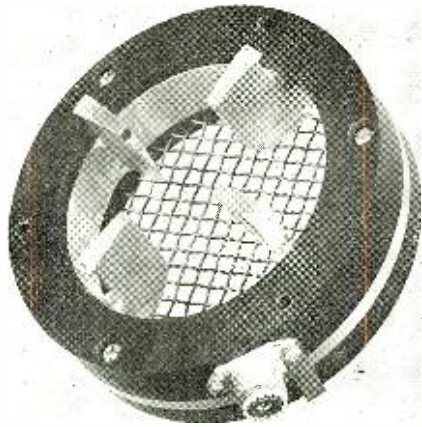

This 4 vane pickup was used successfully to record r.p.m. in excess of 30,000.

tachometer. This lowered the shunting capacity on this high impedance line, allowing a longer cable. It would be desirable to use a plate to 500 ohm line transformer in the transducer and a 500 ohm line to grid transformer at the frequency meter on future developments. Thus there would be no limitations on cable length between these two units.

The r.p.m. may be read directly on an *H-P* Electronic Tachometer where one cycle is produced per revolution at the pickup. Where many bladed devices are used it is preferable to use an *H-P* Electronic Frequency meter. In this case, r.p.m. may be read by using the calculation  $r.p.m. = \text{Freq. meter} \times 60 / \text{No. of blades}$ . This calculation may be reduced to chart form, but it is preferable to draw a new scale to be used with the instrument.

For vibration analysis, in general terms, the same pieces of equipment may be used. There are variations, of course, depending upon the required indications. An electronic frequency meter would still be required where frequency of vibration is the main item of interest. Where displacement measurements are required, these may be made with a calibrated output meter. These meter calibrations may be made very accurately using an optically scaled microscope and a light source to measure vibration amplitude of the capacity pickup on a test stand.

As the transducer unit has high output, it may be used directly into an oscilloscope or recording oscilloscope.

The pickup unit now enters the picture, and well it might, for there are no capacity pickups which will produce output frequencies of  $\frac{1}{4}$  cycle per second. That is low frequency. Output to this and lower frequencies are possible, though, where the capacity pickup is a two-unit affair. Here one plate of the capacity unit is fastened to the moving part (or it may consist of part of the moving machinery) and the

other or "hot" plate is fastened to a non-moving object and connected to the transducer.

Capacity vibration pickups are nothing new and the experimental pickup shown in the photograph simply consists of two-by-three inch sheet of dural clamped at the ends and weighted in the center by a small weight. This sheet is the hot plate and works against a fixed plate. Although not calibrated, it produces roughly three to five volts of r.m.s. output at 60 c.p.s. at .010" to .040" vibration.

This transducer unit should find wide use in many fields due to its electrical simplicity and high sensitivity.



## New Products

(Continued from page 23)

The unit will dissipate 3000 watts with a 40° F. temperature rise.

### ELECTRONIC ROBOT

One of the most unusual electronic devices recently put on the market is made by the *St. Louis Microphone Co.*, 2726-28 Brentwood Blvd., St. Louis 17, Mo. The complete equipment consists



of a recorder, player, control and amplifier, 25 recording blanks and instructions, a dynamic microphone cable and desk stand, 50 ft. robot head interconnecting cable, electric eye and speaker head, and electric eye light source.

The robot can be used for selling and advertising and making public announcements. The tricks the robot can do are limited only by the ingenuity of the operator.



### Photo Credits

Page	
3.....	International Business Machines Corporation
14, 20.....	Federal Telecommunication Laboratories
24, 25.....	General Instrument Corporation

# TECHNICAL BOOKS

"FLUORESCENT AND OTHER GASEOUS DISCHARGE LAMPS," William E. Forsythe and Elliot Q. Adams. Published by *Murray Hill Books, Inc.*, 232 Madison Ave., New York 16, N. Y. 292 pages. Price \$5.00.

This volume presents a thorough, comprehensive treatment which starts with earliest beginnings of the fluorescent lamp and takes the reader through an analysis of every factor influencing the construction and performance of these lamps.

The first chapters lay a foundation of theory, covering light, radiation, and the discharge of electricity through gases and vapors, then treat in detail the basic principle of the fluorescent lamp, its essential parts, problems of operation, and efficiency. Types of phosphors are emphasized and experimental results and design and engineering data are included.

Successive parts deal with essential engineering details of sun lamps, germicidal lamps, infrared signaling devices and telescope television types, photographic flash lamps and others.

In all, the book is clear and sound in treatment, bringing to the reader the bulk of essential information needed for a complete engineering and working knowledge of fluorescent and other gaseous discharge lamps, suitable to the consideration of any technical problems involved in their design and application.

"INDUSTRIAL ELECTRONICS REFERENCE BOOK," Electronics Engineers of the *Westinghouse Electric Corporation*. Published by *John Wiley & Sons, Inc.*, 404 Fourth Ave., New York, N. Y. 680 pages. Price \$7.50.

Aimed at the practicing engineer who is faced with the problem of understanding the underlying principles as well as the scope and limiting factors of electronic apparatus as it is applied to industrial processes, this book deals with basic theory and application of electronics. It was written by a group of engineers, each thoroughly versed in his particular branch of the subject.

Hundreds of illustrations help to elucidate every phase of the text material. The extensive lists of references at the end of each chapter will aid the reader in locating additional material on any of the specific subjects involved.

This comprehensive digest should prove a very handy reference for the industrial electronics engineer.



An Answer to Your Needs!

# RADIO TEST INSTRUMENTS

by Rufus P. Turner  
Consulting Engineer, RADIO NEWS

REVISED EDITION  
NOW AVAILABLE!

**TELLS HOW TO CONSTRUCT, CALIBRATE, AND USE ELECTRONIC AND RADIO TEST EQUIPMENT**

This well illustrated and practical manual will be an asset to any radio man's service library. It shows how to build, how to properly calibrate, how to use dozens of different types of radio and electronic testing devices. It covers briefly the theoretical explanation of radio, but only to make sure the reader first understands electrical and radio theory. The major portion of the book is devoted to technical data, which is presented in clear, understandable language. An ideal text for the practical radio man and a *must* for the radio serviceman.

### Graphically Illustrated

Included are 182 informative illustrations—diagrams, charts, tables, and photographs—carefully chosen by the author to illustrate his sixteen chapters. RADIO TEST INSTRUMENTS is a unique presentation of a culmination of the author's own practices and applications. He has constructed and calibrated, tested and built, each piece of equipment described. And he shows how you can build and use these test instruments.

### Covers Fully All These Test Instruments

- Multipliers
- Resistors
- Multi-Range Voltmeters
- Multi-Range Ammeters
- Ohmmeters
- Ultra-High-Resistance Meg-ohmmeters
- Volt-Ohm-Milliammeters
- Wattmeters
- Vacuum-Tube Voltmeters
- Decibel Meters
- Bridge-Type Impedance Meters
- Direct-Reading Impedance Meters
- Simple Capacitor Checkers
- Compact Capacitor Checkers
- Simple Coil Checkers
- Substitution-Type Capacitance Checkers
- Resonant Inductometers
- Precision Resistance Bridge
- High-Gain Null Detectors
- Oscilloscopes
- R.F. Test Oscillators
- and many others

Price \$4.50. Use convenient coupon with full return privilege

**ZIFF-DAVIS PUBLISHING COMPANY**  
185 North Wabash Avenue, Chicago 1, Ill.

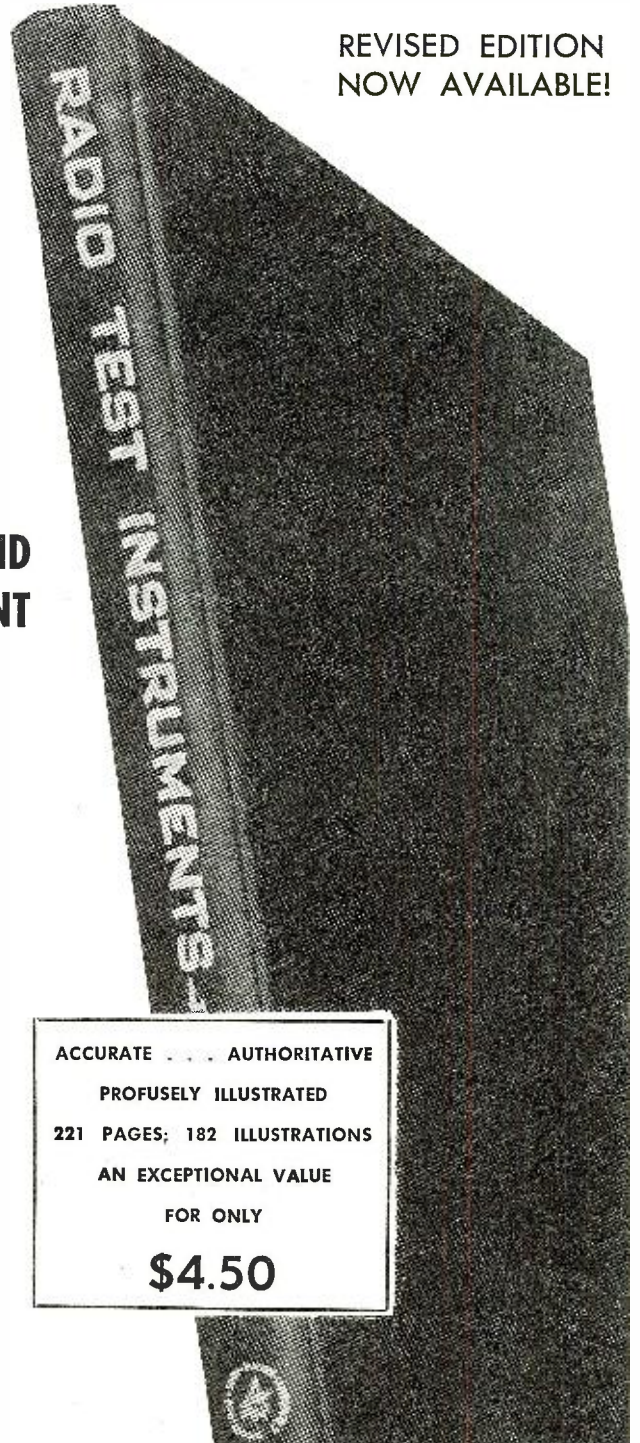

ACCURATE . . . AUTHORITY  
 PROFUSELY ILLUSTRATED  
 221 PAGES; 182 ILLUSTRATIONS  
 AN EXCEPTIONAL VALUE  
 FOR ONLY  
**\$4.50**

**MAIL THIS COUPON TODAY**

Ziff-Davis Publishing Company, Dept. REE  
 185 North Wabash Ave., Chicago 1, Ill.

I am enclosing \$4.50 (check or money order) for which please send me one copy of RADIO TEST INSTRUMENTS. I understand that I may return book within five days for full refund if I am not entirely pleased.

Name .....

Address .....

City ..... State .....

# MICROWAVE PLUMBING REPLACES CIRCUITRY

By  
**SAMUEL FREEDMAN**  
DeMornay Budd, Inc.

**Basic microwave transmitter  
in its simplest form need be  
no more than a tube and some  
microwave plumbing or pipe!**

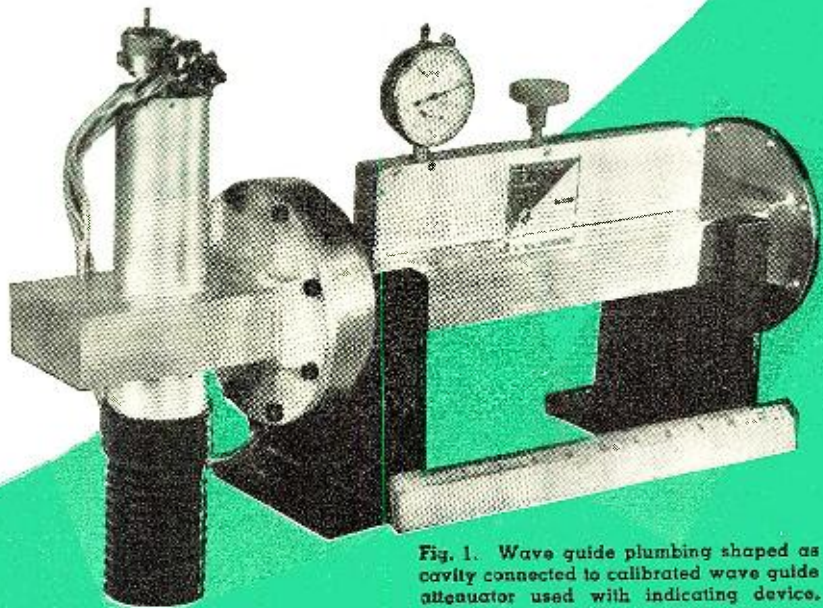

Fig. 1. Wave guide plumbing shaped as cavity connected to calibrated wave guide attenuator used with indicating device.

NO ANYONE whose past association with radio has been with frequencies below about 1000 megacycles, microwaves are unique in every respect. The basic difference between lower radio frequencies and microwaves is that inductive and capacitive effects are utilized in lieu of coils and condensers. It is achieved by direct action on the magnetic and electric fields through the use of special structures such as simple pipes (called wave guides) of suitable shape and dimension. This is both a necessity and an advantage for microwaves.

At conventional radio frequencies, the physical dimensions of inductance in the form of coils or conductors, and of capacitance in the form of condensers are specially provided or "lumped." Their physical size is very small with respect to the operating wavelength.

At microwave radio frequencies the physical dimensions of any conductor or condenser are large with respect to the wavelength involved. So little inductance and capacitance is required that the circuit may work best, or only, when "distributed" rather than lumped inductance and capacitance is provided. This may be little more than that represented by the electrodes, their separation, and the connections to the vacuum tube.

No wire is efficient in conducting energy at extremely high a.c. frequencies as represented by ultra or super high frequencies. Instead the wire behaves like an a.c. insulator even

though at d.c. or low radio frequencies it is an excellent conductor. The reactance or a.c. impedance of any wire or coil increases with increase of frequency. Specifically, it must increase because the inductive reactance in ohms is always equal to:  $6.2832 \times \text{frequency in cycles} \times \text{inductance in henrys}$ .

Conversely, no condenser is efficient in blocking a.c. energy at extremely high a.c. frequencies because it behaves like a virtual short-circuit or conducting path at microwave frequencies. This is true even though d.c. or low radio frequencies are effectively blocked or isolated by the same condenser. The reactance or a.c. impedance across a condenser decreases with increase of frequency. Specifically, capacitive reactance in ohms must decrease since it is always equal to:  $1/6.2832 \times \text{frequency in cycles} \times \text{capacitance in farads}$ .

The fact that inductance behaves like an insulator instead of a conductor, and capacitance behaves like a short circuit or conducting path instead of an r.f. block, requires that energy be propagated rather than conducted from point to point even in the case of very short distances within an equipment.

The concept now is that d.c. is really a.c. at zero cycles or infinite wavelength. As the a.c. frequency increases from zero, a conductor steadily decreases in its ability to conduct a.c. while a condenser increases. The result is a reversal in radio concepts

as the frequencies reach into the microwave region.

While propagation of microwave energy in free space is quite conventional for direct paths, it is only during the past few years, even experimentally, that it has been utilized within the equipment itself or for the antenna transmission line system. This propagation technique is achieved by the use of wave guides. Wave guides are simple pipes, usually rectangular, in which one wall simulates the ionosphere and the other wall simulates the earth. The concept is comparable to sky wave propagation on low frequencies in free space. A quarter-wave dipole (miniature at microwaves) at the points of introducing and of extracting the energy may be compared with the transmitting and receiving antennas for lower frequency radio operations in free space.

Fig. 2 shows the physical evolution of a wave guide. Fig. 2A shows two wires of any length. It may correspond to the open line shown in Fig. 5. Fig. 2B shows a quarter wavelength shorted line corresponding to the first 90 degrees for the shorted line in Fig. 5. Fig. 2C shows the quarter-wave short of Fig. 2B attached to the open line of Fig. 2A. Note that the point of attachment is the point of maximum impedance for a shorted line a quarter wavelength removed from the short. The current will be zero while the voltage will be maximum at that point. Remember that there is only a.c. sine wave behavior to consider

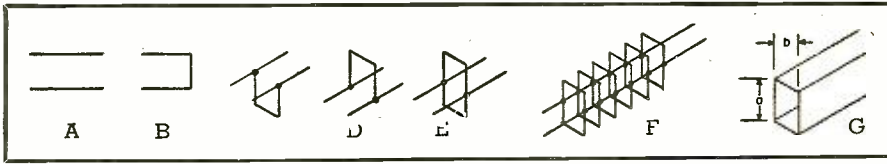

Fig. 2. Physical evolution of a rectangular wave guide.

and dimensions are being held correct for the frequency and the wavelength. Fig. 2D shows the same type of quarter-wave short on the opposite side of the parallel wires. Fig. 2E shows the closed loop formed by Figs. 2C and 2D combined. Although it is a d.c. short, it is an open circuit for a.c. because it offers maximum impedance at the point of attachment by virtue of the fact that each shorting section is a quarter wavelength long. A sine energy wave that is maximum at one point will be minimum a quarter wavelength removed. These shorts are really "metallic insulators" much more nearly a perfect insulator than any conventional ceramic insulator

could ever be with respect to either d.c. or a.c. Fig. 2F shows a number of loops like that depicted in Fig. 2E. Fig. 2G shows the end result when there are an infinite number of loops so closely spaced that they become a solid pipe.

Fig. 3 shows the energy distribution in a wave guide or rectangular pipe. It is necessary to forget the usual conduction principle where a wire carrying a.c. has an associated varying magnetic field encompassing it; or where a varying magnetic field cutting the terminals of such a wire. Instead, it is necessary to think of the displacement current principle which requires no wire to carry the energy. It operates on exactly the same principle that electromagnetic waves propagate in free space from a transmitting antenna to a receiving antenna without a physical link between them. The displacement technique operates on the principle that a dielectric or empty space can be substituted for a wire or coil. If the width of the wave guide exceeds a half wavelength and does not exceed a full wavelength in diameter, the wave guide operates on its dominant mode (known as  $TE_{0,1}$ ) and there will be an energy distribution as shown in Fig. 3. The dominant mode indicates the lowest frequency possible to develop in a wave guide. When the dominant mode is known as  $TE_{0,1}$  (the most common type encountered in practice), it means transverse electric type with the electric field component in the wave guide perpendicular to the axis of the guide. It has no electric component along the length or long axis of the wave guide. 0,1 or 1,0 means that there is one half-wave pattern of electric lines across the cross section of a wave guide along one dimension while there is zero half-wave patterns of electric lines across a dimension at right angles to the first, or vice versa. Note particularly, the following details in Fig. 3:

manner. If the wave guide diameter is doubled for a given wavelength, or if the wavelength is halved for a given diameter wave guide, then in this example, there would be a  $TE_{2,0}$  or  $TE_{0,2}$  mode in which two parallel sets of the pattern illustrated in Fig. 3 would exist.  $TE_{3,0}$  would mean that the wave guide diameter exceeds a wavelength and a half, etc. To avoid multi-modding with the energy divided between these different modes or energy patterns, the wave guide diameter must be less than a wavelength. Multi-modding may be used where it is not feasible to shrink the wave guide size or lower the frequency. In such event, care must be taken not to couple at a zero energy point.

3. A magnetic field (shown by dotted circular lines) corresponds to the field which would exist around a wire if an electric current were flowing in same. It is distorted to square circles because the wave guide is rectangular in shape. The field alternates in direction each half wavelength in accordance with the sinusoidal characteristic.

4. Energy may be introduced or extracted most efficiently if a quarter-wave dipole protrudes into the wave guide at any point where the electric field is maximum plus or minus in the illustration.

5. Energy may also be introduced or extracted, alternately or optionally, if a small loop is provided in the center of the narrow side of the wave guide pipe so that it couples to the magnetic field. It is immaterial whether a dipole is used with the optimum position of the electric field or if a loop is used with the optimum position of the magnetic field.

Fig. 4 compares propagation in a wave guide pipe on microwaves with that of the ionosphere and the earth from a lower frequency transmitting station. There is little difference between a low frequency radio station propagating long waves in the many miles separation between the earth and the ionosphere, and a microwave transmitter propagating miniature waves between the two walls of a small pipe. The wave guide pipe will be more efficient and stable since its walls, of good electrical conductivity, facilitate reflection and it is free of changes in dimension due to night and day, seasons or sunspot cycles. The pipe dimensions should be 3" x 1 1/2" at 3000 megacycles, dropping to 1/2" x 1/4" at 30,000 megacycles.

To propagate energy in a wave guide, it must be below cut-off dimension in wavelength or above cut-off dimension in frequency. If the wave guide dimension in Fig. 4A is less than a half wavelength, energy cannot enter or be accommodated. If it is at "cut-off" or exactly a half wavelength, the energy can be accommodated as illustrated in Fig. 4A but it will not make propagational progress down the wave guide's longitudinal axis. Attenuation will be total as the energy will bounce back and forth at one

Fig. 3. Energy distribution in a rectangular wave guide operated at the dominant or  $TE_{0,1}$  mode.

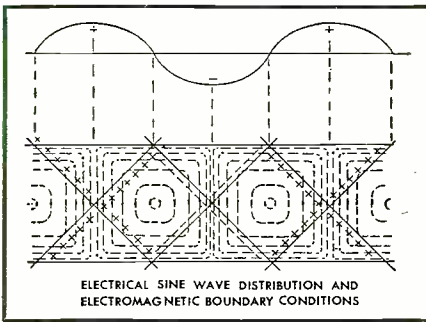

Fig. 4. Free space propagation versus propagation in a wave guide.

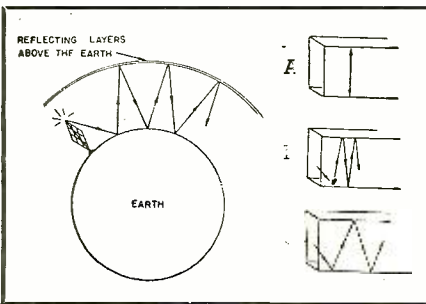
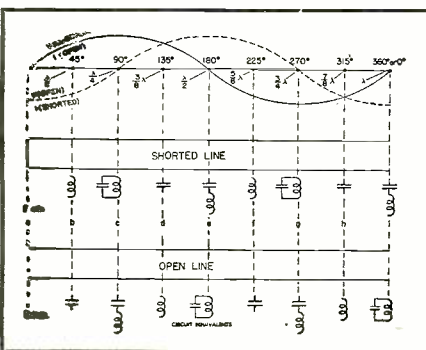

Fig. 5. Inductive and capacitive effects in a two-wire line or wave guide.



1. The voltage cancels out at the side walls to equal a total of zero shown by plus and minus meeting at the boundary.

2. The electric field at the center of the wave guide diameter (equidistant from the boundary walls) adds rather than cancels out (plus and plus or minus and minus meet) to result in a sine wave energy distribution as illustrated. This is a simplified form of "Poynting's Vector" to facilitate a graphic portrayal of how the electric component must be zero at the boundaries and maximum between the boundaries but varying in a sinusoidal

spot, undergoing a loss each time it reflects at a wall. If the wave guide is more than a half wavelength in width, as in the case of Fig. 4B, the energy will make progress at some angle, as shown. The attenuation will go down since there will be less points of contact for reflection to the opposite wall or boundary. If the wave guide width is further increased, the reflecting angle will increase so there will be still less points of contact, further reduction in attenuation losses and greater efficiency in propagation of energy down the wave guide.

Fig. 4B might be compared with sky wave propagation at medium frequency while Fig. 4C might be compared with sky wave propagation at high frequency as commonly known for standard and shortwave broadcasting or for amateur radio communication. The principle is similar. The velocity of energy in a wave guide is less than it is in free space for direct path communication. It cannot be 186,000 miles-per-second because the energy takes a zigzag path. Its velocity would only be comparable if it did not have to reflect from wall to wall. It is zero at cut-off (Fig. 4A) and increases as the angle widens out in Fig. 4C. Think of it as 186,000 miles-per-second along the zigzag route illustrated with actual velocity from one end to the other end of the wave guide being its resultant straight line distance. It is comparable to a caterpillar whose wiggles appear to move faster than the progress it is making over the ground.

The power handling capacity of a wave guide is much greater than is possible with any practical size conductor. At 3000 megacycles, the 3" x 1½" wave guide can handle over 3,000,000 watts of energy without arcing between the narrow wall dimensions. Only two opposite surfaces of the wave guide are required. The other two are merely for keeping the parallel surfaces properly spaced. The ionosphere and the earth may be considered as "Nature's wave guide" while the pipes may be called "fabricated wave guide."

Fig. 5 shows how wave guide pipe replaces inductance, capacitance, parallel resonant LC or series resonant LC circuits. By moving a dipole probe back and forth through a slit in the wave guide wall, it behaves like a tunable or variable inductance or capacitance. The behavior of an open-ended and shorted line is identical except that they duplicate their phenomena a quarter-wave length or 90 electrical degrees removed from each other.

The net result is that the basic microwave transmitter, in its simplest form, need be no more than a vacuum tube and a piece of microwave plumbing or pipe as illustrated in Figs. 1 and 6. This is the same technique developed by Fonda and Freedman which was discussed in the article "Generating Microwaves" in the

POINT	SHORTED LINE	OPEN LINE
"a" 0 or 360 degrees	1. Minimum impedance. 2. Minimum voltage. 3. Maximum current.	1. Maximum impedance. 2. Maximum voltage. 3. Minimum current.
"c" 90 degrees quarter-wavelength	Same as for the open line at point "a". It behaves like a parallel resonant LC circuit.	Same as for the shorted line at point "a." It behaves like a series resonant LC circuit.
"e" 180 degrees half-wavelength	Same as for open line at point "c".	Same as for shorted line at point "c".
"g" 270 degrees three-quarter wavelength	Same as condition "c" for shorted line.	Same as for condition "c" for the open line.
"i" 360 degrees or any multiple thereof	Same as condition "e" for the shorted line.	Same as condition "e" for the open line.

Table 1. Data shown indicates various conditions for shorted and open lines. Reference should be made to Fig. 5 for details on points "a", "c", "e", "g" and "i".

March, 1947 issue of RADIO NEWS. This particular unit uses a Type 6V6 operating at a choice of frequencies in the vicinity of 2860 megacycles. In this illustration energy coupled by a loop through the wave guide cavity hole shown in Fig. 6 is fed through a calibrated wave guide attenuator to an indicating instrument.

The same phenomena and results possible at microwave frequencies may also be realized at any frequency or wavelength as long as the physical requirements prove feasible, and can be utilized. For example, a complete set of events (half wavelength) involves dimension of .2 inch at 30,000 megacycles (1 centimeter wavelength.) The dimension would have to be 20 inches at 300 megacycles (1 meter wavelength). In the broadcast band, at 1000 kilocycles, the dimension would be 500 feet. This statement can be readily appreciated by anyone using an automobile radio on the highway. When the vehicle goes into a tunnel or underpass (even for a few feet), the signal goes dead on the broadcast band while working normally on very high frequencies (such as two-way mobile radio) and still better on microwaves. Microwaves are incomparable for operation

in subways or tunnels. Every tunnel, underpass, sides of steel bridges, walls between two sides of a street, two sides of a gorge or canyon etc., forms a wave guide. Energy propagates best there, if at all, when it can accommodate more than a half wavelength for the equivalent of its diameter.

The phenomena possible to develop with simple plumbing or mere pipe on microwaves, therefore, make possible results that on lower radio frequencies always require coils, condensers, transformers, resistors, and insulators. These can be eliminated on microwaves by utilizing the inversion, capacitive, inductive, and transformation effects existing along some quarter wavelength of any over-all half wavelength for either an open or a shorted line. The impedance in a wave guide may be anything from virtual zero to virtual infinity somewhere along its length. For example, in Fig. 5, there are spotted the conditions and behaviors of Table 1. Any values between those indicated can be developed at intermediate distances.

The possibilities for using wave guides are as numerous as applications for the vacuum tube. Both are limited only by human imagination and  
(Continued on page 132)

Fig. 6. Dismantled view of equipment in Fig. 1, showing a conventional receiving tube used to generate microwaves. The fundamental and harmonic frequencies are masked out because the wave guide dimension is below cut-off for frequencies below about 2800 megacycles. The tube operates at transit time equal to seven periods of oscillation for generating 2860 megacycles in this case. It may be varied by electrode voltages or physical adjustment.

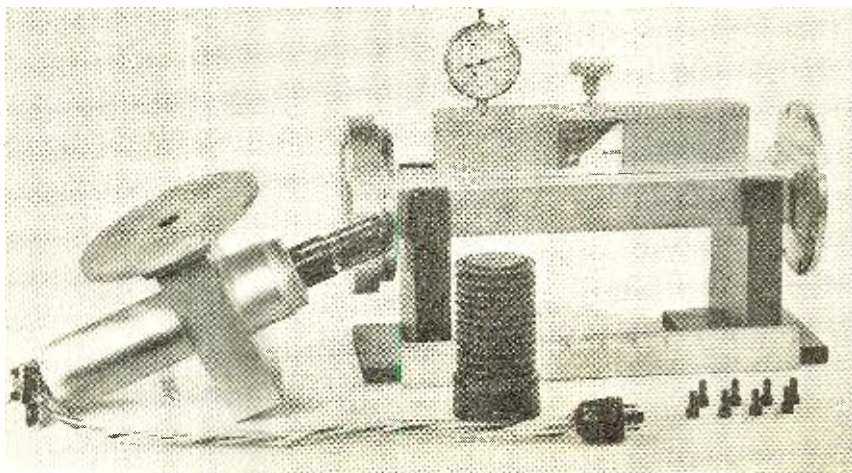

# A Portable, Lightweight, 1-Tube STROBOSCOPE

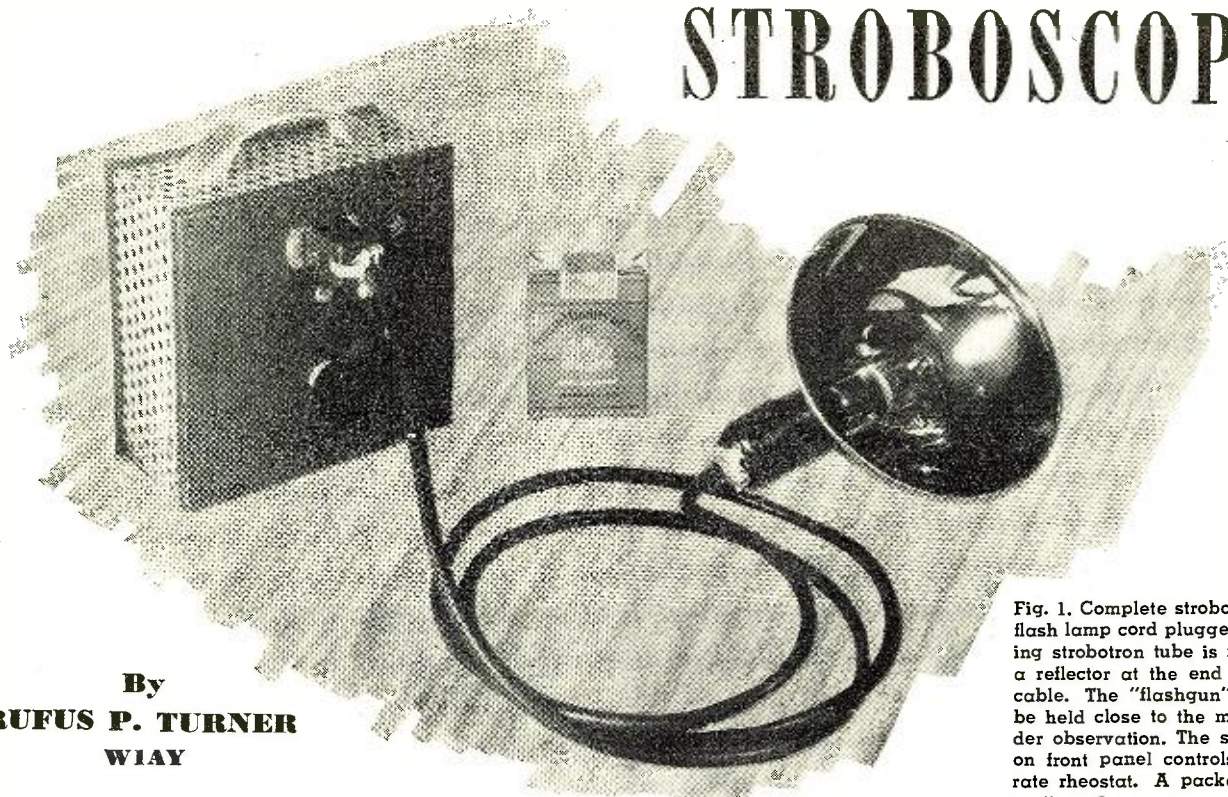

By  
**RUFUS P. TURNER**  
WIAY

Fig. 1. Complete stroboscope with flash lamp cord plugged in. Flashing strobotron tube is mounted in a reflector at the end of a 5-foot cable. The "flashgun" may thus be held close to the machine under observation. The single knob on front panel controls the flash rate rheostat. A package of cigarettes shows comparative size.

***This novel stroboscope is light in weight, small in size, instantaneous in action, and stable. It has a useful frequency range and is easy to build.***

THE stroboscope is one of the most useful of all everyday industrial electronic devices. Under the controlled-rate light flashes from this instrument, rapidly moving machinery is "frozen" in action, so that rotating, vibrating, sliding, reciprocating, and other recurrently moving parts may be studied while actually in motion although apparently standing dead still. The rate of speed or movement of these parts, such as the number of revolutions per minute, may be read from the stroboscope calibration. Since its introduction some years ago by Edgerton, Germeshausen, and Grier, the stroboscope has become an invaluable tool in the whole gamut of modern industries producing or using all forms of moving machinery and devices.

The stroboscope is useful to radio and electronic technicians in the examination and adjustment of auto radio vibrators, buzzers, tuning forks, vibrating reeds, motors, speakers, phonograph turntables and driving mechanisms, wire recorder mechanisms, antenna rotators, etc. If the radio serviceman also repairs electrical ap-

pliances, he will find the stroboscope handy in checking and timing such devices as electric fans, gear trains in electrical toys, electric clocks, motor-driven tools, drink mixers, kitchen mixers, electric razors, massage vibrators, movie projectors, etc. One electrician of the author's acquaintance even reports that he got the lowdown on what was happening to an electric hedge clipper by watching its operation under stroboscopic light.

Fig. 2. Rear view of flashgun assembly. The metal reflector is from a photographic flash gun. The mounting bracket, supplied with the reflector, has been fastened to the cable-end tube socket shell by means of two screws. The flashbulb socket hole was reamed out to pass the strobotron tube. See Fig. 4 for complete details on construction.



Most stroboscopes are rather bulky. They contain several tubes operated by transformer-type a.c. power supplies which are heavy. Moreover, the flashing lamp (strobotron tube) and its reflector generally are built into the large sized instrument, making it awkward to direct the light flashes into out-of-the-way spots.

The simple stroboscope described in this article is small-sized, being mounted in a 5" x 5" x 2½" case. It is light enough to be hung from the operator's neck like a photographic exposure meter or small camera. The flashing strobotron is the only tube employed and it is mounted in a metal reflector on the end of a detachable 5-foot cable. This latter feature permits the light source to be held or clipped close to the machine which is to be illuminated. Simplification of the circuit has been made possible by the use of a voltage doubler power supply built with two selenium rectifiers. Also, by using the strobotron tube itself in a relaxation-type variable-frequency oscillator, the usual separate pulsing circuit found in most stroboscopes has been eliminated. Aside from an "ON-OFF" power-line switch, this stroboscope has only one control—the frequency (flash rate) rheostat. The instrument is instantaneous in operation, starting up as soon as the switch is closed, since there are no filaments nor heaters to require a

waiting period. Fig. 1 shows the external view of the complete instrument.

### Circuit

Fig. 5 shows the complete circuit schematic of the miniature stroboscope.

The voltage doubler power supply section is comprised of two selenium rectifiers, electrolytic condensers  $C_1$  and  $C_2$ , filter resistor  $R_3$ , and filter condenser  $C_3$ .  $R_1$  and  $R_2$  are protective resistors for the rectifier units. The d.c. output of this power supply is a little over 300 volts when the a.c. line voltage is 115 r.m.s.

Resistors  $R_4$ ,  $R_5$ , and  $R_6$  and condensers  $C_4$  and  $C_5$  together with the strobotron tube, form a relaxation-type oscillator which has surprising frequency stability for a self-excited circuit. Rheostat  $R_5$  is the flash-rate control. The resistor-condenser values given in Fig. 5 afford a flash-rate range extending from 10 per second (600 per minute) at the high-resistance setting of control  $R_5$  to 112 per second (6720 per minute) at the low-resistance setting of  $R_5$ . This is a useful range covering most of the common motor speeds and vibration rates encountered in the field. A higher-resistance rheostat in the  $R_5$  position and a higher resistance at  $R_4$  will extend the low-frequency rate below the 10-per-second value (This will be of interest to phonograph repairmen). The high end of the range may be extended upward by omitting resistor  $R_6$  from the circuit.

The capacitance of the 4-lead cable connecting the strobotron tube to the circuit is a constant value and does not interfere with operation of the instrument. This cable may be held, coiled, or squeezed with no observable effect on the flashing rate of the tube.

For safety to the operator, no portion of the circuit is connected to the metal instrument case or to the reflector.

### Construction

Details of the stroboscope may be obtained from the accompanying photographs and drawings.

The instrument case is made of steel and is 5" x 5" x 2½" in size. The power supply components are mounted on the rear of one panel (side); the oscillator circuit components on the other. A 4-wire twisted cable of hook-up wire connects the power supply and oscillator circuits. This construction is shown in Fig. 6.

The sides of the case were made from perforated stock in order to provide proper ventilation. After completing and testing the instrument, however, heating was found to be negligible. It seems permissible, therefore, to use an entirely-enclosed case.

Fig. 6 shows the arrangement of components behind each of the two panels. Insulated terminal strips are used for mounting the resistors and condensers. The cable plug,  $P_1$ , is a

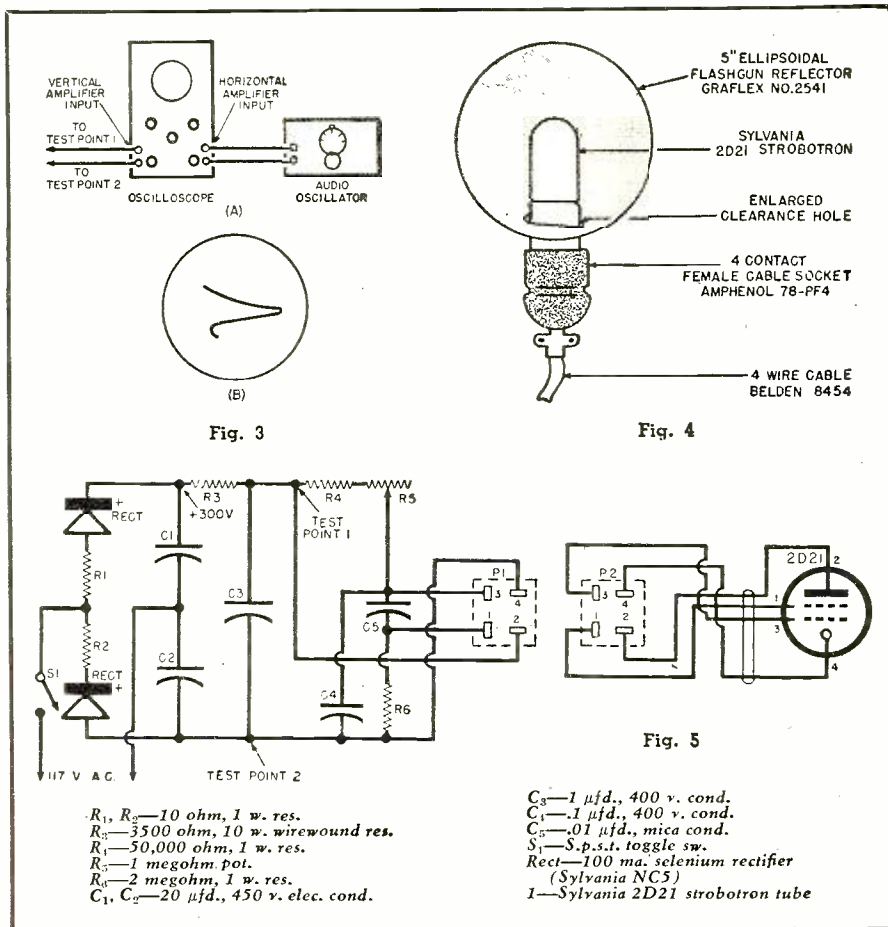

General construction details for stroboscope. Fig. 3. (A) Setup for calibrating frequency (flash-rate) control of unit. (B) Stationary single-pulse pattern obtained when oscillator frequency and stroboscope rate are equal. Fig. 4. Construction details of the light unit. Fig. 5. Complete schematic diagram for the stroboscope.

4-prong male unit (Jones P-304-AB). The companion female unit (Jones S-304-FHT) is mounted on the end of the flashgun cable. The two selenium rectifiers are stacked vertically on a long 6-32 screw.

Figs. 2 and 4 show construction of the flashgun. The reflector is a Graflex Cat. No. 2541 5-inch ellipsoidal photographic flashgun reflector obtainable at any camera supply house. (Continued on page 150).

Fig. 6. "Exploded" view of stroboscope case. Components of the circuit proper are mounted on the left-hand panel. The voltage doubler power supply is mounted on right-hand panel. Perforated sides of the case provide ventilation.

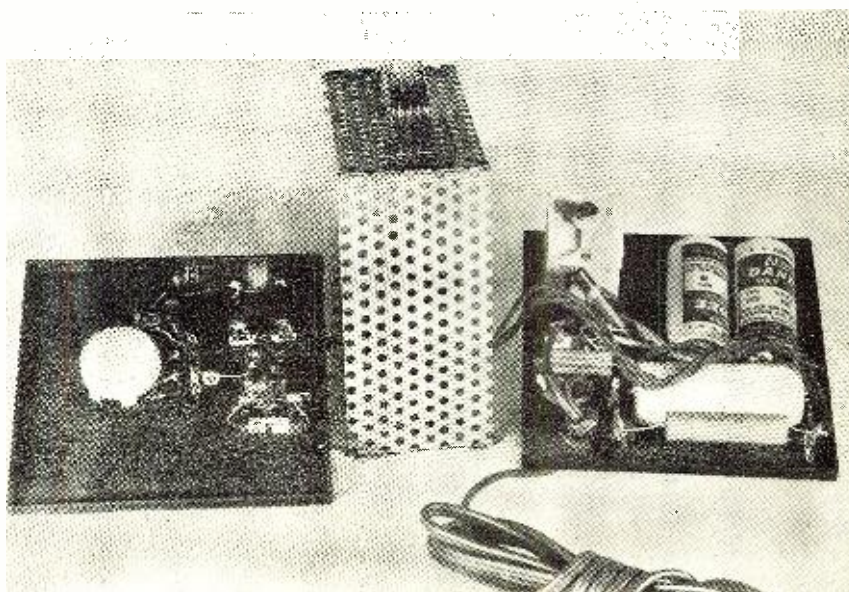

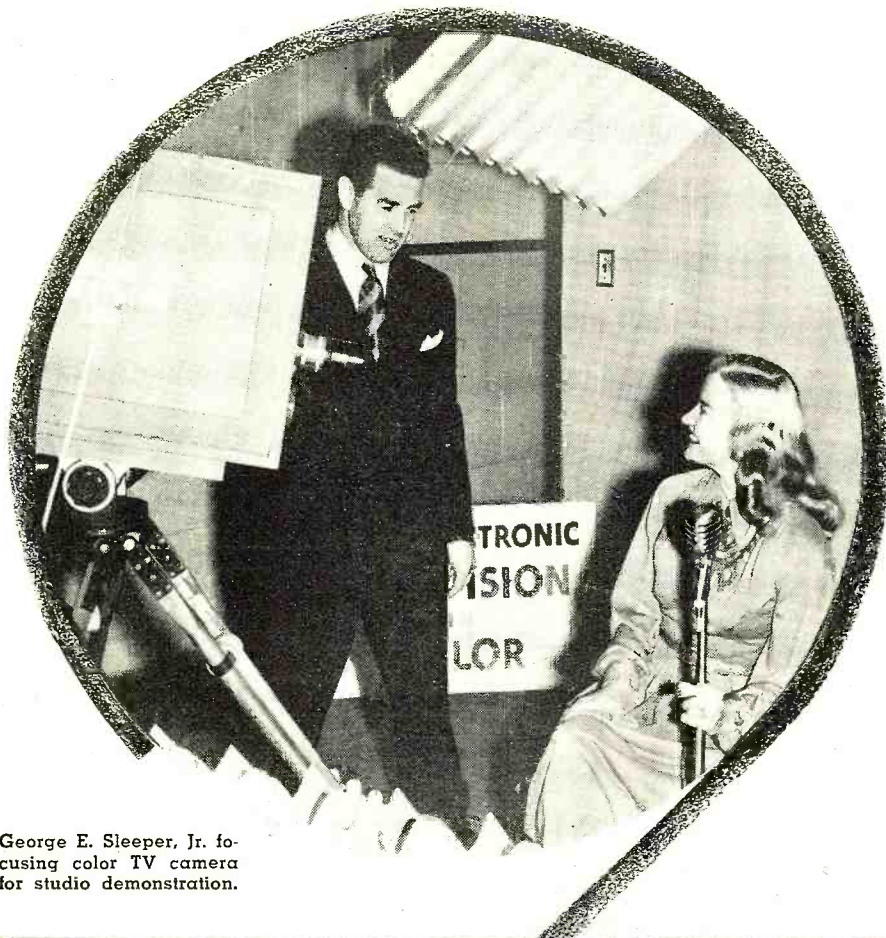

George E. Sleeper, Jr. focusing color TV camera for studio demonstration.

# Something New in COLOR TELEVISION

By RALPH CROSMAN

**Details of a new method of converting black and white TV equipment to permit color transmissions.**

A NEW process for converting black and white television equipment so that it is capable of transmitting and receiving pictures in natural colors, was demonstrated recently in the laboratory of *Color Television, Inc.*, San Francisco.

The conversion is made by adding three lenses and three color filters—red, green, and blue—to both the pick-up camera and the receiver. Instead of using three cathode-ray tubes, one for each color, the new method makes an ordinary black and white tube do the work.

The new process is based on inventions of George E. Sleeper, Jr., formerly television engineer for *Farns-*

*worth Television and Radio Corporation and Columbia Broadcasting System*, and now chief engineer for *Color Television, Inc.*

The patents, upon which the new color television system is largely based, cover, among other things; an electronic scanning device having a photoelectric screen with a single electron scanning beam; an optical lens system which produces a plurality of images of the object, interposed between the scanning device and the object; color filters associated with the apparatus for producing the plurality of images, one filter for each image; and a method for projecting the color images on the screen, each

color image being located on a separate area of the screen.

Two notable features of the system are its simplicity and its economy. In fact, generally speaking, it consists of apparatus that is similar to the black and white equipment now in use, except for the optical lens system which is employed at the camera and projection receiver, and the widening of the video amplifier system to approximately 12½ megacycles in order to pass the required bandwidth. Only one standard image orthicon tube is required at the camera, with a single electron beam, and only one projection tube is used at the receiver. The system is entirely electronic and there are no mechanically moving filters. The mixing of colors and the distortion of images, which is sometimes seen on the television screen, is entirely eliminated, as carry-over charges in the image orthicon, from one filter to another color filter, are impossible.

In regard to the economy of the system, it is stated that ordinary receiving sets using projection screens can be converted to color reproduction for about one hundred dollars.

In this system, stationary filters are used in conjunction with the special optical systems at the pick-up camera and in the reproducing receiver. At the receiver, superimposing lenses are used to register the three images, each in a different primary color (red, green, and blue) from the end of a single cathode-ray projection tube onto a projection screen.

The camera system consists of a standard black and white single image orthicon camera with a multiple image lens and filter system. Three optical images are focused side by side and are scanned as though they were a single image. The video signals generated are transmitted in the normal manner to standard black and white amplifier and mixing equipment, the necessary video bandwidth changes being made. Standard black and white line, frame, and super-synchronizing pulses are used to control the system. A standard black and white type of synchronizing generator supplies these pulses and requires no alteration. Colored pictures are reproduced from 525 line images in each filter color.

One of the chief differences between this system for converting black and white television to color and that used by *CBS* and *RCA*, it this: The *CBS* system is a frame-by-frame sequential color method. *RCA* has three separate tubes, each fluorescing in a different primary color, arranged in a triangular formation and operating simultaneously. In the new system, the three optical images are focused side by side and are scanned as though they were a single image, giving a single tube, line-by-line color reproduction.

Studio lighting for this system consists of daylight fluorescent lights pro-

(Continued on page 92)

RADIO & TELEVISION NEWS



# Hams Simulate Emergency Communications on Annual Field Day

**The Twelfth Annual Field Day brought activity among ham club groups to a new all-time high.**

Each year many amateurs look forward to the annual Field Day for testing of new emergency equipment, together with the fun this type of communications offers.

While the interest in the early Field Days was not too great, the event has grown in favor among amateurs, until it is now one of the most popular annual events, and awaited eagerly by many.

The Field Day stations vary from one-man setups to large elaborate installations with fifty or more operators participating.

Scoring is based on the number of stations contacted in the United States, its possessions, and Canada, with the various contestants being grouped in classes depending upon the number of transmitters in simultaneous operation. One point is scored for each station contacted. A multiplier may be used in computing the score, depending on the power input to the final stage of the transmitter. Stations operating at 30 watts or less input, may multiply their score by 3, while those using between 30 and 100 watts use a multiplier of 2. Stations operating solely from emergency power sources independent of commercial

mains use an additional multiplier of 3. For those stations operating solely from batteries, an additional multiplier of 1.5 may be used.

The rules were written to encourage the development of equipment capable of operating in an emergency when commercial sources of power fail.

Thus, a station operated solely from batteries, with less than 30 watts final plate input, would multiply the number of contacts by 13.5

Typical of the many groups participating in this year's Twelfth Annual Amateur Field Day, 15 members of the "Polecats Emergency Group" (of Hamfsters Radio Club) operated in a prairie located on the South Side of Chicago. This group, participating each year (with the exception of the war years) has operated continuously since 1936.

This year, the group operated in the four transmitter class, with equipment used simultaneously on 80 c.w. or 75 phone, 40 c.w., 20 c.w. and 10 meter phone.

Power for all equipment was taken from a 2.5 kw. gasoline driven generator, with other units available for standby emergency use. However, it was not necessary to use the standby

*(Continued on page 171)*

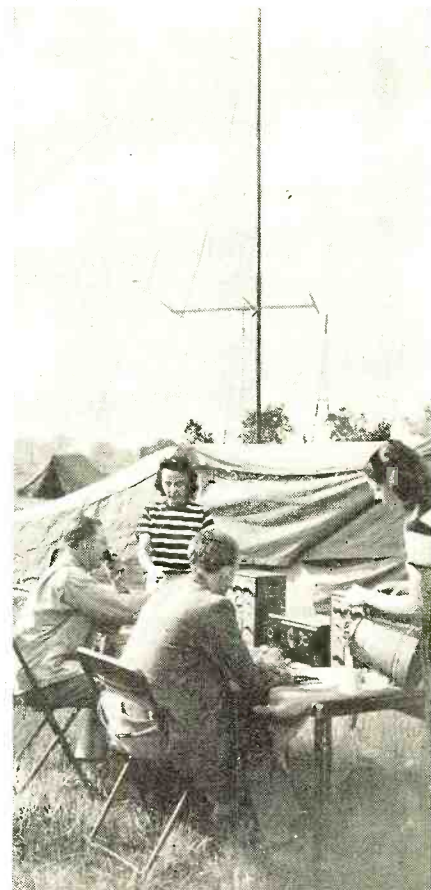

W9FIB and W9JU operate the TBS-50 transmitter on 10 and 20 while Eleanor Hitzel and W9JU's XYL serve up the refreshments.

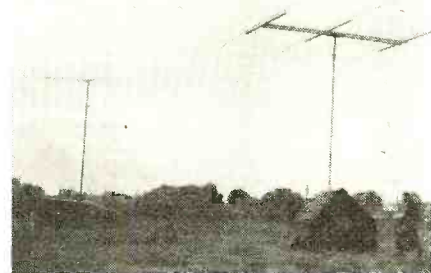

Three-element beams for ten and twenty meter bands helped increase the score.

General view of the setup with the forty meter tent in the foreground. Twenty meter beam may be seen at center.



"Polecat" Joe Haenle, W9FIB, checks an operating position load from the main power distribution panel setup.

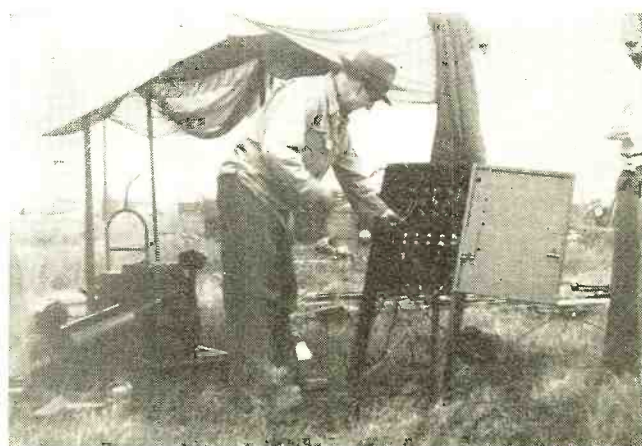

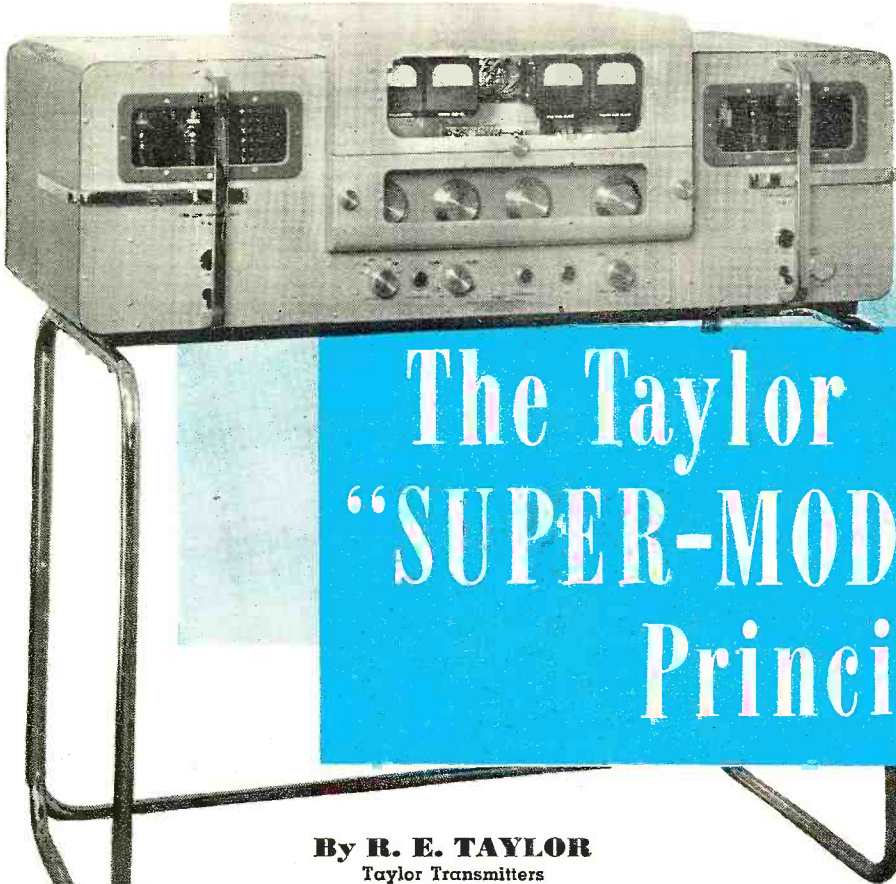

Front view of Taylor Type 900-A transmitter incorporating the new "super-modulation" principle.

# The Taylor "SUPER-MODULATION" Principle

By **R. E. TAYLOR**  
Taylor Transmitters

***New method of radio signaling  
allows greater over-all efficiency with  
compressed carrier and emphasized sideband operation.***

**S**UPER-MODULATION, a new method of radio signaling, was discovered some years past by the author, but its development for general application was delayed by the war. Several hundred broadcast transmitters were built for the Armed Forces using the method.

After several years' delay in presenting this new method to the industry, development has brought the practical application at a time when an improvement is seriously needed in the amateur and other phases of communication service. Many experimental transmitters have since been constructed, using this new system. One of the latest, Type 900-A, a 1 kw. unit, is in service by W6GT, and its operation has been watched by many with considerable interest.

Circumventing previous sideband power restrictions, and applying heretofore unknown principles, the super-modulation use of emphasized sidebands and semi-suppressed carrier transmission provides far greater signaling efficiency than was previously considered feasible.

With more than four times the true sideband power at full modulation, and one-half or less the bandwidth re-

quired in conventional practice, transmission efficiency is about equal that claimed by some for single sideband operation, and in some operational respects is superior to single sideband.

Fifteen to twenty times or more peak power output at full modulation with a bandwidth of two or three kc. each side of carrier and no spread or splatter, is possible. Conventional systems are limited to four times or less peak power. Effectively, this is a sideband or modulation power output increase of from 6 db. upward with no increase in power input to the carrier production equipment.

In semi-suppression or compression of the carrier power under full modulation, when the sideband power is driven upward to high level output, the carrier is reduced at the same time, to allow room for additional sideband power. This also allows the reduction of the heterodyne or interference level at the receiver end. The reduction in the noise level is also allowed at the receiver when receiving a super-modulated signal, due to the compressed carrier and narrow bandwidth. Greater signal voltage out of a standard receiver linear detector results in 6 db. or more gain over a conventional sig-

nal, without modifications. The first difference that will be noted is that the signal is so sharp that it is hard for those used to the conventional broad signals to find. However, when tuned, the signal is louder than anything on the band.

At the receiver end, the super-modulated signal sounds unusually loud. In many cases when the b.f.o. is turned on, the carrier heterodyne is barely audible, and in many instances possible interfering heterodynes from other nearby signals are not heard at all.

Far better speech quality is provided than in most conventional amateur transmitters, as the system reproduces the speech in true color without the necessity for limiters or clippers.

Reception of a super-modulated signal from a 900-A transmitter, in many cases, is not bothered by a strong signal 2 or 3 kc. away in the band. Two 1 kw. 900-A super-modulated transmitters were operated under tests about 2½ kc. apart in the band, using full modulation for maximum sideband power production, with the "S" meter on the receiver several miles away "pinned" by both signals. Either transmitter could be tuned in as desired, without interference from the other. Tuning between the two super-modulated signals resulted in the heterodyne being audible but with the sidebands of the two signals beating together producing a typical "monkey chatter" interference. By tuning 1 kc. each side of center between the two signals either could be readily copied with little interference from the other.

This modulation system has the following advantages:

1. Shows considerable reduction in BCI. Many cases of BCI have been cured by use of super-modulation because of the lack of "buck shot" and splatter.

2. Provides more than double the over-all operating efficiency of conventional systems with far less complicated tuning and adjustment.

3. The audio power in the 1 kw. amateur transmitter is only about 8 watts.

4. Provides far greater plate efficiency than conventional practice.

5. The power amplifier and positive modulator tubes, being audio pulsed for operation, allow greater power input and output. This feature is not new to the radar people as plate dissipation over a period of time for power output can be engineered and used to advantage.

6. More db. of talk-power per size and weight as well as more power input than any other conventional system is offered.

7. About the same power distribution capabilities under full modulation, with respect to sideband power and carrier, as wide-band FM with 30 kc. total deviation for 15 kc. audio frequency response.

8. Provides a substantial effect in reducing the noise level of a conventional receiver for this type of operation.

Sideband power alone, irrespective of how it is generated, is that part of a transmitted radio telephone carrier wave which conveys the intelligence to the receiver at the distant point in communications or amateur radio. The undesirable carrier is one of the greatest contributors to the noise and interference in most receivers.

Thus, the greater the true sideband power produced by the transmitter, the stronger the received signal with less interference. If the sideband power is a true reproduction of the modulation, the bandwidth required is about one-half that necessary with usual high modulation percentages with their attendant distortion, phase shift, and splatter. Further, if the carrier can be reduced, we find a correspondingly lowered noise and interference level in the receiver. Theory shows that a true  $2\frac{1}{2}$  kc. modulation frequency produces sidebands  $2\frac{1}{2}$  kc. removed from the carrier. In many transmitters the harmonic and distortion produce sidebands 5 to 10 kc. removed from the carrier.

Therefore, if we utilize only significant and basic sideband components, by means of appropriate high efficiency production or modulation methods, we wind up with quite a reduction in bandwidth or about  $2\frac{1}{2}$  kc. each side of carrier frequency, with far greater range of communication because of the increased sideband power, or talk power of the transmitter.

When we examine conventional transmitter and receiver practice, we

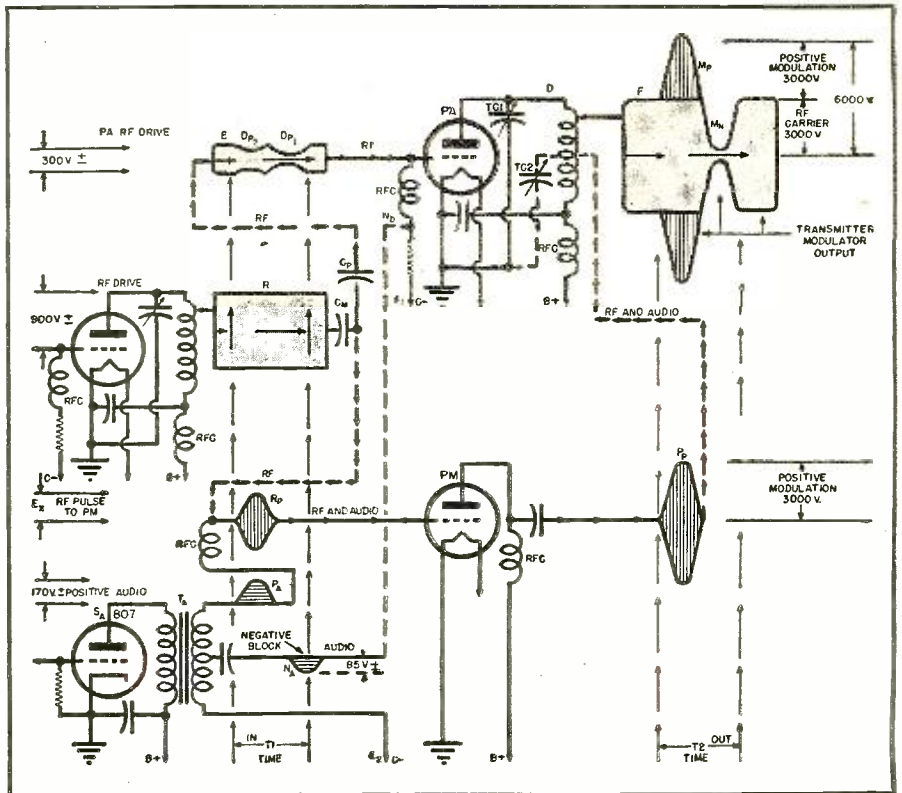

Fig. 1. Operational example of the "super-modulation" system.

find that the radio transmitter as normally operated along with the receiver has a very low intelligence transmission efficiency. Hereafter we shall refer to this as ITE. In other words, ITE represents the true sideband or talk power in one sideband produced by the transmitter.

The broad signal, and limited communication range, of many transmitters using conventional modulation, is often caused by sideband power limitations.

The basic functioning of this new system is shown in Figs. 1 and 2 with the simplified schematic diagram at Fig. 3. Fig. 1 at D represents a conventional power amplifier capable of about 900 watts input, adjusted for maximum carrier power output of about 700 watts. Proper tuning, matching, and loading is assumed and

correct values of bias, screen, and d.c. plate voltage for the maximum efficiency is provided. This output tube is indicated in Figs. 1 and 3 as PA. In Fig. 1, the r.f. drive power at E of about 300 volts is supplied to the grid of this tube from the buffer stage through capacity  $C_p$ . The output r.f. voltage shown at F is about 3000 volts or the maximum that may be developed by tube PA within the limits of its input capability and efficiency.

The plate current pulse of this tube is shown by  $PL_1$  in Fig. 2A operating from base line 1 during the time TP.

Referring again to Fig. 1, when modulation or intelligence is applied to this r.f. carrier output at F for the sideband power production, the 3000 volts of carrier is increased to 6000 volts or more for the positive or upward modulation. This same r.f. car-

Fig. 2. Related plate current pulses in new signaling system.

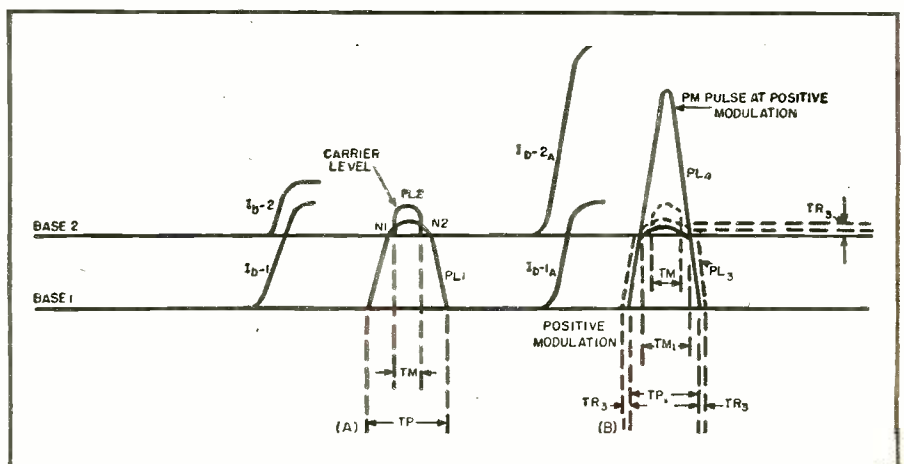

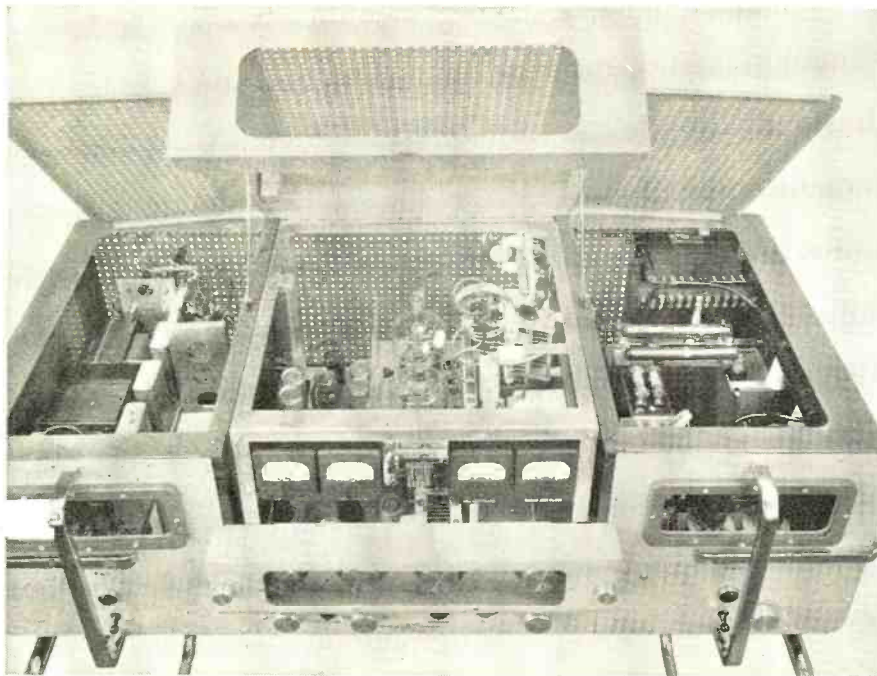

Top view of the Type 900-A transmitter which incorporates "super-modulation" system.

rier of 3000 volts is reduced to almost zero for the negative one-half modulation cycle. These two points are shown as  $M_p$  and  $M_n$  respectively.

Common past practice has been to have the increase and decrease of the carrier controlled and timed so that it follows the waveform of the speech or intelligence applied, with the upward increase at  $M_p$  of equal amplitude and duration to that of the negative modulation  $M_n$ .

In Fig. 1, arrangement is made for a second tube of about the same power input capacity as the power amplifier

tube  $PA$ . This is shown as  $PM$ , or the positive modulator. A second output tank condenser  $TC_2$  is added for separate flywheel action of the second tube  $PM$ . The output of  $PM$  is connected about half way up the output tank inductor, at that point where the second tank condenser  $TC_2$  is connected.

The tank inductance is now slightly reduced to compensate for the added capacity of  $TC_2$ , with both condensers  $TC_1$  and  $TC_2$  ganged to one control. These condensers are of approximately equal capacity.

Fig. 3. Simplified schematic of Taylor system of "super-modulation."

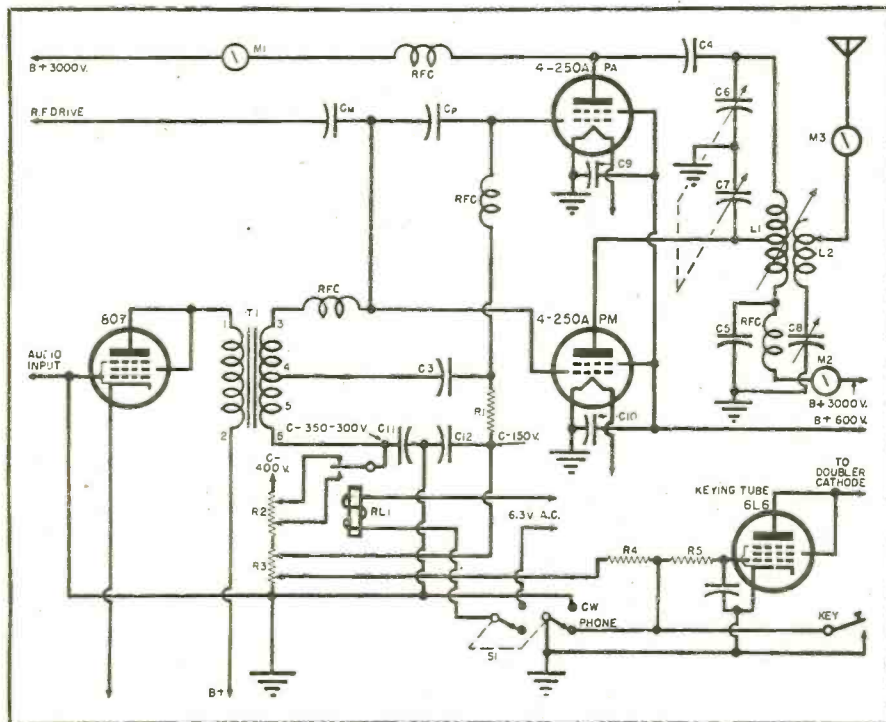

Tuning is the same as before with the dual tank condenser adjusted for minimum dip of the power amplifier tube  $PA$  plate current. Tube  $PM$  although attached to the output tank circuit, contributes almost no carrier under no-modulation conditions. This is shown at  $PL_2$  in Fig. 2A above base line 2 during time  $TM$ . This low output is due to the high bias at  $E_2$  in Fig. 1, and the low r.f. drive from the buffer reservoir, through the coupling capacity  $C_m$ .

With the positive one-half cycle of modulation, tube  $PM$  conducts. Operation is at a high degree of efficiency and with a very small angle of plate current flow, as shown by the plate current pulse  $PL_1$  in Fig. 2B. In Fig. 1 is shown, over period of time  $T_2$ , the additional r.f. power of about 3000 volts at  $P_p$  supplied from tube  $PM$ . This is applied to the output tank circuit, and added to the carrier power present from tube  $PA$ , permitting the positive modulation shown at  $M_p$ , above the unmodulated carrier level  $F$ .

$M_p$  is then a reproduction in waveform of the r.f. drive pulse  $R_p$  from the r.f. reservoir  $R$ , driving tube  $PM$  up the desired power output during the required time.

Triggering control and amplitude of the r.f. drive pulse  $R_p$ , as well as the waveform of the pulse, is effected by the positive one-half cycle of audio shown at  $P_a$ , generated by the audio stage at  $S_a$ , and separated from the negative one-half cycle of audio at the secondary of transformer  $T_a$ . This positive one-half cycle of audio at  $P_a$  opens the bias gate from the r.f. reservoir  $R$  during the required time shown at " $T_1$  IN" and corresponds to " $T_2$  OUT." During this period positive modulation of the carrier at  $M_p$  is developed by power from tube  $PM$ .

This is applied directly to and is additive with the carrier power already present in the output tank circuit. There is no increased plate input to tube  $PA$  during this interval. By allowing operation of the tube  $PM$  only during the positive modulation one-half cycle, a considerable saving in over-all input is permitted. In plate modulation this same high power modulation energy is used to develop the negative modulation of the carrier at a considerable waste of power.

During the function of positive modulation, the average power amplifier efficiency with respect to carrier, is caused to increase a small degree over that of carrier level. Power input during this period, to the power amplifier tube  $PA$ , is reduced slightly as shown by  $TR_2$  of Fig. 2. The normal carrier power level is maintained.

As the plate current pulse of tube  $PM$  is arranged to effectively extend the plate current pulse of the tube  $PA$  for positive modulation, we have an over-all pulse of two times or more the amplitude of that of  $PA$  at carrier level. This is shown in Fig. 2A.

During this period part of the carrier  
(Continued on page 96)

# EFFICIENT SERVICING

By J. E. CUNNINGHAM

**T**HE wartime days when radio service facilities were taxed far beyond their capacity have passed and the radio serviceman is once more faced with ever increasing competition. However, the ultimate objective of the serviceman has not changed. As a serviceman, you must show a profit, whether you own your own shop or work for someone else.

During the war many servicemen gave up their business-like policies. Many discontinued the service guarantee entirely. Still others grew negligent in such things as courtesy, neatness, and other things that make satisfied customers.

The good will of a satisfied customer is by far the most valuable type of advertising any enterprise can have. Set owners put more stock in what their neighbors say about you than in all the advertising you put out. You can have the biggest store in town with the most impressive window displays, but the set owner won't go near you if he feels that you didn't deal fairly with one of his friends.

The customer understands little or nothing about the electronic principles on which his set operates, but he does know what it looks like. If, when you return his set, it is dirty and covered with dust, he will think of you as a rather sloppy worker. On the other hand, if, when he gets his set, the cabinet is well polished, the dial lamp in good order, and any missing knobs replaced, he will have the feeling that you have devoted a lot of time to the job and he will be in a better disposition to judge the performance of the set.

While he is unable to either see or understand the work that has been done beneath the chassis, he can and usually does see the work that has been done above the chassis. The function of the parts which you have put in may be Greek to him, but the appearance of the job is obvious. It takes only a little more time to mount parts neatly. If the i.f. transformer or output transformer which you have put in is smaller than the original was, new holes should be drilled and the unit mounted neatly rather than fastened in with one bolt at a rakish angle. Parts that have been fastened on with tape present a terribly slipshod appearance.

Another influencing factor in the appearance of the repaired set is the dial glass. Ordinary window cleaner

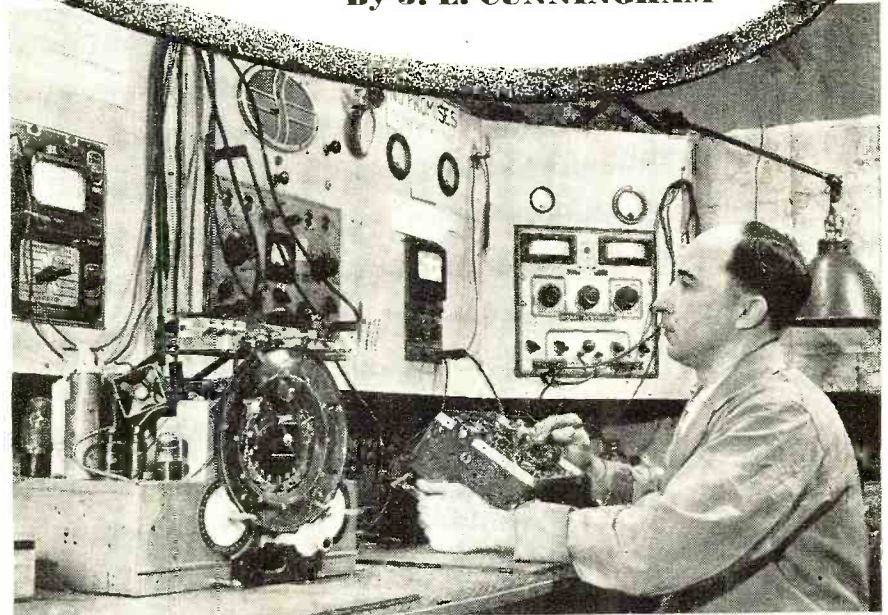

This orderly service bench at the Leonard Ross Radio Company in Detroit inspires customer confidence. Leonard Ross checks a radio receiver chassis.

## ***Your reputation as a radio serviceman is built on little things—here is a timely check list.***

will make a world of difference in the dial glasses that haven't been cleaned since the day the set was sold. If the glass is broken, replace it. The cost is small and the reward is great. It is true that sometimes the appearance of a set is bad because replacements for broken or defaced dial glasses or faces are not available. In this case, the fact should be brought to the customer's attention. He will realize that at least you tried to do everything you could to improve his radio.

The cabinet itself, whether wooden or plastic, must look presentable. It may not be very much of a piece of furniture, but the customer must have liked it at one time or he wouldn't have bought it. A cabinet refinishing kit can be had at most radio supply houses for a few dollars. With these kits, it is surprising what a change can be made in the looks of a set in a few minutes' time. And, of course, the cabinet must be polished. This is the most rewarding of all, especially with women customers. Women spend a great deal of their lives cleaning and polishing things and they can't understand how a man can call a ra-

dio, or anything else for that matter, in good condition until it has been cleaned. They are often afraid to clean in back of the radio for fear of damaging it and they depend on the radio serviceman to do this for them.

Nothing can be done with plastic cabinets that are completely smashed except to replace them, if a replacement is available, but when the cabinet is only cracked, a little cement and gauze can work wonders with it.

Equally as important as the appearance of the set is its performance. The customer is not fooled when an inferior job is passed off on him. His friends have radios that he will hear and if they sound better than his own, he will blame you for it. During the war, it was possible to pass off almost any kind of work because few, if any, shops were able to get the necessary parts or help to do real quality work. Things are different now. If you don't do a good job on a set, someone else will.

Not only must the set play well, but it must *keep* playing. Re-calls or kick-backs are the worst possible kind of

*(Continued on page 126)*

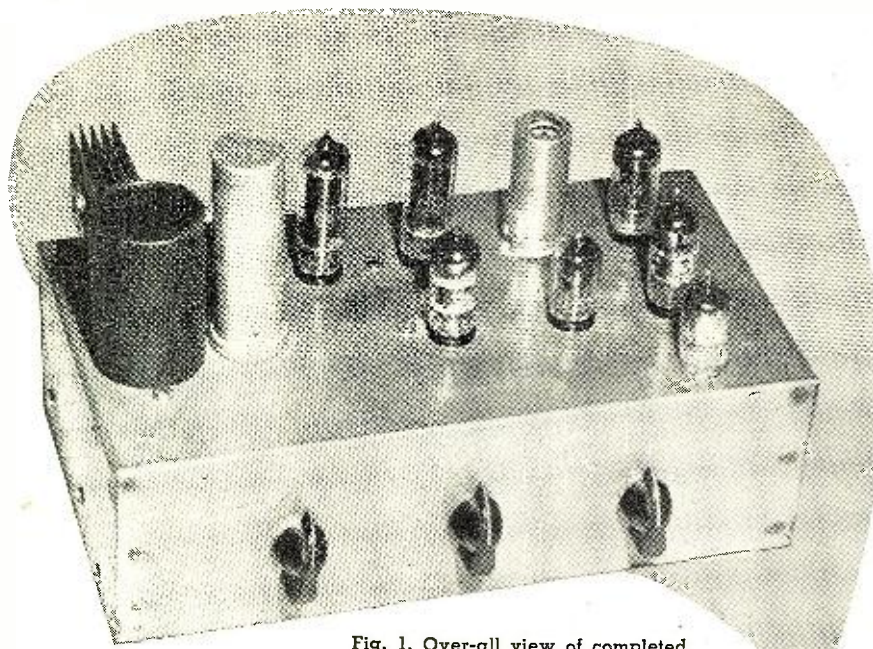

Fig. 1. Over-all view of completed amplifier. Speaker is mounted separately in a bass reflex cabinet.

# A Miniature Tube High Fidelity Amplifier

By  
**WM. BOYER & EMORY TOOPS**

*Featuring—both phono and mike inputs, compressor, expander, and phono pickup equalizing network—all in a single package with 4 watts hum-free output.*

THE recent rise in public appreciation of high fidelity sound reproduction has caused most conventional audio amplifiers used for record reproduction to become outmoded. For natural reproduction of music, an amplifier must meet several requirements.

First, it must possess a flat frequency response over a wide range. For high fidelity reproduction, this response should be essentially flat from about 40 or 50 cycles to over 10,000 cycles. To take advantage of the full frequency range of FM the upper frequency limit should be extended to 12,000 or 15,000 cycles.

Second, since in broadcasting or recording music, volume compression (that is, the reduction of the ratio of intensities of loud passages to soft

passages) is employed, a compensating degree of volume expansion is necessary to restore the intensity levels to their original balance. The use of volume expansion results in far more natural sounding music, and lends depth and life to a recording.

Finally, an amplifier should have very little distortion if it is to reproduce faithfully the signal impressed upon it. The authors believe that the amplifier to be described incorporates all of these features plus several more which increase its usefulness.

One or more stages of pre-amplification are necessary if the newer low-level pickups, now available at modest cost, are to be accommodated. In addition to volume expansion, volume compression is provided, since it is useful in some audio applications and its in-

clusion requires but minor circuit alterations.

The inclusion of these refinements in a standard amplifier, however, usually results in higher cost and larger physical size. Several somewhat critical adjustments are also necessary before the amplifier operates properly. By using the readily available miniature tubes, both cost and physical size can be reduced. The circuit to be described has few adjustments. Construction is straightforward and if done in the manner prescribed no difficulty should be encountered.

The response curve of this amplifier is shown in Fig. 4. It is substantially flat from 80 to 10,000 c.p.s. which more than meets the requirements for high fidelity reproduction. The dotted line shows the response with a 1000  $\mu\text{fd}$ . mica condenser connected across the plates of the 50B5's. This condenser may be used by those not desiring the extreme high frequency response.

The choice of tubes was governed by availability and cost. Since the pre-amplifier heaters should be operated on direct current for hum-free operation, a single or dual triode with a 150 milliamper heater is desirable so that heater current may be drawn from the power supply; 6C4's with their 7 pin bases were chosen over the newer 12 volt types using noval 9 pin bases because of their ready availability on the surplus market.

The 9003 was chosen for the expander-compressor stage because of its remote cut-off feature. A 6AG5 was used as the expander-compressor amplifier but a 6AK5 worked equally as well. Both are easily obtainable. For the expander-compressor rectifier, crystal diodes (1N21B's) were first tried but they loaded the 6AG5 so much that the gain of this stage fell to about 2. Substituting a 6AL5 for the crystals gave considerably less loading of the 6AG5 and correspondingly higher control voltage for the 9003. A 6J6 twin-triode is used as a floating paraphase inverter eliminating any phase inverter adjustments. 50B5's were chosen as the power amplifiers for two reasons; their use in new a.c. receivers has made them available at low cost from the usual radio parts jobbers and their heaters in series with the 6C4 heaters eliminated the need for a series dropping resistor. The push-pull 50B5's provide nearly 4 watts of class A output at very low distortion, which is more than sufficient to drive a 12 inch speaker at good listening level.

A conventional expander-compressor circuit, consisting of 9003, 6AG5 and 6AL5, provides both expansion and compression by means of a single control. The principle of operation is similar to that of a.v.c. in a superhet receiver. In the latter applications a d.c. voltage developed across the diode load circuit of the detector is added to the fixed bias of the r.f. and i.f. tubes. However, in this circuit the audio voltage is applied to both the

**RADIO & TELEVISION NEWS**

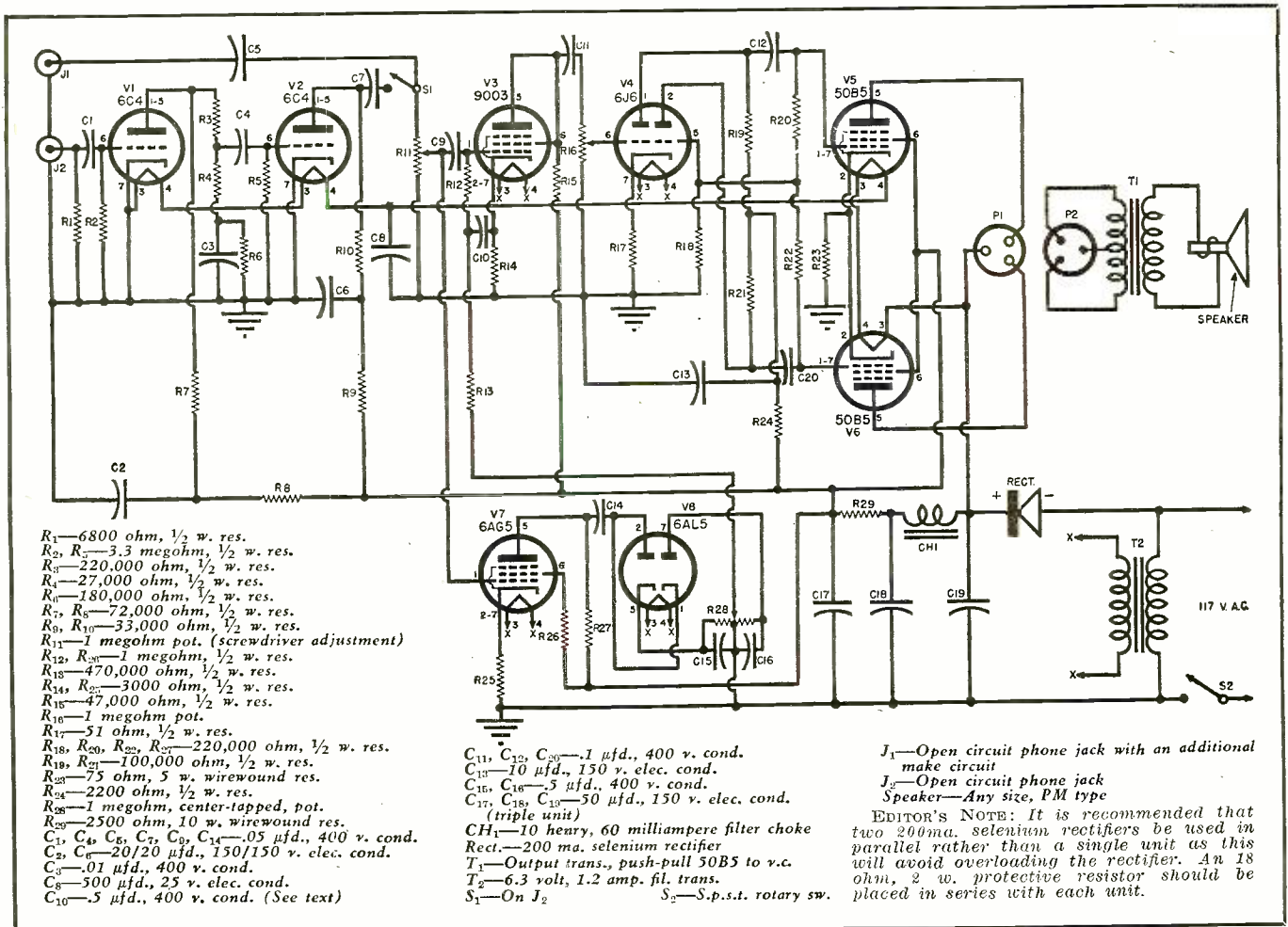

Fig. 2. Complete schematic diagram. Tubes 9003, 6AG5, and 6AL5 make up expander and compressor circuit.

9003 and the 6AG5. The 6AG5 amplifies this voltage while the 6AL5 rectifies it. The rectified d.c. voltage appearing across the one megohm center tapped potentiometer will vary according to the audio voltage that reaches the grid of the 6AG5.

Since the center tap of the potentiometer is grounded, the two ends will be of opposite polarity with respect to ground. Hence if positive voltage is added to the fixed negative bias of the 9003 an increase in amplification or expansion results while the addition of negative bias to the 9003 provides decreased amplification or compression. Compression is normally used only in recording, but it is sometimes desirable for special effects.

The rate of rise and fall of either expansion or compression is controlled by the time constant of the circuit which includes condenser C<sub>10</sub>. A low time constant results in a rapid rise and fall of control voltage, while a high time constant gives a very gradual rise and fall. The time constant is most easily adjusted by varying the value of C<sub>10</sub>. For the reproduction of classical music a fairly large time constant is desirable, otherwise expansion will be too rapid. A value for C<sub>10</sub> of from 0.5 to 1.0 μfd. may be used. For use with popular music a lower value of C<sub>10</sub> will be satisfactory. The

constructor should try several values in this range until one is found that suits his individual taste as to rate of expansion and type of music.

The preamplifier is of the type recommended for use with the new General Electric "Variable Reluctance Pickup" to provide equalization and preamplification. This General Electric pickup is rated at 11 millivolts

output but the preamplifier works equally well with pickups with outputs as low as 2.5 millivolts. For other pickups, however, the equalization may be changed to suit the listener. The value of R<sub>1</sub> controls the high frequency response. A lower value will lower the high frequency response, while a higher value will in-

(Continued on page 157)

Fig. 3. Underchassis view shows placement of miscellaneous components.

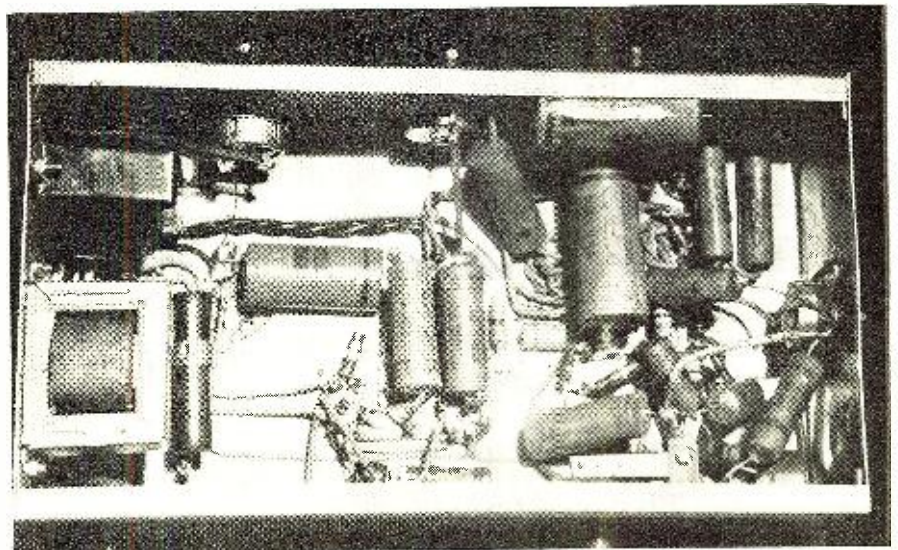

# The RECORDING and REPRODUCTION of SOUND

By **OLIVER READ**  
Editor, RADIO & TELEVISION NEWS

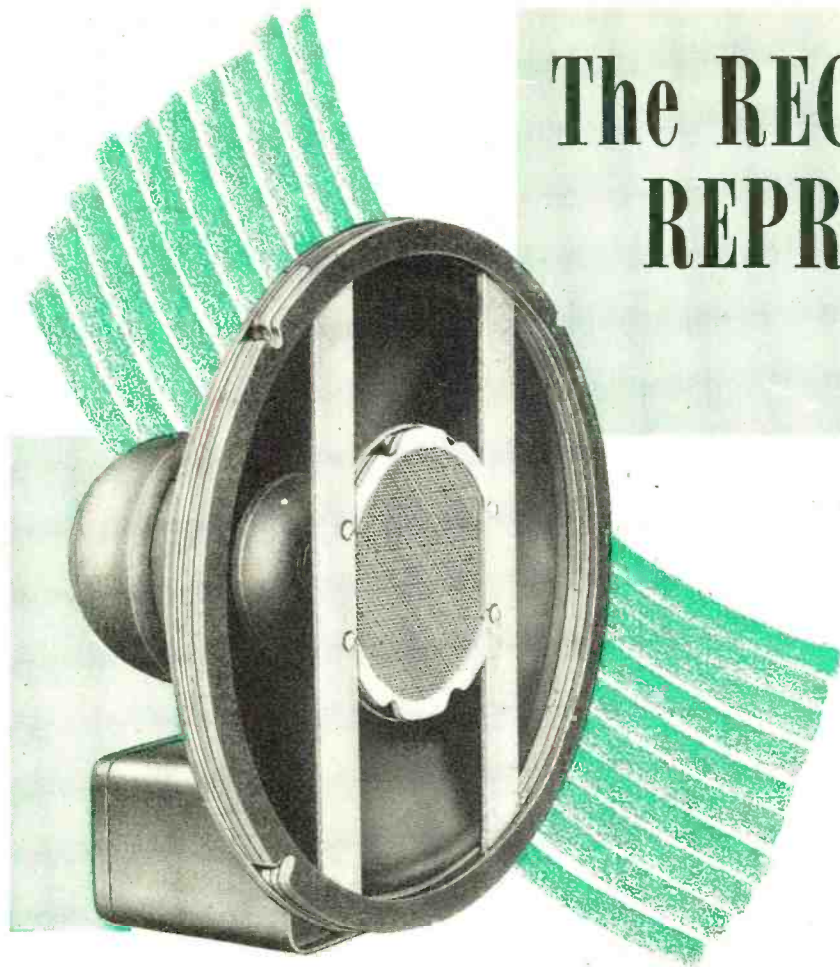

One of the new Cinaudagraph coaxial speaker units.

## Part 19. Design data covering series and parallel connected filter type networks and the constant resistance networks for use with audio amplifiers.

**M**ANY audio systems make use of separate high-frequency and low-frequency loudspeakers. In order to obtain maximum efficiency from this dual reproducing arrangement, *dividing networks* are connected between the amplifier output transformer and the voice coils of the tweeter (high-frequency speaker) and woofer (low-frequency speaker). These networks separate the frequency components in the amplifier output voltage into two bands, so that only frequencies above a certain *crossover frequency* are transmitted to the tweeter, and only those below this crossover frequency are transmitted to the woofer. Each speaker thus operates only at those frequencies at which it is most efficient and faithful.

The crossover frequency may be selected at will, but most commercially available dividing networks operate at crossover frequencies of 400 or 800 cycles. The basic facts concerning

practical dividing networks may be summed up in the following brief comments:

(1) Each such network comprises a low-pass and high-pass filter with their input circuits connected either in series or in parallel. The output circuit of the high-pass filter section feeds the tweeter; that of the low-pass filter, the woofer.

(2) At the crossover frequency, the high- and low-frequency power outputs are equal.

(3) With respect to the attenuation

Fig. 1. Method for inserting dividing network between secondary of amplifier output transformer and loudspeaker voice coils.

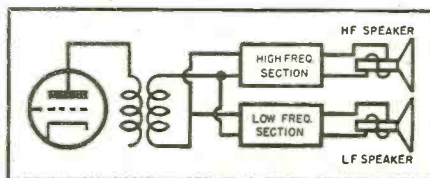

at the crossover frequency, the dividing network should provide 12 db. minimum attenuation one octave from the crossover frequency.

(4) The *constant-resistance* type of dividing network is a specific form which, when terminated in the proper resistance load, will offer a constant input resistance over a frequency band. The constant-resistance type network is convenient in some instances, since each of its capacitive components are identical in value, as are each of its inductive components.

Circuit diagrams of dividing networks are given in Figs. 2 and 3, together with the formulas for obtaining the values of their capacitive and inductive elements. The arrangements shown in Fig. 2 are the conventional series- and parallel-connected filter-type networks. Those given in Fig. 3 are constant-resistance networks. In the latter groups, two of the circuits (A and C) will provide only about 6 db. attenuation at 1 octave from the crossover frequency, and should be employed only in those specific cases where this low attenuation may be tolerated.

### Position of Network in Amplifier

The band-separating action of the dividing network might be obtained at several points in a conventional audio amplifier. In standard practice however, the dividing network is almost always connected between the secondary winding of the amplifier output transformer and the loudspeaker voice coils, as shown in Fig. 1. In this way, one output amplifier stage is made to serve both loudspeakers.

Each network section must carry the full power delivered to the loudspeaker which it supplies. Network components accordingly must be capable of handling these power levels safely. At the same time, the resistance of the inductors must be of the lowest possible value, consistent with required inductance, in order to minimize insertion losses.



The impedances out of, and into which the practical dividing network operates are identical with the rated voice coil impedance of the speakers. Thus the  $R_0$  value that appears in the formulas.

### Use of Tables

All component values for dividing networks may be calculated by means of the formulas given in Figs. 2 and 3. However, Tables 1 and 2, which list these values calculated with sufficient accuracy for critical applications, are included herein for the reader's convenience.

Tables 1 and 2 list all condenser and inductor values required, respectively, in conventional and constant-resistance type dividing networks. These tables are based upon an  $R_0$  value of 10 ohms and an  $m$  of 0.6. All capacitance values are given in microfarads and all inductance values in millihenries, for common crossover frequencies every 50 cycles from 100 to 1000 cycles.

When working with systems in which  $R_0 = 10$ , all  $C$  and  $L$  values may be read in the corresponding frequency column directly from Table 1 for conventional networks, or from Table 2 for the constant-resistance type. For  $R_0$  values other than 10, the chart values may be operated upon to yield values required for the new impedance, thus, for a value ( $R_x$ ) other than  $R_0$  (10 ohms), multiply all  $L$  values corresponding the desired crossover frequency by  $R_x/R_0$ , and divide all  $C$  values by this same factor.

As an illustration of the use of the  $R_x/R_0$  factor, consider the following example: A conventional dividing network is required to work between 16 ohms at a crossover frequency of 450 cycles. At 16 ohms,  $R_x/R_0 = 16/10 = 1.6$ . All  $L$  values in the 450 cycle column of Table 1 must be multiplied by 1.6, and all  $C$  values in the same column must be divided by 1.6:

$$\begin{aligned} C_1 &= 70.76/1.6 = 44.22 \mu\text{fd.} \\ C_2 &= 22.11/1.6 = 13.81 \mu\text{fd.} \\ C_3 &= 35.38/1.6 = 22.11 \mu\text{fd.} \\ C_4 &= 17.69/1.6 = 11.05 \mu\text{fd.} \\ C_5 &= 56.61/1.6 = 35.38 \mu\text{fd.} \\ L_1 &= (5.66) 1.6 = 9.056 \text{ mh.} \\ L_2 &= (3.54) 1.6 = 5.664 \text{ mh.} \\ L_3 &= (1.77) 1.6 = 2.832 \text{ mh.} \\ L_4 &= (7.08) 1.6 = 11.328 \text{ mh.} \\ L_5 &= (2.21) 1.6 = 3.536 \text{ mh.} \end{aligned}$$

To find the capacitance and inductance values required at 10 ohms for some crossover frequency ( $f$ ) in cycles-per-second, other than one of the 19 frequencies given in the two charts, first locate the  $C$  and  $L$  values in the "100 cycle" column, then multiply each of these values by  $100/f$ . If a different impedance ( $R_x$ ) as well as a different frequency ( $f$ ) is required, locate both the capacitance and inductance values in the "100 cycle" column of the chart, and multiply the capacitances thus obtained by  $1000/(fR_x)$ , and the inductance by  $(10R_x)/f$ .

As an illustration of the use of these

$f_c =$	100	150	200	250	300	350	400	450	500	550	600	650	700	750	800	850	900	950	1000
$C_1$	318.5	212.30	159.24	127.38	106.16	90.98	79.62	70.76	63.70	57.90	53.08	48.98	45.48	42.46	39.80	37.50	35.38	33.52	31.85
$C_2$	99.47	66.34	49.76	39.81	33.17	28.43	24.88	22.11	19.91	18.09	16.59	15.31	14.21	13.27	12.44	11.72	11.06	10.47	9.95
$C_3$	59.15	106.15	79.62	63.69	53.08	45.49	39.81	35.38	31.85	28.95	26.54	24.49	22.74	21.23	19.90	18.75	17.69	16.76	15.91
$C_4$	79.57	53.07	39.81	31.84	26.54	22.74	19.90	17.69	15.92	14.47	13.27	12.24	11.37	10.61	9.95	9.37	8.84	8.38	7.96
$C_5$	254.64	169.84	127.33	101.90	84.93	72.78	63.69	56.61	50.96	46.32	42.46	39.18	36.38	33.97	31.84	30.00	28.30	26.82	25.46
$L_1$	25.46	16.98	12.74	10.19	8.49	7.28	6.37	5.66	5.10	4.63	4.25	3.92	3.64	3.40	3.18	3.00	2.83	2.68	2.55
$L_2$	15.91	10.61	7.96	6.37	5.31	4.55	3.98	3.54	3.18	2.89	2.65	2.45	2.27	2.12	1.99	1.87	1.77	1.68	1.59
$L_3$	7.96	5.31	3.98	3.18	2.65	2.27	1.99	1.77	1.59	1.45	1.33	1.22	1.14	1.06	0.995	0.937	0.884	0.838	0.796
$L_4$	31.85	21.23	15.92	12.74	10.62	9.09	7.96	7.08	6.37	5.79	5.31	4.90	4.55	4.25	3.98	3.75	3.54	3.35	3.18
$L_5$	9.95	6.63	4.98	3.98	3.32	2.84	2.49	2.21	1.99	1.81	1.66	1.53	1.42	1.33	1.24	1.17	1.11	1.05	0.995
C in $\mu$ fds. L in mh. $m = 0.6$ $R_0 = 10$ ohms $f$ in cycles																			

Table 1. Conventional dividing networks. See Fig. 2 for circuits.

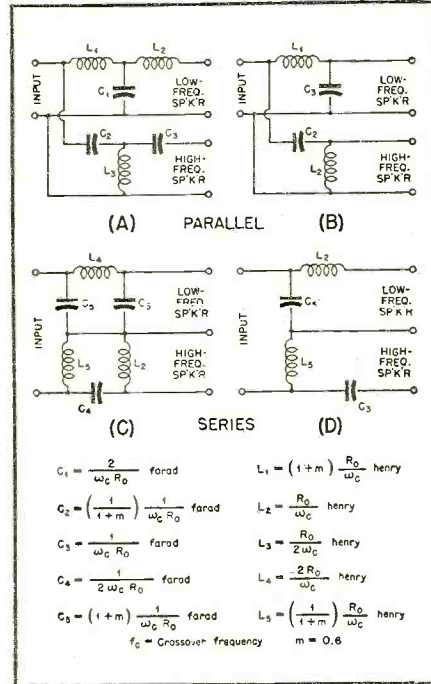

Fig. 2. Conventional series and parallel connected filter type networks along with the formulas for obtaining LC component values.

last two formulas, consider the following example: A constant-resistance dividing network is required to work between 16 ohms. The 100 cycle values (Table 2) will be multiplied thus:

$$\begin{aligned} C_1 &= 159.15 \times 0.125 = 19.89 \mu\text{fd.} \\ C_2 &= 225.04 \times 0.125 = 28.13 \mu\text{fd.} \\ C_3 &= 112.52 \times 0.125 = 14.06 \mu\text{fd.} \\ L_1 &= 15.91 \times 0.32 = 5.09 \text{ mh.} \\ L_2 &= 11.25 \times 0.32 = 3.60 \text{ mh.} \\ L_3 &= 22.50 \times 0.32 = 7.20 \text{ mh.} \end{aligned}$$

$$\begin{aligned} 1000/(fR_x) &= 1000/(500 \times 15) = 0.125 \\ (10R_x)/f &= (10 \times 16)/500 = 0.32 \end{aligned}$$

As with any combination of speakers, attention must be paid to the proper phasing of coaxial units. Both

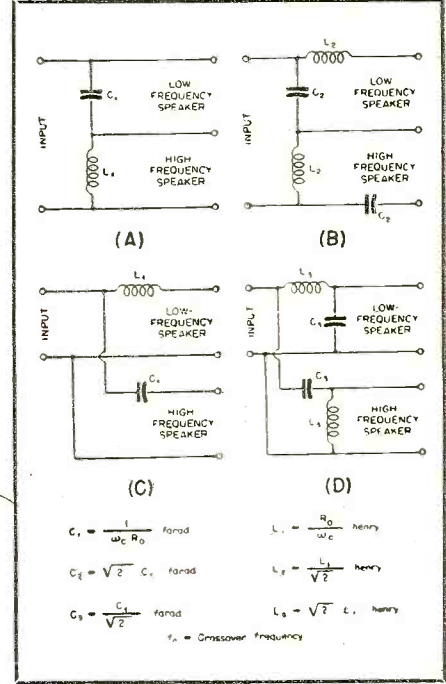

Fig. 3. Four types of constant-resistance networks and associated formulas for computing values. See note in text on A and B.

cones must move in the same direction at the same moment to be properly in phase. Correct polarity may be observed by connecting a battery to the two voice coils momentarily. Both cones should definitely move in the same direction for the same battery polarity.

Correct impedance matching must also be observed for maximum efficiency of dual or coaxial speaker combinations. Specific examples of this impedance matching will be discussed in some detail later in this series.

### REFERENCE

*Aerovox Research Worker*, Vol. 17, No. 10.  
 (To be continued)

Table 2. Constant-resistance dividing networks. See Fig. 3.

$f_c =$	100	150	200	250	300	350	400	450	500	550	600	650	700	750	800	850	900	950	1000
$C_1$	159.15	106.15	79.62	63.69	53.08	45.49	39.81	35.38	31.85	28.95	26.54	24.49	22.74	21.23	19.90	18.75	17.69	16.76	15.91
$C_2$	225.04	150.10	112.58	90.06	75.05	64.32	56.29	50.03	45.03	40.93	37.53	34.63	32.15	30.02	28.14	26.51	25.01	23.69	22.50
$C_3$	112.52	75.05	56.29	45.03	37.52	32.16	28.14	25.01	22.51	20.46	18.76	17.31	16.07	15.01	14.07	13.25	12.50	11.84	11.25
$L_1$	15.91	10.61	7.96	6.37	5.31	4.55	3.98	3.54	3.18	2.89	2.65	2.45	2.27	2.12	1.99	1.87	1.77	1.68	1.59
$L_2$	11.25	7.50	5.63	4.50	3.75	3.22	2.81	2.50	2.25	2.04	1.87	1.73	1.60	1.50	1.41	1.32	1.25	1.19	1.12
$L_3$	22.50	15.00	11.26	9.00	7.50	6.44	5.62	5.00	4.50	4.08	3.74	3.46	3.20	3.00	2.82	2.64	2.50	2.38	2.24
C in $\mu$ fds. L in mh. $R_0 = 10$ ohms $f$ in cycles																			

# Build Your Own COMMUNICATIONS RECEIVER

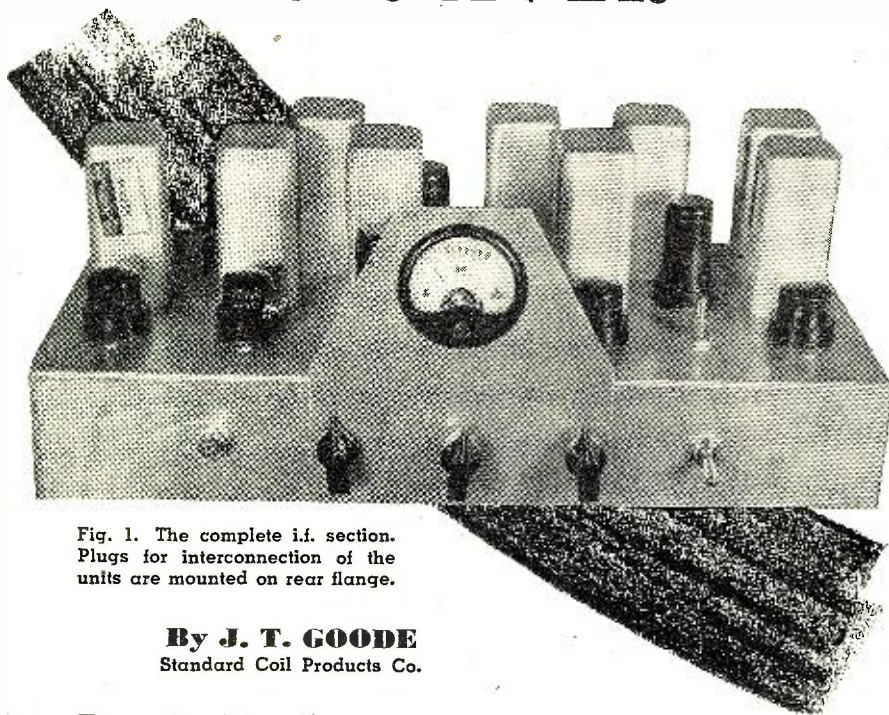

Fig. 1. The complete i.f. section. Plugs for interconnection of the units are mounted on rear flange.

By **J. T. GOODE**  
Standard Coil Products Co.

## Part 2. Details for construction of i.f. channel with three steps of selectivity.

IN THE first article of this series, the requirements of a good communications receiver were set forth along with a detailed discussion on constructing a power supply and the amplifier unit to be used with the completed receiver. This article covers the construction of the intermediate amplifier and detector section of the receiver.

There are many ways of designing i.f. amplifiers and detectors. Each type has its advantages and disadvantages. Regardless of actual design the following features are desirable:

1. Ample gain;
2. Good signal-to-noise ratio;
3. Variable selectivity;
4. Sharp selectivity for communication operation;
5. Low distortion;
6. An a.v.c. switch;
7. B.f.o.;
8. A.n.l.;
9. "R" meter;
10. Narrow-band FM;
11. Mechanical and electrical design such that unit requires a minimum amount of time for construction and test;
12. No regeneration.

The outlined requirements have been designed into the intermediate amplifier and detector to be described.

There are two types of engineering, conservative and production. Both types work toward the same end, a

satisfactory engineering model. Engineering a receiver for production requires maximum results from a minimum number of parts. Many engineering decisions are made in favor of a low cost figure. This can result in lowering the quality of the product.

From an engineering viewpoint, it is far more difficult to design a production model than to simply build a good radio. Bypass condensers are only used where absolute necessity dictates in a production model.

Conservative engineering follows a different line of thinking. This calls for the use of adequate filter networks for each stage so that satisfactory operation is guaranteed.

Tubes are cheap, so there is no necessity for designing some tricky switching assembly simply to save the price of a tube. Some of these trick assemblies cause regeneration due to extended lead length, and regeneration causes more receiver headaches than any other single fault.

Receiver manufacturers spend weeks and sometimes months in engineering, simply to eliminate three or four bypass condensers or resistors without impairing the operation of the

set. By doing this the cost of the completed chassis is reduced a few cents.

From a manufacturing standpoint, this is good business; for the home constructor it is not. The amount of money saved in the over-all cost of a home-built unit will not justify the possible difficulties that might result from such construction.

Production engineering usually demands maximum gain from each amplifier stage. Engineering experience and good test equipment are needed to meet such design requirements. Special coils are usually required. The home constructor may lack both the required engineering experience and the proper test equipment.

Conservative engineering eliminates this difficulty. Do not design equipment that requires maximum gain from each stage. Instead, design so that adequate gain is available without requiring any one stage to operate at peak efficiency. Under such conditions parts become far less critical. Production engineering enjoys no such luxury as this type of design.

The main difference between the two types of engineering is the cost of the parts required to build approximately the same type of radio. From an engineering cost figure, production type engineering is far more expensive. This expense is amortized over the production run, and the cost per unit can be quite low.

### Design

The desirability of having variable selectivity is illustrated by the two graphs shown in Figs. 3 and 6. As selectivity is increased, sideband interference decreases. This feature is desirable for communication reception. Amplitude modulation high frequency response is attenuated as the selectivity is increased, and this feature is undesirable in the broadcast band. Therefore, a receiver to be used for broadcast and communication should have variable selectivity.

The graph in Fig. 3 was made by modulating a signal generator with an audio oscillator and plotting the audio output of the second detector. At 5000 cycles the audio was attenuated 9.5 db. with wide-band i.f., 17 db. with narrow-band, and 24 db. with sharp-band. With high frequency compensation the attenuation was reduced to 3 db. at 5000 cycles. The compensating condenser is  $C_{20}$ .

Some broadcast receivers are down 30 db. at 5000 cycles. This is due to a combination of selectivity attenuation and lack of high frequency response in the audio amplifier.

It is difficult to tell any difference between FM and AM reception with this receiver operating in the wide-band position, listening to the same program coming over two stations, one being FM and the other AM. Such tests have been made using an FM tuner and the same audio amplifier for both FM and AM.

Variable selectivity design is usually

**RADIO & TELEVISION NEWS**

Fig. 2. Schematic diagram for the complete i.f. channel. Power is supplied from the unit described in last month's issue.

Condensers shunting i.f. coils are included in Miller coils.

T<sub>1</sub>, T<sub>2</sub>—Modified Miller #912C1 coil

T<sub>3</sub>, T<sub>4</sub>—Miller #912C2 coil

T<sub>5</sub>, T<sub>6</sub>—Miller #912C3 coil

T<sub>7</sub>, T<sub>8</sub>—Miller #912C4 coil

T<sub>9</sub>, T<sub>10</sub>—Miller #912C4 coil

T<sub>11</sub>—Miller #912C1 coil

S<sub>1</sub>—3-pole, 4-pos. rotary sw.

S<sub>2</sub>—Centradab #1425

S<sub>3</sub>, S<sub>4</sub>—S.p.s.t. toggle sw.

M<sub>1</sub>—Hammarlund "K" meter

R<sub>300</sub>—250,000 ohm pot. (with S<sub>1</sub>)

C<sub>1</sub>, C<sub>2</sub>—10 μfd. mica or ceramic cond.

C<sub>3</sub>, C<sub>4</sub>, C<sub>5</sub>, C<sub>6</sub>, C<sub>7</sub>, C<sub>8</sub>, C<sub>9</sub>, C<sub>10</sub>, C<sub>11</sub>, C<sub>12</sub>, C<sub>13</sub>, C<sub>14</sub>, C<sub>15</sub>, C<sub>16</sub>, C<sub>17</sub>, C<sub>18</sub>, C<sub>19</sub>, C<sub>20</sub>, C<sub>21</sub>, C<sub>22</sub>, C<sub>23</sub>, C<sub>24</sub>, C<sub>25</sub>, C<sub>26</sub>, C<sub>27</sub>, C<sub>28</sub>, C<sub>29</sub>, C<sub>30</sub>, C<sub>31</sub>, C<sub>32</sub>, C<sub>33</sub>, C<sub>34</sub>, C<sub>35</sub>, C<sub>36</sub>, C<sub>37</sub>, C<sub>38</sub>, C<sub>39</sub>, C<sub>40</sub>, C<sub>41</sub>, C<sub>42</sub>, C<sub>43</sub>, C<sub>44</sub>, C<sub>45</sub>, C<sub>46</sub>, C<sub>47</sub>, C<sub>48</sub>, C<sub>49</sub>, C<sub>50</sub>, C<sub>51</sub>, C<sub>52</sub>, C<sub>53</sub>, C<sub>54</sub>, C<sub>55</sub>, C<sub>56</sub>, C<sub>57</sub>, C<sub>58</sub>, C<sub>59</sub>, C<sub>60</sub>, C<sub>61</sub>, C<sub>62</sub>, C<sub>63</sub>, C<sub>64</sub>, C<sub>65</sub>, C<sub>66</sub>, C<sub>67</sub>, C<sub>68</sub>, C<sub>69</sub>, C<sub>70</sub>, C<sub>71</sub>, C<sub>72</sub>, C<sub>73</sub>, C<sub>74</sub>, C<sub>75</sub>, C<sub>76</sub>, C<sub>77</sub>, C<sub>78</sub>, C<sub>79</sub>, C<sub>80</sub>, C<sub>81</sub>, C<sub>82</sub>, C<sub>83</sub>, C<sub>84</sub>, C<sub>85</sub>, C<sub>86</sub>, C<sub>87</sub>, C<sub>88</sub>, C<sub>89</sub>, C<sub>90</sub>, C<sub>91</sub>, C<sub>92</sub>, C<sub>93</sub>, C<sub>94</sub>, C<sub>95</sub>, C<sub>96</sub>, C<sub>97</sub>, C<sub>98</sub>, C<sub>99</sub>, C<sub>100</sub>

C<sub>101</sub>, C<sub>102</sub>, C<sub>103</sub>, C<sub>104</sub>, C<sub>105</sub>, C<sub>106</sub>, C<sub>107</sub>, C<sub>108</sub>, C<sub>109</sub>, C<sub>110</sub>, C<sub>111</sub>, C<sub>112</sub>, C<sub>113</sub>, C<sub>114</sub>, C<sub>115</sub>, C<sub>116</sub>, C<sub>117</sub>, C<sub>118</sub>, C<sub>119</sub>, C<sub>120</sub>, C<sub>121</sub>, C<sub>122</sub>, C<sub>123</sub>, C<sub>124</sub>, C<sub>125</sub>, C<sub>126</sub>, C<sub>127</sub>, C<sub>128</sub>, C<sub>129</sub>, C<sub>130</sub>, C<sub>131</sub>, C<sub>132</sub>, C<sub>133</sub>, C<sub>134</sub>, C<sub>135</sub>, C<sub>136</sub>, C<sub>137</sub>, C<sub>138</sub>, C<sub>139</sub>, C<sub>140</sub>, C<sub>141</sub>, C<sub>142</sub>, C<sub>143</sub>, C<sub>144</sub>, C<sub>145</sub>, C<sub>146</sub>, C<sub>147</sub>, C<sub>148</sub>, C<sub>149</sub>, C<sub>150</sub>, C<sub>151</sub>, C<sub>152</sub>, C<sub>153</sub>, C<sub>154</sub>, C<sub>155</sub>, C<sub>156</sub>, C<sub>157</sub>, C<sub>158</sub>, C<sub>159</sub>, C<sub>160</sub>, C<sub>161</sub>, C<sub>162</sub>, C<sub>163</sub>, C<sub>164</sub>, C<sub>165</sub>, C<sub>166</sub>, C<sub>167</sub>, C<sub>168</sub>, C<sub>169</sub>, C<sub>170</sub>, C<sub>171</sub>, C<sub>172</sub>, C<sub>173</sub>, C<sub>174</sub>, C<sub>175</sub>, C<sub>176</sub>, C<sub>177</sub>, C<sub>178</sub>, C<sub>179</sub>, C<sub>180</sub>, C<sub>181</sub>, C<sub>182</sub>, C<sub>183</sub>, C<sub>184</sub>, C<sub>185</sub>, C<sub>186</sub>, C<sub>187</sub>, C<sub>188</sub>, C<sub>189</sub>, C<sub>190</sub>, C<sub>191</sub>, C<sub>192</sub>, C<sub>193</sub>, C<sub>194</sub>, C<sub>195</sub>, C<sub>196</sub>, C<sub>197</sub>, C<sub>198</sub>, C<sub>199</sub>, C<sub>200</sub>

C<sub>101</sub>—50 μfd. mica or ceramic cond.

C<sub>102</sub>—50 μfd. mica or ceramic cond.

C<sub>103</sub>—500 μfd. mica cond.

C<sub>104</sub>—500 μfd. mica cond.

C<sub>105</sub>—500 μfd. mica cond.

C<sub>106</sub>—500 μfd. mica cond.

C<sub>107</sub>—500 μfd. mica cond.

R<sub>1</sub>, R<sub>2</sub>, R<sub>3</sub>, R<sub>4</sub>, R<sub>5</sub>, R<sub>6</sub>, R<sub>7</sub>, R<sub>8</sub>, R<sub>9</sub>, R<sub>10</sub>, R<sub>11</sub>, R<sub>12</sub>, R<sub>13</sub>, R<sub>14</sub>, R<sub>15</sub>, R<sub>16</sub>, R<sub>17</sub>, R<sub>18</sub>, R<sub>19</sub>, R<sub>20</sub>, R<sub>21</sub>, R<sub>22</sub>, R<sub>23</sub>, R<sub>24</sub>, R<sub>25</sub>, R<sub>26</sub>, R<sub>27</sub>, R<sub>28</sub>, R<sub>29</sub>, R<sub>30</sub>, R<sub>31</sub>, R<sub>32</sub>, R<sub>33</sub>, R<sub>34</sub>, R<sub>35</sub>, R<sub>36</sub>, R<sub>37</sub>, R<sub>38</sub>, R<sub>39</sub>, R<sub>40</sub>, R<sub>41</sub>, R<sub>42</sub>, R<sub>43</sub>, R<sub>44</sub>, R<sub>45</sub>, R<sub>46</sub>, R<sub>47</sub>, R<sub>48</sub>, R<sub>49</sub>, R<sub>50</sub>, R<sub>51</sub>, R<sub>52</sub>, R<sub>53</sub>, R<sub>54</sub>, R<sub>55</sub>, R<sub>56</sub>, R<sub>57</sub>, R<sub>58</sub>, R<sub>59</sub>, R<sub>60</sub>, R<sub>61</sub>, R<sub>62</sub>, R<sub>63</sub>, R<sub>64</sub>, R<sub>65</sub>, R<sub>66</sub>, R<sub>67</sub>, R<sub>68</sub>, R<sub>69</sub>, R<sub>70</sub>, R<sub>71</sub>, R<sub>72</sub>, R<sub>73</sub>, R<sub>74</sub>, R<sub>75</sub>, R<sub>76</sub>, R<sub>77</sub>, R<sub>78</sub>, R<sub>79</sub>, R<sub>80</sub>, R<sub>81</sub>, R<sub>82</sub>, R<sub>83</sub>, R<sub>84</sub>, R<sub>85</sub>, R<sub>86</sub>, R<sub>87</sub>, R<sub>88</sub>, R<sub>89</sub>, R<sub>90</sub>, R<sub>91</sub>, R<sub>92</sub>, R<sub>93</sub>, R<sub>94</sub>, R<sub>95</sub>, R<sub>96</sub>, R<sub>97</sub>, R<sub>98</sub>, R<sub>99</sub>, R<sub>100</sub>

R<sub>101</sub>—80 ohm, 1 w. res.

R<sub>102</sub>—100 ohm, 1 w. res.

R<sub>103</sub>—100 ohm, 1 w. res.

R<sub>104</sub>—100 ohm, 1 w. res.

R<sub>105</sub>—100 ohm, 1 w. res.

R<sub>106</sub>—100 ohm, 1 w. res.

R<sub>107</sub>—100 ohm, 1 w. res.

R<sub>108</sub>—100 ohm, 1 w. res.

R<sub>109</sub>—100 ohm, 1 w. res.

R<sub>110</sub>—100 ohm, 1 w. res.

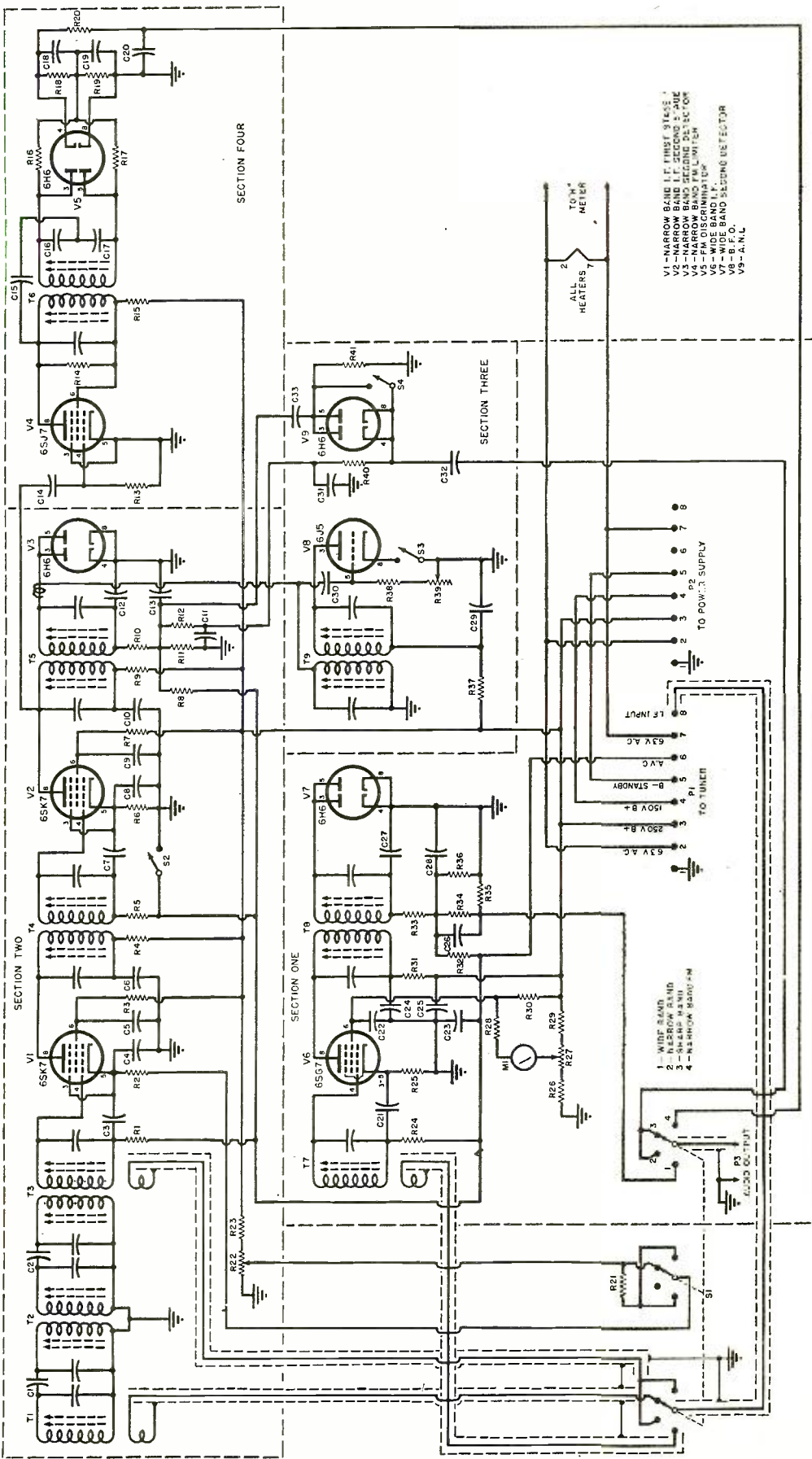

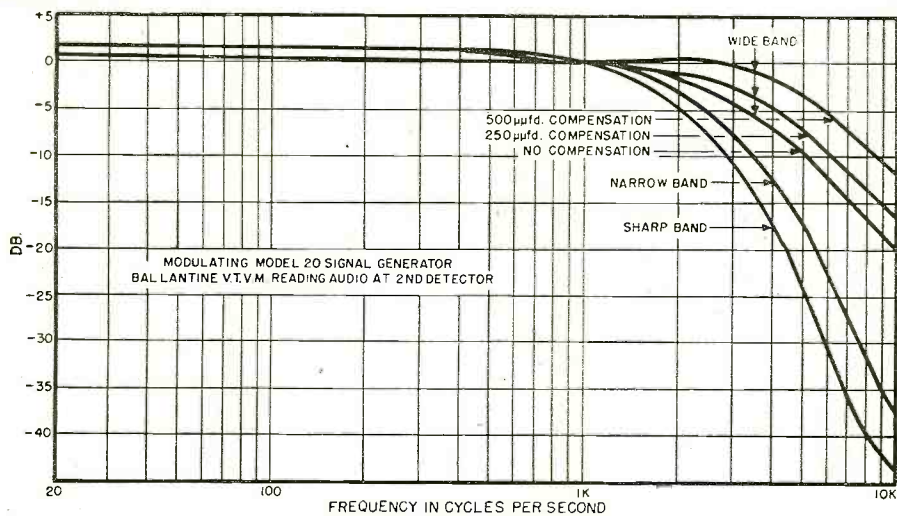

Fig. 3. Over-all response curve of the completed receiver. The attenuation of the higher audio frequencies, due to selectivity, can be seen.

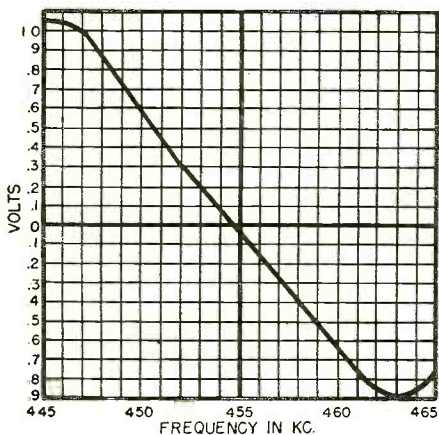

Fig. 4. Discriminator curve obtained by varying the generator frequency.

expensive, difficult to construct, and requires a certain amount of engineering skill. It is normally obtained by changing the coupling between i.f. coils. This can be accomplished either mechanically or electrically. Either way it is complicated. By conservative engineering (adding a few parts) it can be accomplished with comparative ease. By using separate i.f. chan-

nels, each can be designed to operate as required.

Using low impedance input circuits makes switching simple and does not cause regeneration. Leads to the low impedance circuits can be run for a considerable distance without causing any trouble or noticeable loss or gain.

The other graph, Fig. 6, indicates actual selectivity when the i.f. channel is operated as wide-band, narrow-band, and sharp. This set of curves was made by using a signal generator and a v.t.v.m.

At "two times down" the wide-band selectivity is approximately 8 kc. total, narrow-band 4.5 kc., and sharp 3 kc. It is this portion of the curve that affects the audio characteristics of an i.f. channel.

At "one-hundred times down" the wide-band selectivity is approximately 58 kc. total, narrow-band 24 kc., and sharp 13 kc. It is this portion of the curve that determines the ability of the receiver to separate stations.

Two audio tones, one 40 db. below the level of the other, can be heard by the human ear. This means that a signal 40 db. below the level of another is still capable of causing interference.

Fig. 5. Top view of i.f. chassis. Location of important components is given.

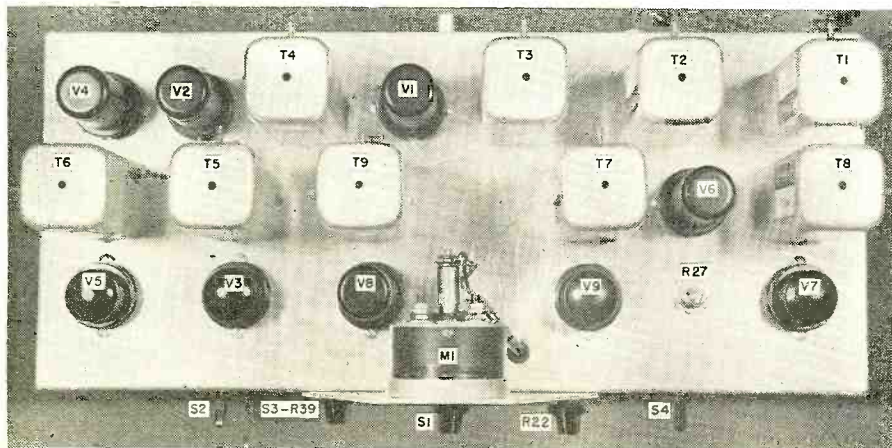

The selectivity of this i.f. channel in the sharp position is narrower than the selectivity of the average communications receiver not including the crystal filter.

Sharp selectivity has some advantages over a crystal filter. It does not introduce distortion but does introduce audio high frequency attenuation. This feature is desirable for phone reception when the bands are crowded. The use of a crystal filter improves selectivity but the i.f. curve does not remain symmetrical, and this introduces distortion.

A crystal filter was not included in the design of the i.f. channel. The selectivity incorporated gives excellent communication reception *as is*. The circuit is straightforward, easy to construct, and stable. If the addition of a crystal filter is required,  $T_2$  should be removed and the crystal filter network inserted at this point.

When the receiver is operated in the broadcast band, the selectivity switch makes an excellent tone control giving audio high frequency attenuation in the narrow and sharp positions.

The narrow-band FM section consists of a 6SJ7 limiter stage and 6H6 discriminator. The linearity of the discriminator is indicated on the graph. The flat portion of the curve is approximately 16 kc. wide. Limiting action takes place at approximately 1 microvolt at the antenna terminals.

Narrow-band selectivity is used for FM reception. The audio output of the discriminator is less than the output of the narrow-band second detector. Any standard 455 kc. i.f. transformer can easily be converted to a discriminator coil. Coil modification information will be discussed later.

Miller slug-tuned coils were used throughout the i.f. channel. These coils are stable and readily available at most wholesale radio stores. Almost any 455 kc. i.f. transformer will be satisfactory. The degree of coupling in each transformer is not critical, due to the large number of tuned circuits. The addition of each tuned circuit adds "Q." Total "Q" (from antenna coil to the second detector) determines the selectivity of the receiver.

Even if all the i.f. transformers were critically coupled, the selectivity of the i.f. channel in the "sharp" position would exceed the selectivity of the average communications receiver, not including a crystal filter. Adjusting for gain variation will be discussed later.

Another standard i.f. transformer is used for the b.f.o. coil  $T_9$ . The purpose of this design was to allow the use of spare i.f. transformers that are sometimes found in so-called "junk boxes."

Connect the blue lead to the plate and the green lead to the grid. If it does not oscillate, reverse either the primary or secondary leads and it will.

The b.f.o. grid leak  $R_{27}$  is variable. Changing this resistance from 47,000 (Continued on page 116)

# Wide Range Speaker Systems

By  
**J. CARLISLE HOADLEY**

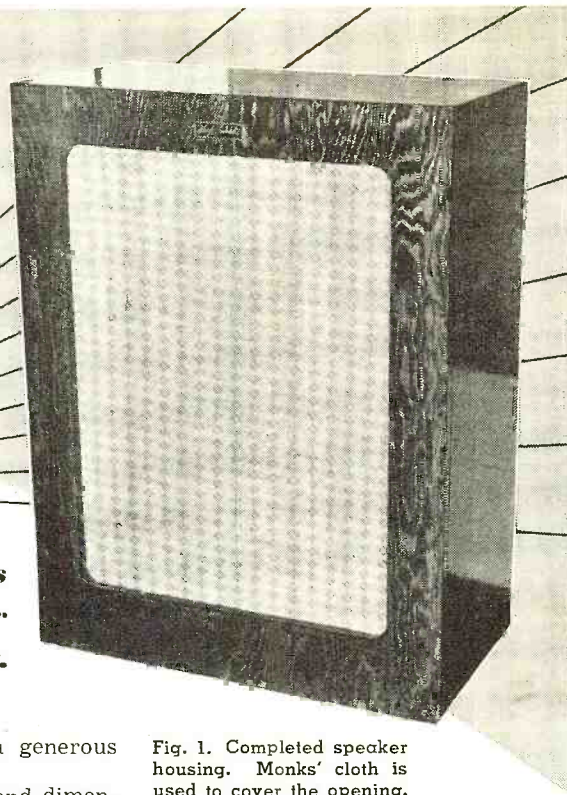

**Construction details for building speaker baffles for use with high-fidelity phono and FM speaker units. Both 12 and 15-inch enclosures are covered.**

NO REALIZE the superb quality that frequency modulation can provide, the use of the best speaker system that can be obtained is desirable. Frequency modulation can provide program material which is not only flat from 30 to 15,000 cycles-per-second, but also has a low inherent hum and noise level and a greater dynamic range.

Most experimenters will prefer to construct their own FM receiver systems because of the monetary saving involved and also for the satisfaction which comes from such an endeavor. Of course, an FM receiver system will include a high fidelity speaker system.

The builder has a wide variety of speakers to choose from. There is a large cost variation between the single-cone, extended-range speaker and the two speaker, wide-range units.

Several manufacturers are offering eight and twelve inch extended-range speakers for FM use. They are so designed as to provide uniform response from some low frequency (depending upon cone diameter) to ten thousand cycles, with very appreciable contribution in the 12,000 to 14,000 cycle range. These speakers range in price from eight to fifteen dollars. Among this group are the *Jensen PM 8-CT*, *PM 12-CT*, and the *Utah FP 820*. These speakers are of the PM type and will provide the purchaser with excellent results at a very low cost.

These speakers should, of course, be installed in a suitable baffle. The bass reflex type enclosure is the best type to use if it is desired to augment the speaker's low frequency response and increase its efficiency. A baffle which is suitable for one 12 inch or two 8 inch speakers is shown in Fig. 3. It cost \$7.50 to build. It is constructed of  $\frac{5}{8}$  inch plywood which is screwed and glued together. The back is remov-

able, being held on with a generous number of wood screws.

Fig. 2A gives the shape and dimensions of all the parts of the enclosure. These parts may be easily sawed by hand, using a regular crosscut saw for the edges and a keyhole saw for the speaker hole.

To start the speaker circular hole, scribe a circle of the proper diameter and then drill a hole which touches the edge of the circle. Insert the keyhole saw and apply elbow grease. The finished parts should be planed, filed, or sanded to smoothness and then assembled.

The new plastic glues are excellent and come in powder form. Merely add water and stir. A few strategically placed nails will eliminate the necessity for using any clamps while the glue sets.

When the unit is dry, it can be painted or finished in the natural

Fig. 1. Completed speaker housing. Monks' cloth is used to cover the opening.

wood. The speaker enclosure in Fig. 1 was given a coat of walnut oil stain and three coats of shellac, sanded lightly between coats. If a light finish is desired a wood filler may be substituted for the oil stain.

The grille cloth should be very porous so as to not attenuate the high frequencies. It is applied to the speaker mounting board with animal glue. It is important that a water type glue is NOT used, as it will soak through the cloth. Monks cloth makes an excellent grille material.

Terminals should be mounted on the back of the cabinet for connection to the speaker.

The completed unit costs less than  
(Continued on page 143)

Fig. 2. (A) Dimensions for building the baffle to house either one 12-inch or two 8-inch speakers. (B) Housing for the 15-inch Jensen coaxial type H speakers.

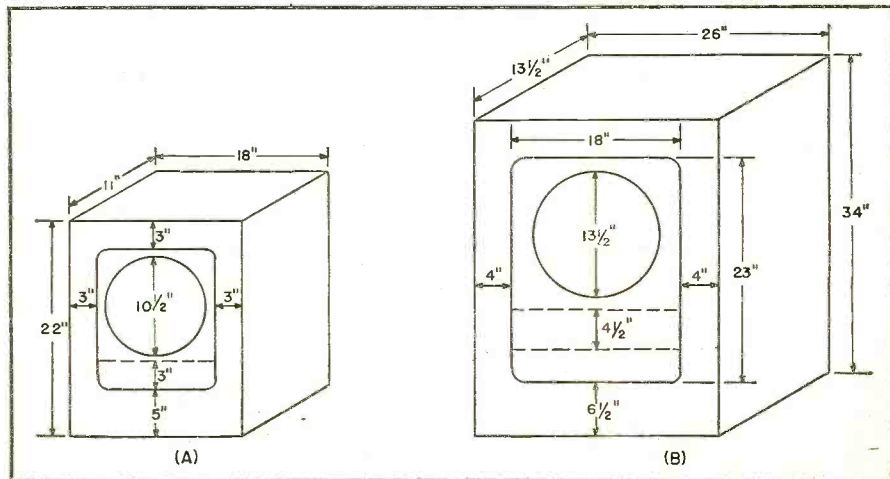

# New TELEVISION POWER SUPPLIES Use Selenium Rectifiers

By

**GEORGE EANNARINO**

Federal Telephone and Radio Corporation

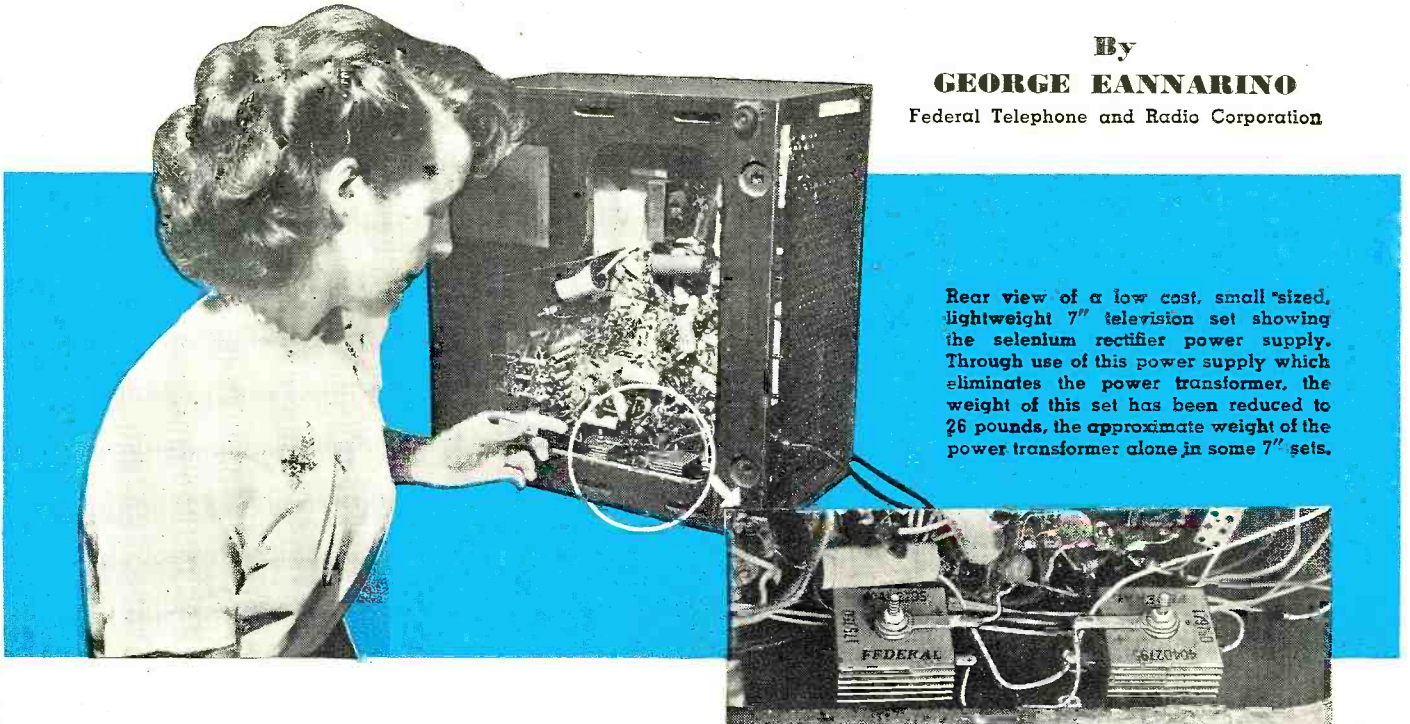

Rear view of a low cost, small sized, lightweight 7" television set showing the selenium rectifier power supply. Through use of this power supply which eliminates the power transformer, the weight of this set has been reduced to 26 pounds, the approximate weight of the power transformer alone in some 7" sets.

## Details on six new power supplies that can be used for mobile, a.c.-d.c., and farm type home television receiving sets.

**EXTREME** flexibility in the design of television receiver power supplies—resulting in lighter, smaller, and lower cost sets,—is now available to manufacturers, engineers, servicemen, and radio amateurs through the use of miniature selenium rectifiers developed by *Federal Telephone and Radio Corporation*. This type of rectifier, which does not have a filament, and is compact and lightweight, permits the utilization of many circuits never before practical with rectifier tubes.

Basically its advantage lies in the fact that the use of an additional rectifier to achieve an improvement in design presents no more of a problem

than does the addition of a resistor or condenser to the circuit. The importance of this factor can best be illustrated through the consideration of an actual television receiver power supply problem.

Television receivers generally require a d.c. output of 400 volts at 200 ma. and 200 volts at 100 ma. from a 60-cycle, single-phase, 110 volt primary source. Heretofore, due to economic factors to be described in a subsequent paragraph, the full-wave, center-tap circuit shown in Fig. 1 (left) was virtually always used to obtain this output. However, the advent of the selenium rectifier enables the employment of a number of other cir-

cuits including the full-wave, bridge rectifier shown in Fig. 1 (right).

Consider, for example, the relative advantages of the bridge versus center-tap wave rectification for this application. The bridge circuit requires four rectifying elements, but makes continuous use of the transformer, hence the secondary must supply only 323 volts to attain the desired output providing there is a small drop across the rectifier. The center tap circuit, on the other hand, utilizes only two rectifying elements but only one half of the transformer secondary is used during each half cycle and therefore the secondary must supply a minimum of 646 volts,—323 from each end of the transformer to center tap—to achieve the same output. As a result, with all other factors being equal, the transformer used in the latter circuit requires a power rating 1.22 times greater than the rating of the one used in the bridge circuit.

The problem therefore resolves itself to this: Is it more advantageous to use two extra rectifying elements with a smaller transformer, or a larger transformer with two less rectifiers? When tubes were used, the extra cost, size, and filament windings involved by the addition of two rectifiers far exceeded the saving in the transformer and therefore the full-wave, center-tap circuit was usually employed. However, due to the large

Fig. 1. Full wave, center tap and full wave bridge circuit providing 400 v. outputs.

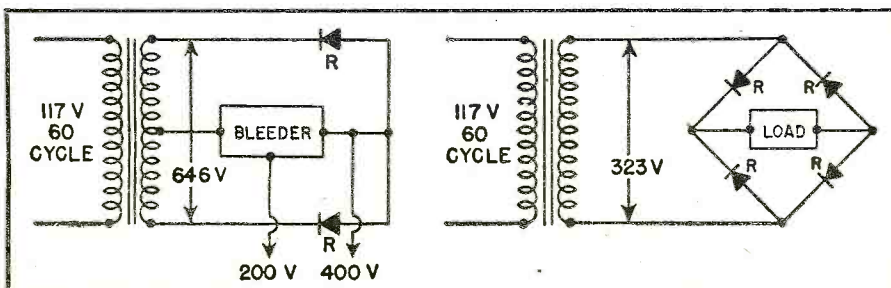

voltage drop across the tubes, the voltage required across the secondary was approximately equal to 800 volts rather than the 646 previously indicated. It should also be noted that this circuit employs a bleeder to obtain the 200 volt output.

Use of selenium rectifiers makes the bridge circuit practical. In this case the size and cost of the additional rectifiers (even though two are used in each leg, as shown in Fig. 2, to meet voltage requirements) is easily made up by the use of a smaller, lighter, and lower cost transformer. This power transformer which, due to the efficiency of the selenium rectifier, requires only a 323 v. secondary, is further simplified by the fact that a filament winding is not necessary. Power for the r.f. and video tube filaments can be obtained by placing these filaments in series across the primary source.

Another unique feature of this circuit is that the 200 volt supply is obtained by using the center tap of the transformer, thus avoiding the unnecessary heating and power losses inherent in a bleeder. A saving of at least 20 watts is effected in this manner—200 volts at 100 ma.

Add this power to that saved by the elimination of the filament (30 watts) and the increased efficiency, and it can readily be seen that a total power reduction of approximately 100 watts can be effected. The important consequence of this saving is that the set runs much cooler—approximately 20° C in the average case. This substantial reduction in chassis temperature increases the life of the rest of the components in the set and permits the design of a much more compact unit.

Excellent voltage regulation is provided by this circuit, as indicated in Table 1, with the 469 volts at no-load dropping to only 400 volts at full-load. It should also be noted that this regulation is obtained for all values of condenser *C* from 40 to 80  $\mu$ fd., the increase in capacity serving only to reduce the ripple voltage. The low no-load voltage characteristic, plus the non-critical condenser value permits the utilization of electrolytic condensers in this supply—since variation in their capacity due to aging or heating will not affect the output voltage.

The circuit shown in Fig. 2 should be particularly valuable when used in conjunction with a vibrator, as shown in Fig. 3, to power television mobile installations, "a.c.-d.c." sets, and farm receivers. In this case, the saving of 100 watts and the smaller size and lighter weight of the power transformer, are obviously extremely important features. In fact the main reason for the use of dynamotors, rather than vibrator power supplies, in these applications was due to the excessive weight and power consumed by such circuits using rectifier tubes.

However, the vibrator power supplies shown in Fig. 3 are actually 40% more efficient than a dynamotor and hence draw an equivalent degree

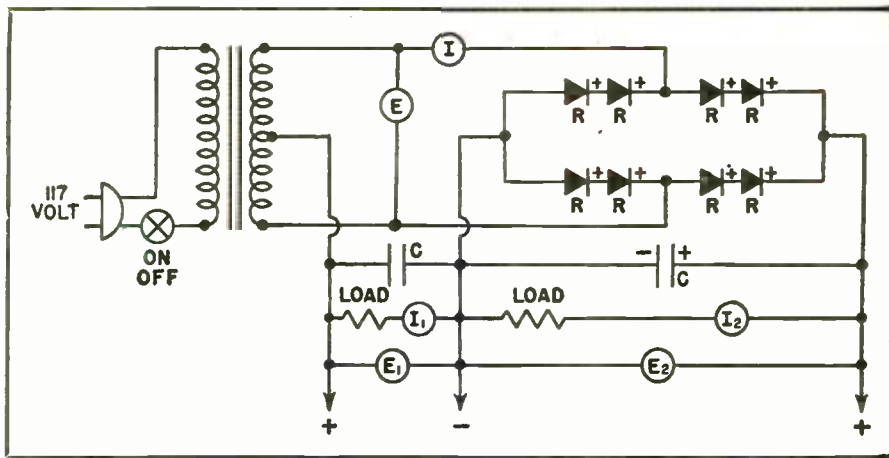

Fig. 2. Full-wave bridge circuit using Type 404D2795 selenium rectifiers. This circuit provides a 400 v., 200 ma., and a 200 v., 100 ma. output. See Table 1.

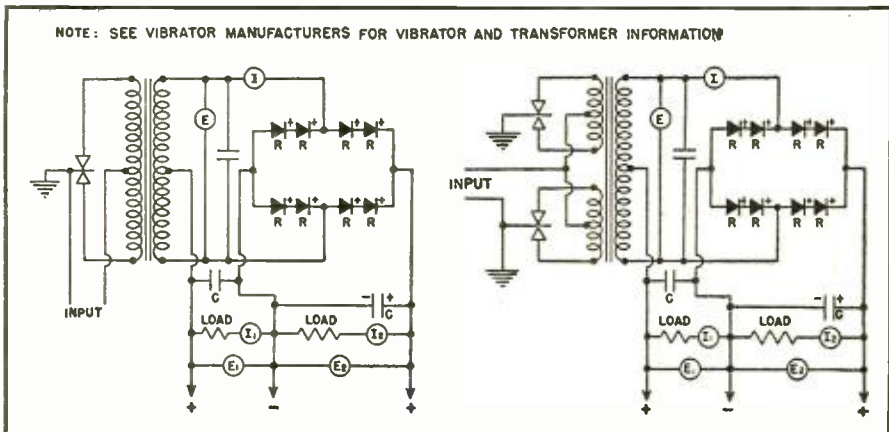
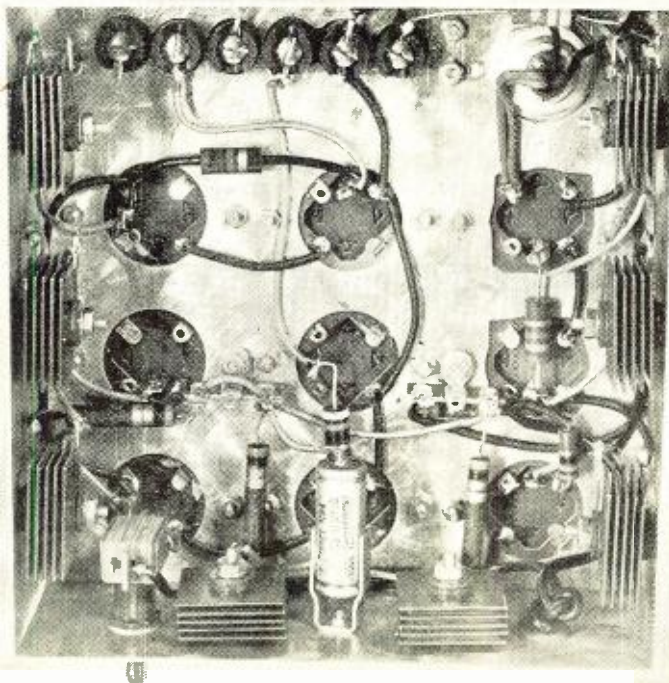

Fig. 3. Selenium rectifier vibrator power supplies developed for use in a.c.-d.c., mobile, and farm television receivers. See Table 1 for regulation characteristics.



Multiple voltage power supply, weighing three pounds, is built on a 7" x 7" chassis.



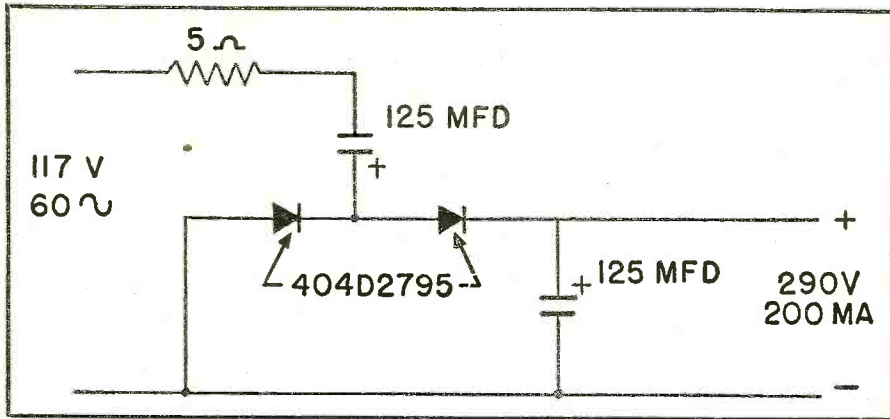

Fig. 4. Selenium rectifier voltage-doubler circuit which eliminates the need for the power transformer and filter choke in 7" television receiver units.

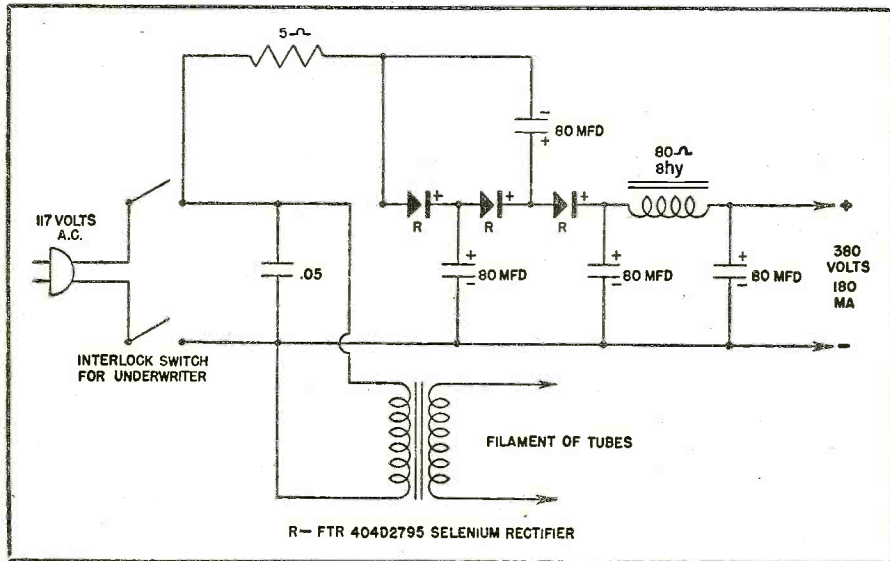
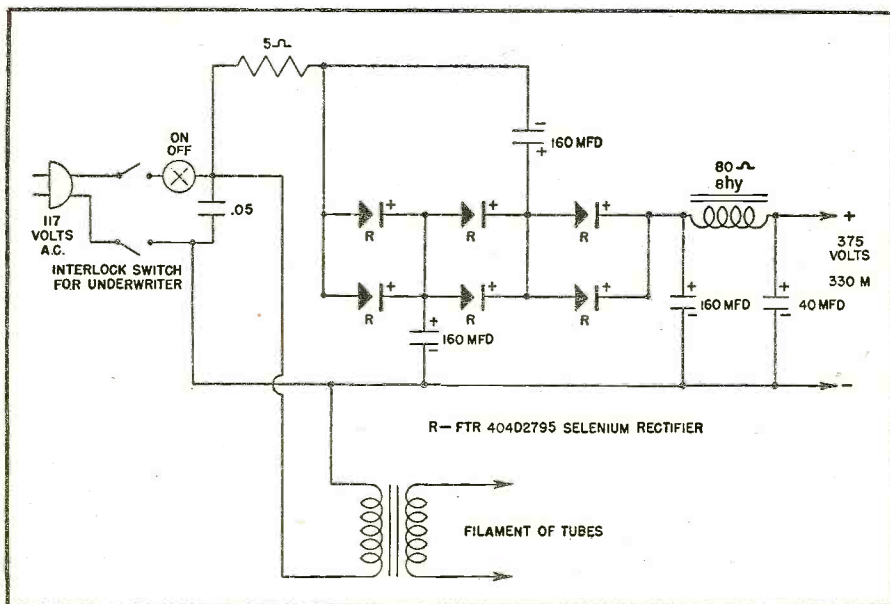

Fig. 5. A 68-watt television power supply which uses the miniature selenium rectifiers manufactured by the Federal Telephone and Radio Corporation.



Fig. 6. A 122-watt television receiver power supply using a voltage tripler circuit which incorporates a group of miniature selenium rectifier units.



less battery current. Furthermore, in addition to being lighter and smaller than a dynamotor providing the same output, these supplies have fewer sources of trouble and are easier to service. Voltage regulation characteristics of these supplies are given in Table 1. Vibrator manufacturers should be consulted for the optimum vibrator and transformer to use in this application.

As previously indicated, the bridge-type, full-wave rectifier is one of a number of supplies that may be used for television receivers. Fig. 4 shows a voltage-doubler circuit, used for 7" sets, wherein the power transformer and filter choke have been eliminated completely. It is this supply that has been mainly responsible for the recent appearance on the market of the new low cost-size-weight television receivers.

The reduction in size, cost, and particularly weight does not stop with the difference between the power transformer and the selenium rectifiers, but this factor plus the lower chassis temperature permits additional economies such as the use of a lighter, smaller cabinet. The over-all cumulative result is a 7" television set that weighs only 26 lbs.—the approximate weight of the power transformer alone in some previous 7" sets providing the same service.

The elimination of the power transformer also provides an electronic advantage. Since stray magnetic fields cause interference in the cathode-ray tube, it is often necessary to confine the power supply to a special chassis position to minimize this effect. The use of selenium rectifiers places no such limitation on the engineer and they can be installed in any convenient location on the chassis.

For larger sets the voltage tripler circuits shown in Figs. 5 and 6 or the multiple power supply shown in Fig. 7 may be utilized. This latter circuit particularly points up the assertion made previously in the article that additional rectifiers can easily be inserted in the circuit to achieve an improvement in design. This circuit uses a separate rectifier circuit for each functional stage, i.e., audio, sweep, r.f., bias and focus, instead of using a common supply for them all. This, obviously, would be prohibitive if tubes were used.

The use of separate power supplies for each functional unit eliminates the problem of current changes in one circuit affecting the others, such as the action of a.v.c. defocusing the set. With a separate supply some controls now on the front panel can be factory pre-set and still provide optimum performance. Furthermore the remaining controls that require adjustment by the user will be simplified by the fact that there is no interaction between one circuit and the other; that is varying the gain will not affect the sweep circuit, and vice versa.

(Continued on page 164)



# Confessions of a SURPLUS HOUND

By CECIL R. NELIN

I SUPPOSE nobody ever set out deliberately to become a surplus hound; it's something that sorta creeps up on you insidiously, like hang-nails, halitosis, housemaid's knee or some of those other hideous maladies to which BCL's are constantly exposed. It's really kinda hard to decide just how it all started. Maybe it started back in 1940 when W5JIE got his ticket, as I was exposed to a considerable amount of his enthusiasm. A couple of years in the Navy as a radio technician only aggravated the malady, as I was constantly exposed to the bull sessions of temporarily silenced amateurs. By the time I got back to civilian life, I had that little rig all planned: bandswitching, ganged tuning, v.f.o. and an umpteen element beam that would practically reach out and write up those juicy QSLs, to say nothing of mailing them. Of course I would have to learn code, but that was only a very minor detail.

Perhaps you might say it started that black Monday (it really was a lovely day otherwise) that I opened my favorite radio magazine and saw *THE AD*. It was a golden, once-in-a-lifetime opportunity; the ad said the transmitter cost the government \$1800.00 and I could have it for only \$19.95 complete with dynamotor and all accessories FOB Oshkosh. A little quick arithmetic showed a net saving of \$1780.05 on a mere \$19.95 investment. Not bad! Not bad at all!

I showed the ad to the XYL who was busy looking at an ad about a hat sale. While she did not share my boundless enthusiasm, I pointed out that I could probably get most of the parts for a rig out of it; that it would be good stuff because the government had such rigid requirements; that we would save (here I raised my voice for emphasis) \$1780.05. Maybe I caught her off guard, maybe she couldn't resist a bargain, or most likely it was my persuasive sales talk. Of course that hat I promised her may have had something to do with it. More callous-minded individuals might even say that we compromised. It is true that she pointed out we could also save an additional \$6.98 by buying the hat, too. Carefully we rechecked the bank account as our state has rigid laws about checks with insufficient funds to cover them, and emerged triumphantly with 98¢ remaining after I ordered the super-



**Don't say we didn't warn you—this article gives the XYL plenty of ammunition and is dynamite for you.**

dooper dream special. I even sent the letter air mail to get the order in as quickly as possible, before some other astute individuals beat me to this bargain. I then sat back to wait somewhat impatiently.

Four weeks (and twenty-one trips to the express office) later the transmitter arrived. There was one box only a little smaller than our GI house and several smaller boxes that two men could lift without straining very much. The express man said they would deliver it, if I could wait just a few hours, and since it was too big to haul in the family car, there wasn't anything else I could do.

My first shock came after the express man finished unloading and presented the express bill—it looked like the national debt! After emptying the sugar bowl and the baby's bank, I borrowed the remainder from an unsuspecting neighbor. I started to unpack my treasure but the cases seemed to be riveted shut. Since there was probably some poor fellow trapped inside after clinching the rivets, I rushed down to the hardware store and purchased (on the cuff) a nice husky wrecking bar and a large ax. If I had known what to expect, I would also have bought a few sticks of dynamite or maybe some war surplus TNT. There was some slight objection from the XYL about those big boxes littering up the front yard, but that was masterfully handled with a saving of \$28.49 by the purchase of a dress at a bargain price to match the hat. That brought my total savings to date to

\$1815.52 less some express charges.

After the gear was unpacked and stacked in the garage, I still had half a lumberyard in the front yard, where it remained as the crates were too big to move unaided, except for one crate that was just about the right size for a doghouse. I spent so much time in it later that I just painted "Home Sweet Home" over the door, moved out the dog and hung out a "No Vacancy" sign! Since there wasn't room in the garage for the car now (only the front part) I figured I might as well work on the gear in there. I found out, rather quickly that tearing down the gear wasn't going to be very easy. It had apparently been assembled with tweezers after which all screws were tightened with power screwdrivers and sealed for eternity with some mixture even more potent than the half-glue, half-paint mixture used by painters for sticking windows. It is almost as potent as the preparation used to stick windows on railroad cars. Several hours of more or less futile maneuvering convinced me it would be better to use the gear like it was, rather than tear it down. Besides, a power supply is a big part of the cost of a rig, so I could save some more money by using the dynamotor that came with the rig if I had some storage batteries.

I dug through all the magazines and surplus ads again. &%\$#\*@"¼¾/!!! That blamed transmitter was now only \$9.95. I got gypped! If I had only waited two days longer to order it, I

*(Continued on page 160)*

# TRAP CIRCUITS for RECEIVERS

## Television



Television image as it appears when sound voltages reach control grid of cathode-ray tube. This type of interference can, in most cases, be eliminated by employing the proper traps.

### **A discussion of the various types of wave traps used in commercially-built television receivers.**

TELEVISION receivers are continually beset by a host of interfering signals, any one of which is easily capable of distorting or completely destroying the desired image. Fortunately, many of these interfering signals never get beyond the input tuner and so are suppressed before any harm is done. Some, however, are so close to the channel frequency to which the set is tuned that they are able to penetrate the r.f. defense and reach the video i.f. system. This system actually constitutes the main bulwark against all interference and once a signal passes through these stages successfully, there usually exists no further stop-gaps between the video detector and the cathode-ray tube. Every effort must be made to suppress any signal which is capable of distorting the reproduced image.

In order to receive a 6 mc. band of frequencies, the r.f. and converter tuning circuits are designed with a low "Q." This means that the sides of the input curve are not very steep, like

the sides of a rectangle, but rather tend to taper off gradually. Fig. 1A illustrates a typical input characteristic of a modern television receiver. With a response of this type, voltages at the frequency of the sound carrier of the next lower channel or the picture carrier of the next higher channel could penetrate through the r.f. stages and reach the video i.f. system. Unless trap circuits are inserted in the video i.f. system (or even beyond), the effect of these interfering signals will be detrimental to the image.

To ascertain the frequency of the interfering signals, suppose the receiver is tuned to channel 3 (60-66 mc.) and the video carrier i.f. value is 26.4 mc. The sound carrier of the next lower channel (54-60 mc.) is at 59.75 mc. A signal at this frequency when mixed with the local oscillator (87.65 for channel 3) will develop a difference frequency of 27.9 mc. This is one interference signal frequency.

The second interference signal is the picture carrier of the next higher

channel (66-72 mc.). When this beats with the same local oscillator, a difference frequency of 87.65-67.25 mc. or 20.4 mc. is produced.

The two frequencies (1) sound from the next lower channel (27.9 mc.) and (2) picture carrier from the next higher channel (20.4 mc.) must be eliminated from the video signal before it reaches the cathode-ray tube. Channel 3 is used in this illustration but any other channel could have been chosen. In all cases where closely adjacent channels exist, the two interfering frequencies will be 27.9 and 20.4 mc. for this receiver. Note, however, that there are channels which are not subject to such interference. Thus, channel 1,\* (44-50 mc.), has neither a closely adjacent lower nor a closely adjacent higher channel. By closely adjacent we mean channels which follow each other without any frequency separation. Channel 1 is followed by channel 2, but the end of channel 1 and the beginning of channel 2 are separated by 4 mc. Channel 1 is 44-50 mc.; channel 2 is 54-60 mc. This 4 mc. is sufficient to prevent any of the frequencies in channel 2 from adversely affecting channel 1. However, channel 2 (54-60 mc.) is closely followed by channel 3 (60-66 mc.) and interference is possible. The same is true of many of the other channels. Hence the importance of using these traps. The trap frequencies will vary with the video and audio i.f. values employed in the circuit. The purpose of the traps, however, remains unchanged.

The objection may be raised that traps are not really necessary because under existing regulations adjacent channels are not assigned in *any one community*. This is true. However, communities which are located comparatively close to each other are assigned to adjacent channels. Thus, consider New York and Philadelphia, only 90 miles apart. New York is assigned channels 2, 4, 5, 7, 9, 11, and 13; Philadelphia is assigned channels 3, 6, 8, 10, and 12. Any set situated between these two cities would certainly be subject to considerable interference and would definitely require the above-mentioned trap circuits. This same situation is true in many other parts of the country.

There is one additional trap which

\*Note: The FCC has recently withdrawn channel 1 from television service. The numbering of existing channels will not be changed, thus present channel 3 will continue as channel 3, etc.

is always found in television receivers and this is a trap designed to prevent the audio i.f. voltage of the same channel from reaching the cathode-ray tube. In any channel, the audio i.f. frequency is sufficiently close to the bandpass of video i.f. systems to be able to pass through to the cathode-ray tube unless special precautions are taken. This trap is even more important than any of the other traps because adjacent channel stations are not always present, but the sound of the same channel is. An indication of sound interference at the cathode-ray tube is the appearance of horizontal dark and light bars across the face of the tube. The width of the bars varies with the audio frequency; the intensity of the bars is proportional to the amplitude of the audio signal. When both the amplitude and the pitch of the audio signal change, ripples pass across the picture like water waves when the wind is high.

### Placement of the Traps

The trap circuits are generally placed in the video i.f. system although some manufacturers go so far as to include one or two in the video frequency amplifiers. The danger of permitting these interference signals to get too close to the cathode-ray tube is that they may have become so strong, due to successive amplification, that a single simple trap may be incapable of attenuating them below the point of interference. Sound traps for the same channel must not be used until the video and sound signals have been separated.

### Type of Traps

(a) *Series Traps.* A series type of trap circuit is shown in Fig. 1B. It is placed between two i.f. stages and tuned to the frequency to be rejected. Trap circuits are sharply tuned networks, designed to reject one frequency, or, at most, a narrow band of frequencies. When a signal at the trap frequency appears at the plate of  $V_1$ , Fig. 1B, the impedance offered by  $LC$  is high, absorbing most of this interference voltage. A negligible amount appears across the input circuit of the following i.f. amplifier. At all other frequencies, the tank offers negligible impedance and the desired signal passes easily.

(b) *Absorption Traps.* The absorption trap, shown in Fig. 1C, is the most widely used type of rejection circuit. It consists of a coil (and parallel fixed condenser) inductively coupled to the plate load of an i.f. amplifier. When the i.f. amplifier receives a signal at the resonant frequency of the trap circuit, a high circulating current develops in the trap, and because of the coupling between the trap and the plate coil, the voltage in the video coil, at the trap frequency, becomes quite low. As a result, very little of this interference voltage is developed across the video coil and correspondingly little of this voltage reaches the next amplifier.

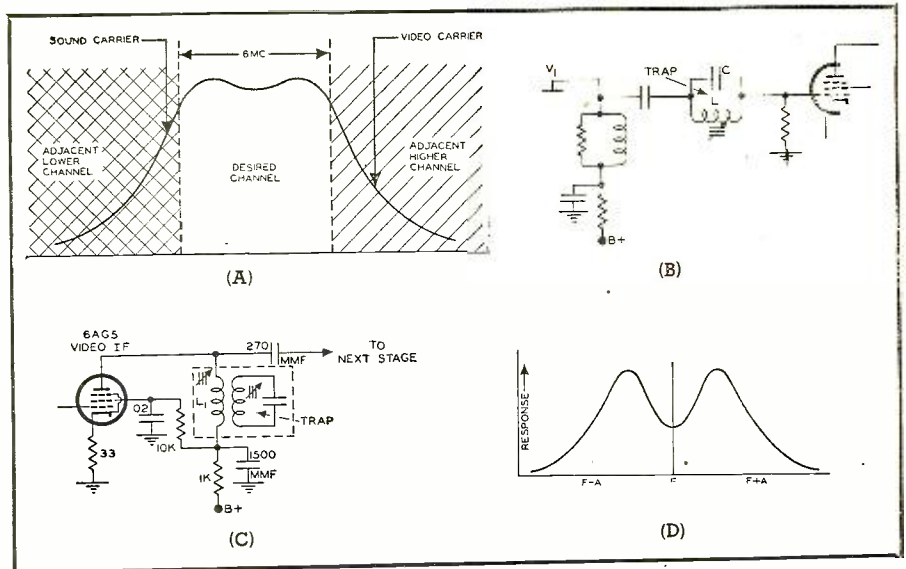

Fig. 1. (A) The r.f. response curve of most television receivers. Note that signals from adjacent channels can pass through r.f. system. (B) Series trap. (C) Absorption type trap. (D) Double-humped response characteristic of closely coupled tuned circuits.

To explain this action more fully, two resonant circuits closely coupled will give a double-humped curve, such as shown in Fig. 1D. Note the sharp decrease in primary current at the center frequency. In the case of the two tuned circuits of Fig. 1C,  $L_1$  is tuned to a band of frequencies while the secondary is sharply set at one frequency. Since the primary band coverage includes this one frequency, there is a sharp drop in primary current at this frequency, because of the presence of the trap. It is this interaction between coils which produces the marked decrease of each of the trap frequencies. The other frequencies in this signal are unaffected by the trap.

(c) *Cathode or Degenerative Traps.* A cathode trap, shown in Fig. 3A, is a parallel resonant circuit coupled to a coil in the cathode leg. The coil  $L_1$  in series with  $C_1$  forms a series resonant circuit at the frequency to which  $L_2$  is tuned. This permits  $V_1$  to function as a normal amplifier for all signals at this frequency. However, at the resonant frequency of the trap, a high impedance is reflected into the cathode circuit (by the trap) and the gain of

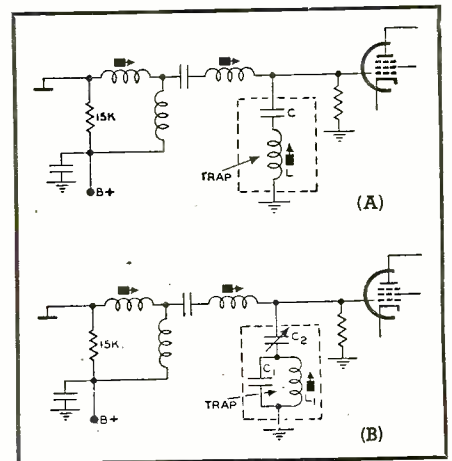

Fig. 2. Two types of parallel traps.

this stage is reduced by degeneration.

Another type of cathode trap, illustrated in Fig. 3B, places the parallel circuit directly into the cathode leg. At the resonant frequency of the trap the impedance in the cathode leg will rise, producing a large degenerative voltage and reducing the gain of the amplifier. At all other frequencies,

(Continued on page 128)

Fig. 3. Two types of cathode or degenerative wave traps used in television receivers.

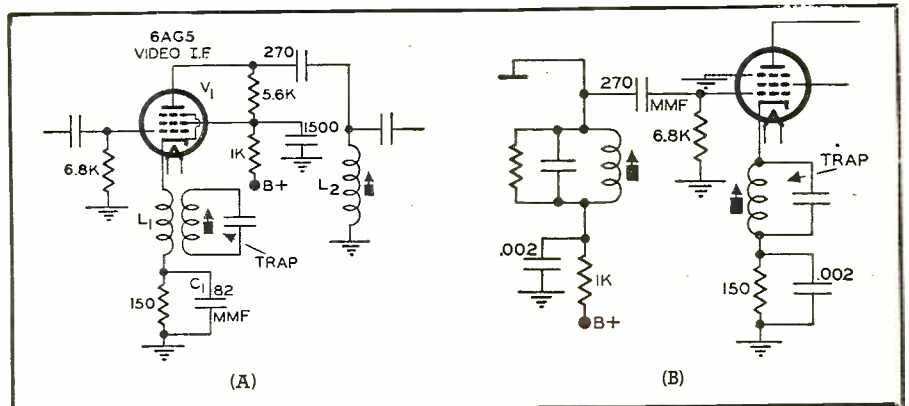



# International SHORT-WAVE

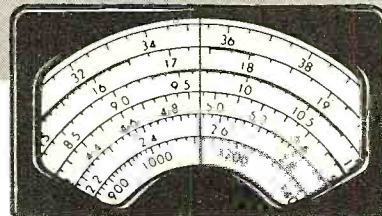

Compiled by **KENNETH R. BOORD**

**I**N OBSERVANCE of its 20th Jubilee in March, 1947, PCJ, "The Happy Station," Hilversum, Holland, launched a worldwide contest for the best answer to the question: "Can International Short-Wave Radio Promote World Peace?" First prize of a round-trip by K.L.M. (Royal Dutch Airlines) to Holland and a week's stay in that picturesque, little country went to Miss Elizabeth Holland, of 29 Gower St., St. John's, Newfoundland. During her recent trip to the Netherlands, Miss Holland appeared before the microphone with Eddie Startz on one of his "Happy Station Program" periods.

Thanks to Mr. Startz and to Henry Callahan, Pennsylvania, we present below Miss Holland's winning essay:

\* \* \*

### "Can International Short-Wave Radio Promote World Peace?"

"As nations are just groups of individuals, and the world just a number of these groups, the idea of peace and unity must begin with the individual, and the best place to instill this idea into him is in his own home—the place where he is most receptive. His suspicion of the fellow who speaks a different language must be done away with, and replaced by a feeling of fellowship and the knowledge that the other fellow is basically the same as he is, with the same needs and feelings. For unless there is unity amongst individuals, there can never be unity amongst nations, and without unity there is no peace.

"With the ever more widespread use of radios, many millions permit their ideas and their attitude towards others to be formed by what they hear on them, so that radio has become the most powerful force for good or evil in the world. With this power in its hands, *International Short-Wave Radio* should use it so that it not only CAN but **MUST** promote *World Peace!*"

We offer sincere congratulations to Miss Holland!

\* \* \*

### Port Moresby On Air

*Radio Australia* reported some time ago that a new short-wave outlet at Port Moresby, New Guinea, was to take the air on 9.520 on June 28, using the call-sign VLT, with a power of 500 watts, and to relay the medium-wave outlet 9PA. A Swedish DX

broadcast reported this station signing off at 1733.\*

However, August Balbi, Calif., reports VLT5, Port Moresby, heard on 7.28 at 0400-0500; *English* news 0400, followed by weather report; asked for reports; full schedule unknown; fair to good signal. Mr. Balbi also has heard VLT7, 9.52, from 0130, with fair to good level, also. He comments that when he first heard the 9.520 channel, it had surprisingly good signal for the season of the year, but adds that since this is a bad spot for QRM, it is unlikely that 9.520 will be used widely by VLT, and if so, it is improbable



Miss Elizabeth Holland of Newfoundland, winner of PCJ's essay contest on the subject "Can International Short-Wave Radio Promote World Peace?" appears with Eddie Startz, master of ceremonies, on a "Happy Station Program" during her recent trip to the Netherlands. The trip was the top award in the world-wide competition sponsored by the Hilversum station in observance of its 20th Jubilee in March, 1947.

that good, consistent reception will be currently possible in America.

Grady C. Ferguson, North Carolina, airmails me that he is hearing VLT5, 7.280, early mornings, best around 0600-0700, announcing as being in the "Papuan service"; relays programs from Australia's ABC. And an airmail report just in from George Major, Western Australia, informs "VLT5 carries the Australian Broadcasting Commission's medium-wave 9PA programs, which consist of many sessions from Australia. VLT5 signs on at 1545, and is heard well at my location from 0245 to 0800, other times not checked. Have checked on the VLT channel, 9.520, since June 28 when was supposed to begin transmissions in 31-meter band, but have heard no signal there, and no mention of this frequency (9.520) has been made by

VLT5 (7.280). I presume that call-signs will be VLT1 for 16 m. outlet (if and when used); VLT2 for 19 m.; VLT3 for 25 m.; VLT4 for 31 m., and VLT5 for 41 m. (latter as announced)."

I believe this new station is intended primarily for local listeners—those in the British New Guinea area who may be unable to pick up the medium-wave station, 9PA.

British New Guinea (or Papua) is the southeastern part of the Island of New Guinea, located north of Australia. Its area is estimated at 90,540 square miles with an estimated native population of 338,822.

In 1940 the European population was 1822. The British Government annexed the territory in 1884 and it was administered by the Government of Queensland until 1906. It is now known as an Australian Territory. The Japanese invaded Papua in December, 1941, but were driven out a year later.

Chief exports of Papua are copra, gold, rubber, and desiccated coconut.

\* \* \*

### Swedish Publication

A special DX magazine, published by *Radiojant* (Stockholm Radio), including a current list of world short-wave stations, compiled by Arne Skoog, the well-known Swedish DX authority, may be had by sending *three* International Reply Coupons (for sale at your local post office) to DX Editor, Swedish Broadcasting Service, Stockholm 7, Sweden. The publication is called "Varlden i Hög-talaren" ("The World in Your Loud-speaker").

\* \* \*

### Verification Data

QRA of VY1RG, 6.150, Venezuela, is Radio Cabimas, Calle Democracia, Cabimas, Venezuela. (Nilsson, Sweden)

Reports to CE622, 6.220, Santiago, may be sent to P. O. Box 2626, Santiago, Chile. (Stephen, Sou. Africa)

Address of *Radio Malaya* in Kuala Lumpur is Dept. of Broadcasting, Oriental Building, P. O. Box 534, Kuala Lumpur, Malaya. (DXSA, Sou. Australia)

Reports to Japanese stations should  
(Continued on page 104)

\* (Note: Unless otherwise stated, time herein is expressed in American EST on a 24-hour clock basis; add 5 hours for GCT. "News" means in the English language.)

Fig. 1. Front view of gain measuring set.

**Direct reading db. meter  
indicates at a glance  
stage-by-stage or over-all  
performance of audio  
amplifiers.**

**By W. E. NORMAN**



# GAIN MEASURING TEST UNIT

WHEN working at audio frequencies, the question, "How much gain?" will come up quite often. In order to compute gain, it is necessary to know input and output signal values in the same terms. This difference between input and output is called "gain." An instrument capable of measuring these extremes will play a vital role in all types of work with sound equipment.

The decibel is a convenient unit to use for gain measurement because it is approximately proportional to the sensation of sound volume to our ears. This cannot be said for voltage or wattage which are usually spoken of as ratios. There is no "standard decibel" so the reference level must be included. This is usually given for zero decibels.

Zero decibels can be expressed as the threshold of audibility at 1000 cycles-per-second. The statement of frequency in this definition is necessary because the ear responds to low frequencies very poorly, but aural response improves as the frequency rises until 3000 or 4000 cycles-per-second is reached, at which point it begins to taper off until at 20,000 cycles-per-second sound becomes inaudible to the human ear.

A change of 1 db. is barely perceptible to the ear. A rise of 3 db. can be noticed by the trained observer. Although a 5 db. change from "0" to plus 5 db. requires a power increase of only .013 watts, it takes an increase of 410 watts to bring about a change of, say, from 45 to 50 db. The change of voltage level in db. is  $db. = 20 \log_{10} (E_1/E_2)$ . Thus the decibel, being logarithmic, can simply be added or subtracted when used to express gain. An example will easily show this convenience. Consider a voltage amplifier with a gain of 60 db., a matching network with a loss of 10 db., a master mixer and driver with a gain of 30 db., a line transformer with a loss of 2 db., and a power amplifier with a

gain of 20 db.  $60-10+30-2+20=98$ . The over-all gain is 98 db.

Audio power can be measured with a db. meter, but in this case the reference level must be considered. Power level in db. is,  $db. = 10 \log_{10} (\text{watts}/\text{reference level in watts})$ . A meter with a reference level of .006 watts into 500 ohms or 1.73 volts into 500 ohms was used because 500 ohm transformers and 500 ohm lines are common.

Most multimeters have decibel scales on them, but very few read below -12 db. which is about the output level for voltage amplifiers. This limits these units to the measurement of output and driving signals. Signals from microphones and phonograph pickups are usually very minute. Manufacturers will state the average voltage or decibels obtainable from the mike or pickup, and when an amplifier is being tested a signal of the proper value from the audio oscillator should be injected. Suppose this signal should be -66 db. This is too small a value to read on the meter because with a reference level of 6 milliwatts into 500 ohms the voltage is .00173 volts. However it is possible to take the signal indicated on the db.

meter and attenuate it by means of precision pads. To do this on the Gain Measuring Set, described in this article, it is only necessary to throw in the -40 and -20 pads on the "INPUT REFERENCE LEVEL," turn the "-DB. BELOW REF. LEVEL" attenuator to -6. This gives a total of -66 db. on 500 ohms. If other than 500 ohms output impedance is used, an additional loss for the rematch must be included. Should the amplifier input be 50 ohms, the "OUTPUT IMPEDANCE" switch would be turned to 50 ohms. It will be noticed that a loss of -20 db. is effected in this rematch, thus only -40 db. will be needed on the "INPUT REFERENCE LEVEL" and -6 db. on the "-DB. BELOW REF. LEVEL" attenuator, giving a total of -66 db. The "AUDIO SIGNAL OUTPUT" should be loaded by connecting it to the 50 ohm amplifier input. The final operation is to adjust the "AUDIO INPUT GAIN" with the "DB. METER" switch on "INPUT" to 0 db. on the meter. The signal is now ready to use. If the amplifier input were 500,000 ohms or any very high value, the input would offer no load for the audio signal output. The pads in the "OUTPUT

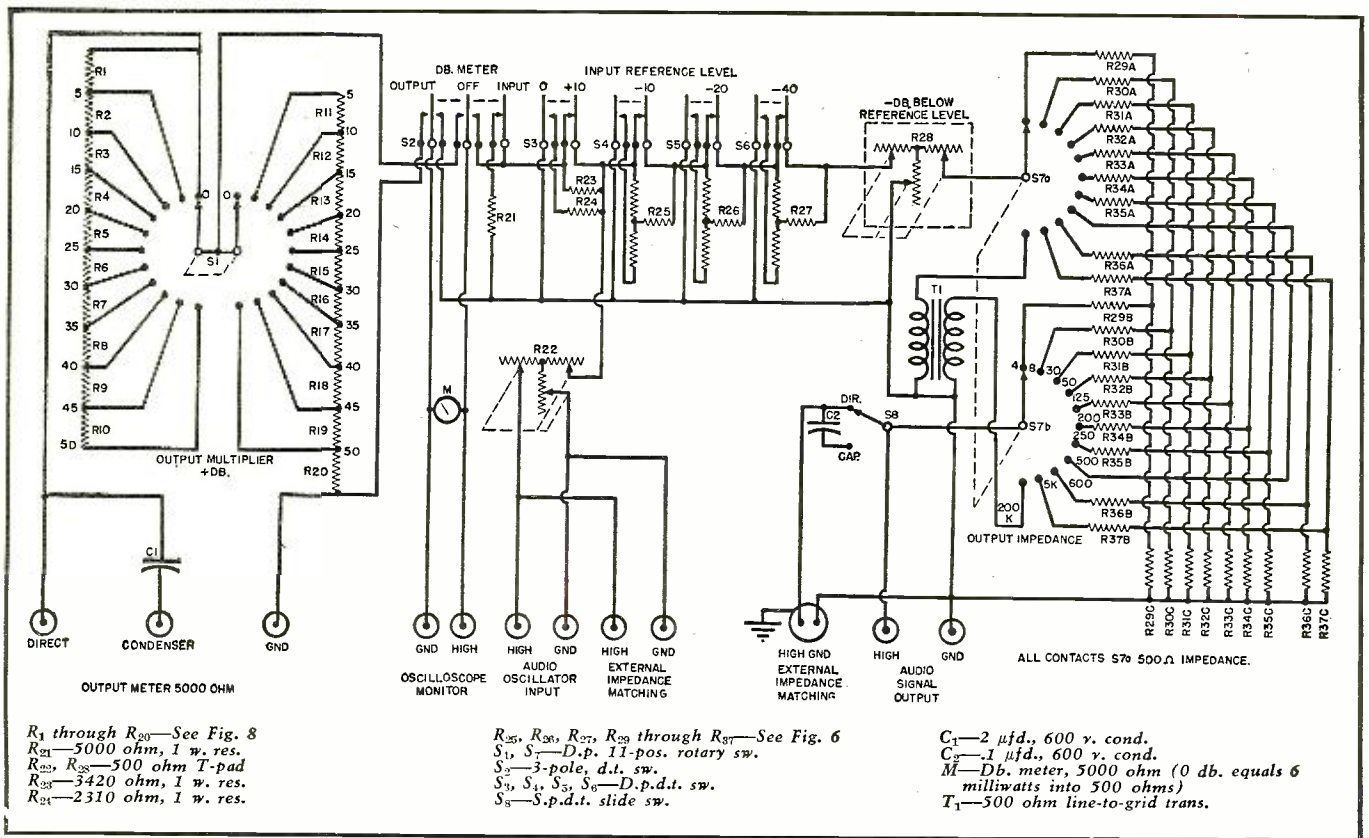

Fig. 2. Circuit diagram and parts list for gain measuring test set.

"IMPEDANCE" selector are designed to give the correct signal when fully loaded, so when working into such high impedances from, say the 500 ohm output, it will be necessary to

have a 500 ohm resistor in the "EXT. IMP. MATCH" jacks which are provided, in order to load the output. By being able to adjust the input sign-

put meter on the output, and subtracting the db. input algebraically from the db. output, the question, "How much gain?", can be answered. Frequency response curves can be run and audio service or experimental work can be done precisely, with such data of a definite nature that can be tabulated and filed away for future reference.

The "AUDIO INPUT GAIN" control was incorporated because of the increased convenience it offered. Since constant input and output impedance was desired, a Mallory 500 ohm "T" pad was used. The "EXT. IMP. MATCH" jacks are used to load the audio oscillator in case it does not have a 500 ohm output. It will be found that almost all audio oscillators must be loaded properly in order to duplicate the manufacturer's frequency response specifications.

It was found easier to make the resistors for the "INPUT REFERENCE LEVEL" "T" pads since a high degree of accuracy was desired. They were wound with meter wire doubled on a non-metallic material to provide the non-inductive feature. Fine adjustment was made by putting them on the bridge and unwinding the wire until the balance was obtained, then soldering it to the lead. Details of the resistors are shown in Fig. 5.

A line-to-line transformer was used on the audio signal output in the first tests but it was found that ordinary transformers were too inaccurate to be used in this instrument. A good transformer should be used because

Fig. 3. Impedance switching arrangement for transformer-coupled output.

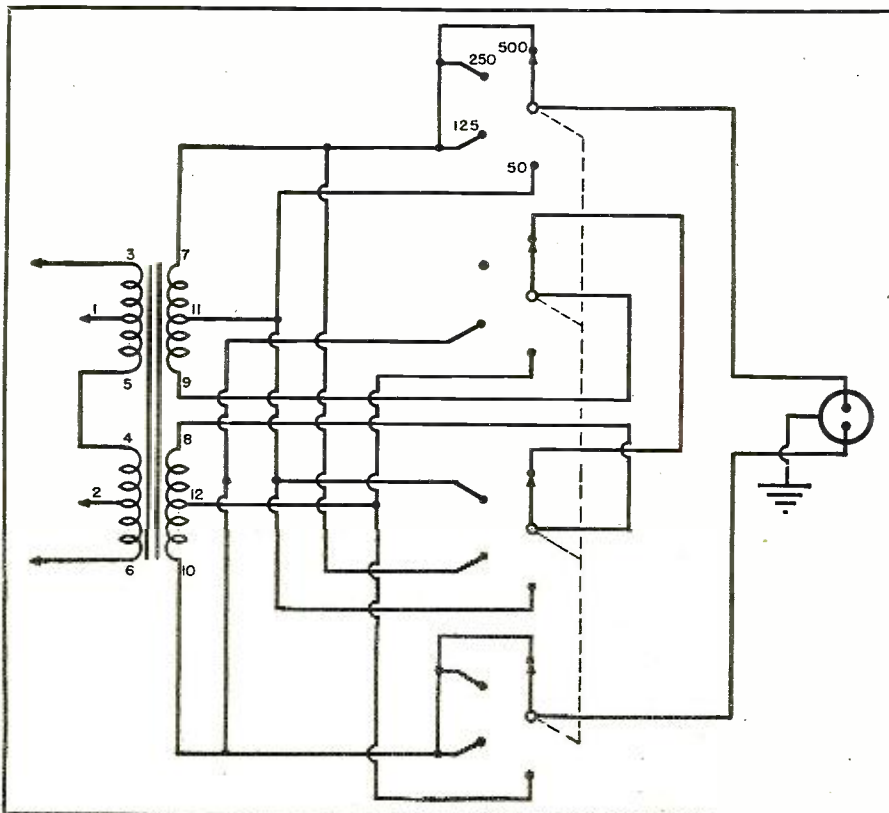

maximum accuracy is required of this test instrument. The unit should be able to pass from 30 to 15,000 cycles-per-second with negligible loss and a turns ratio accuracy of 1%. A transformer gives us the advantage of working into a balanced line, isolation, and a handy selection of impedances at negligible loss (which can be made selective on a switch as shown in Fig. 3).

The numbering of the taps on the line-to-line transformers will be different for different manufacturers, therefore the connections shown in Fig. 3 are only indicated to illustrate the switching possibilities. This arrangement can be worked out for any transformer which has 50, 125, 250, and 500 ohm selection on the output.

The cheap transformer originally tried was discarded. To keep the cost down it was decided to make up a group of "T" pads for the impedances wanted. How to figure these pads is shown in Fig. 6.

Impedance matching is very important and it must be remembered that any loss in a mismatch must be added to any losses incurred at the "REFERENCE LEVEL" or "ATTENUATOR." Rather than calculating these losses, it is simpler to have the needed impedances available on the "AUDIO SIGNAL OUTPUT." To match very low impedance inputs, such as 20 ohms down to .1 ohm, a transformer is the best solution because the minimum loss for a "T" pad becomes higher as the impedance goes down. This means that if the pad has a loss of 30 db. the maximum signal that could be delivered would be -30 on the "OUTPUT IMPEDANCE," +10 on the "REFERENCE LEVEL" equals -20 db. If this signal is not sufficient to drive the input properly there is no alternative except to use a transformer.

To work into a balanced line input from a "T" network it is best to disconnect the center tap of the input transformer because if the ground of the audio oscillator or oscilloscope became connected to the unit being tested, it would be working into half of the input transformer to ground. To avoid the necessity of doing this, a transformer or a network of "H" pads should be used in the Gain Set. See Fig. 11.

The audio signal output will prove handy as a signal injector when troubleshooting between stages in an amplifier. To adapt it for this purpose, a switch was used to throw a coupling condenser ( $C_2$ ) in series for d.c. isolation. Since in all probability very high impedances will be investigated, it would be well to load the "AUDIO SIGNAL OUTPUT" with a resistor whose value matches the selected impedance in the "EXT. IMP. MATCH" jacks. It might be mentioned here that the coupling condensers and "EXT. IMP. MATCH" jacks were incorporated in the unit to eliminate the necessity for using con-

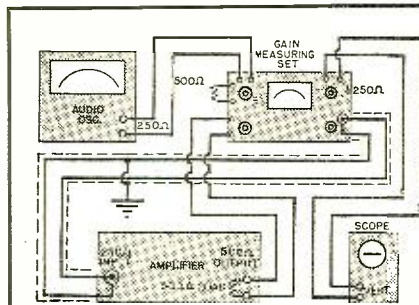

Fig. 4. A typical setup that may be used for the testing of any type of amplifier.

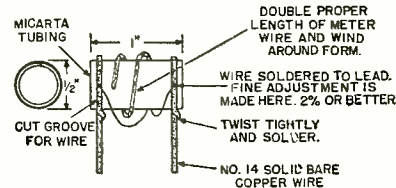

Fig. 5. The method used in making precision, non-inductive resistors. Where un-insulated resistance wire is used, wind string or thread along the wire for spacing. Dip the completed resistor in beeswax or impregnate with bakelite varnish.

$$R_a = \frac{\text{INPUT } Z}{\text{TANH } \theta} - R_c$$

$$R_b = \frac{\text{OUTPUT } Z}{\text{TANH } \theta} - R_c$$

$$R_c = \frac{\sqrt{\text{IN. } Z \cdot \text{OUT. } Z}}{\text{SINH } \theta}$$

$$\theta = .115 \times \text{LOSS IN db.}$$

DB Loss	Input Z	$R_a$	$R_c$	$R_b$	Output Z	Res. No.
30	500	498	2.94	1.06	4	R29
30	500	496	4.16	3.85	8	R30
20	500	485	24.80	5.26	30	R31
20	500	478	32.00	19.00	50	R32
20	500	459	50.70	76.90	125	R33
10	500	387	225.00	19.50	200	R34
10	500	363	249.00	57.00	250	R35
10	500	260	351.00	260.00	500	R25
20	500	408	101.00	408.00	500	R26
40	500	490	10.00	480.00	500	R27
10	500	232	386.00	360.00	600	R36
20	500	190	320.00	4790.00	5000	R37

Fig. 6. The values of T-pads used and method for computing them. Accuracy of about 2 per-cent, or better, is the goal.

densers or resistors on the test leads.

The resistors for the output multiplier can either be made or hand-picked from ordinary resistors, if an accurate bridge for such measurements is available. One per-cent resistors should be the goal. Fine adjustment can be made on low value resistors by selecting one of a little higher value than required and then paralleling a high value resistor. Fine adjustments on high value resistors can be made by selecting the high resistor nearest the value required and

on the low side then adding a low value resistor in series.

This output multiplier will increase the flexibility of the instrument since when input signals are being investigated there are usually output signals to measure. A meter switch allows the same meter to be used for both input and output. The resistance remains 5000 ohms for all steps. This is important if the loading of the output of the unit being tested is to be kept the same no matter where the

(Continued on page 167)

Fig. 7. Rear view of gain measuring test unit. Portion of the shield has been removed to expose S. The center wafers of S. is used for tie points.

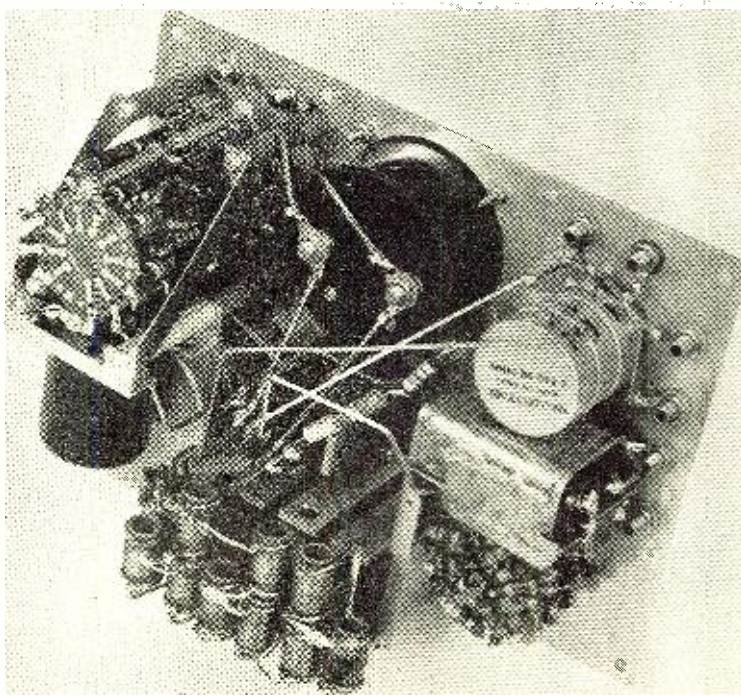

# A LOW COST VOLT-OHMMETER

Front panel view of the home-built volt-ohmmeter. The battery is connected externally through a plug.

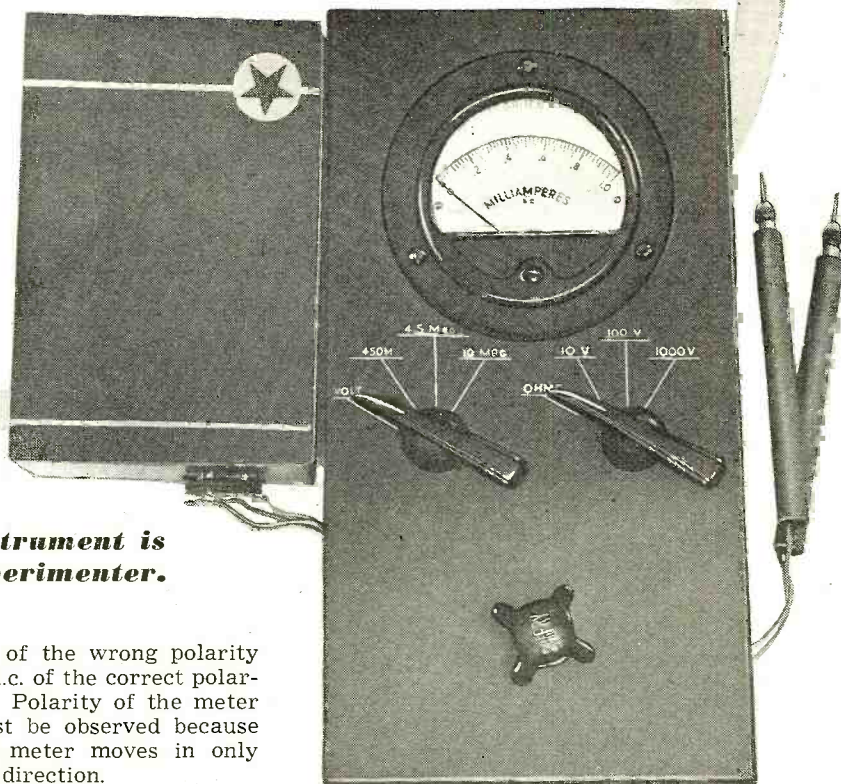

By THOMAS R. LAWSON, JR.

***This easily-constructed test instrument is ideal for the beginner or the experimenter.***

**H**OW many times have budding repairmen or experimenters wished for a multimeter only to be stopped by its cost? "Is the plate voltage high enough?" "Is that resistor shorted?" Although many may not have the price of a factory-made volt-ohmmeter, those of you who have five or six dollars available may, by following these instructions, make a suitable meter. It is quite true, of course, that this model cannot compete with one of more expensive design, however, the unit constructed according to this article is a very useful instrument.

## Explanation of Schematic

First let us examine the circuit and its operation. In order to measure voltages,  $S_2$  is set so that probe 2 is connected directly to the rectifier thus eliminating the batteries 1, 2, and 3; resistors  $R_2$ ,  $R_3$  and  $R_4$ ; and the rheostat,  $R_1$ , from the circuit.  $S_1$  is set to one of the resistance ranges so that the maximum expected voltage will not exceed the current capacity of the meter. The method of determining the value of the resistances will be given later.

Since, in a circuit of constant resistance, the current produced is proportional to the voltage impressed, the same voltage will always produce the same current. With this known, the dial of the meter can be marked to represent voltages directly. The full-wave rectifier changes a.c. and

d.c. of the wrong polarity to d.c. of the correct polarity. Polarity of the meter must be observed because the meter moves in only one direction.

When measuring a.c. voltages, the value read on the d.c. scale will be the "average" value of a.c. rather than the "r.m.s." value. The "average" value must be multiplied by 1.1 to give "r.m.s.", or a separate scale may be added to the meter for r.m.s. voltages. Linearity may not be too good on the lower portion of the 10 volt a.c. range, but will be satisfactory on all other ranges.

To measure resistances,  $S_1$  is turned so that probe 1 is connected directly to the rectifier, and  $S_2$  is turned to that scale which will permit easiest reading of the expected resistance value. The probes are shorted, and the rheostat is adjusted so that the needle is over to the last mark on the scale.

When the probes are shorted, battery 1, 2, or 3, depending for which battery  $S_2$  is set, will create a current which goes through  $R_2$ ,  $R_3$ , or  $R_4$ ; the rheostat; the rectifier; and the meter.  $R_2$ ,  $R_3$  and  $R_4$  merely limit the current so that the meter will not be burned out. The rheostat adjusts the current to exactly the meter capacity. As you know, an external resistance inserted between the probes will decrease the current produced. This decrease can be measured and is the same for equal

resistances. Since the internal resistance is constant and the external resistance is variable, the ohm scales will not be linear. Instead, the divisions will become more crowded toward the left side.

The components needed to construct this instrument are given in the parts list. The probes are of the usual type and are easily obtainable. They should have needle points to facilitate their use. All resistors are inexpensive and standard. The rheostat is a 5000 ohm, 2 or 4 w. unit. The use of a low resistance, full-wave copper oxide rectifier in the circuit does away with an extra switch and an extra scale on the dial. It is also used to protect the meter for thus the polarity of the probes is always correct. A rectifier may be purchased to go with the meter, but in this case the over-all sensitivity with the rectifier connected must be 0-1 milliamperes. The fuse listed in the parts list, while not absolutely necessary, is recommended as further protection for the meter. If a fuse is used, its resistance must be subtracted from the values of the multiplier resistors, unless the meter is calibrated with the fuse in place, in



which case the resistance of the fuse may be ignored.

The values of  $R_2$ ,  $R_6$  and  $R_7$  are determined by means of Ohm's Law,  $R = E/I$ . Since on this meter maximum current is 1 milliamper,  $I = .001$ .  $E$  is the maximum voltage to be read on that scale whose corresponding circuit resistance is being calculated. Three voltage scales were selected, 10, 100, and 1000 volts. Substituting in the formula, we find that the total circuit resistance should be 10,000 ohms, 100,000 ohms, and 1 megohm. In very accurate work, the resistance of the meter would be subtracted from the calculated resistance to give  $R_2$ ,  $R_6$  and  $R_7$ , but since this meter was not designed for extreme accuracy, the values originally determined will be sufficiently exact.

Calculating  $R_2$ ,  $R_6$ , and  $R_7$  is done in the same way, with the exception that  $E$  is the voltage of the battery or batteries you are using. Using 1.5, 22.5, and 45 volts, the calculated resistances become 1500 ohms, 22,500 ohms, and 45,000 ohms. From these three resistances subtract about 500 to 1000 ohms apiece. A 1000 ohm potentiometer was tried first but was found to have not enough control over the higher voltage scales. A 5000 or even a 10,000 ohm potentiometer worked better.

### Construction

The actual construction of this meter will offer few difficulties. If a metal chassis is used the most difficult part, with ordinary hand tools, will be the cutting of the meter hole. As can be seen in the under-chassis view of the instrument, the flashlight cell is mounted internally, while the leads to the other battery are connected to a plug just outside of the chassis so that the large battery may be connected. The probe leads are brought in through a  $\frac{1}{4}$  inch hole in the side of the  $4 \times 8 \times 1$  inch chassis. A grommet or bushing is recommended in order to keep the insulation on the leads from wearing thin. Be sure to make the probe leads long enough. Two feet is not too long. Notice that no connections are made to the chassis. If connections were made to the chassis and one of the probes should touch the chassis, with the switch in the incorrect setting, it might ruin the meter.

A simple and neat way of marking the switch positions is to paint the chassis with a good grade of enamel in some dark color. After the paint has dried thoroughly, use a straight-edge and a stylus to cut the markings through the paint to the silvery chassis.

Calibration of this instrument is rather lengthy. First, the movement must be removed from the meter case or external meter cover. Several screws will usually need to be loosened or removed in order to release the movement. Extreme caution should be exercised in handling the move-

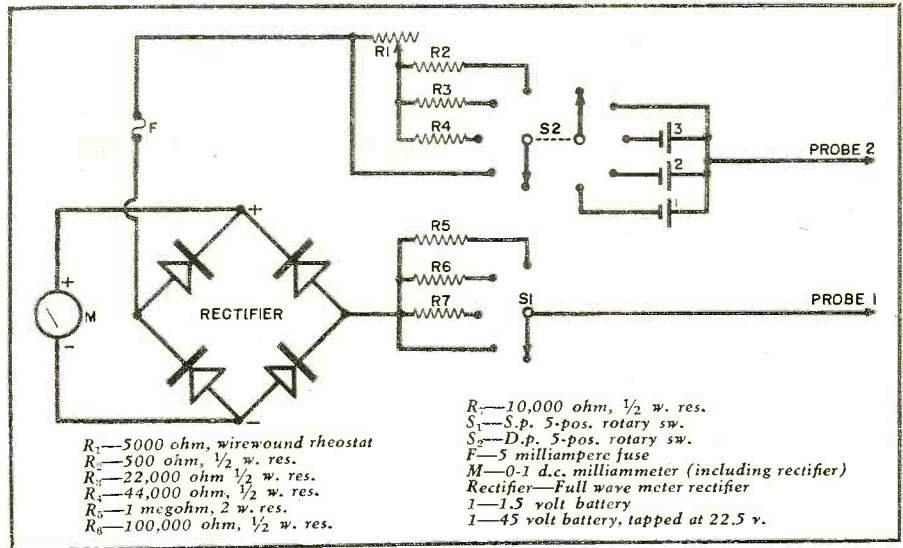

Circuit diagram of the low-cost, easily constructed, volt-ohmmeter.

ment so as not to injure any of the delicate windings, springs, or the needle which are exposed.

To calibrate the voltage scale use a fresh battery as a standard and determine what current is registered on the meter for that particular battery voltage. Make a table like that shown in this article of the voltages and currents produced by each. Use  $\frac{1}{2}$  volt intervals for the 10 volt scale, 5 volt intervals for the 100 volt scale and 50 volt intervals for the 1000 volt scale. Mark these voltages on the dial opposite the current produced. A good source of calibrating voltage consists of a potentiometer connected across a battery or other d.c. supply. Varying the potentiometer setting will vary the calibrating voltage.

In calibrating the ohm scales, the internal resistance of each circuit is adjusted to the proper resistance, as found in the calculation of  $R_2$ ,  $R_6$ , and  $R_7$ . Again a table should be prepared.

I=E/R					
R=10,000		R=100,000		R=1	
E in volts	I in ma.	E	I	E	I
.5	.05	5	.05	50	.05
1.0	.10	10	.10	100	.10
1.5	.15	15	.15	150	.15
2.0	.20	20	.20	200	.20
10.0	1.00	100	1.00	1000	1.00

Sample voltage chart used in calibration. R in right hand column is in megohms.

With this table, however, use a different form of Ohm's Law,  $I = E / (R + r)$ .  $E$  is constant for each scale as is  $R$ .  $I$  is the current produced in the circuit while  $r$  is the external resistance. Make a table listing every resistance you wish to measure for each scale and the corresponding current produced. Again mark the resistances on the dial, opposite the corresponding currents, and then carefully replace the movement in the case.

You now have an easy-to-use volt-ohmmeter at reasonable cost. —30—

Under-chassis view of volt-ohmmeter showing correct location of 1 1/2 volt battery.

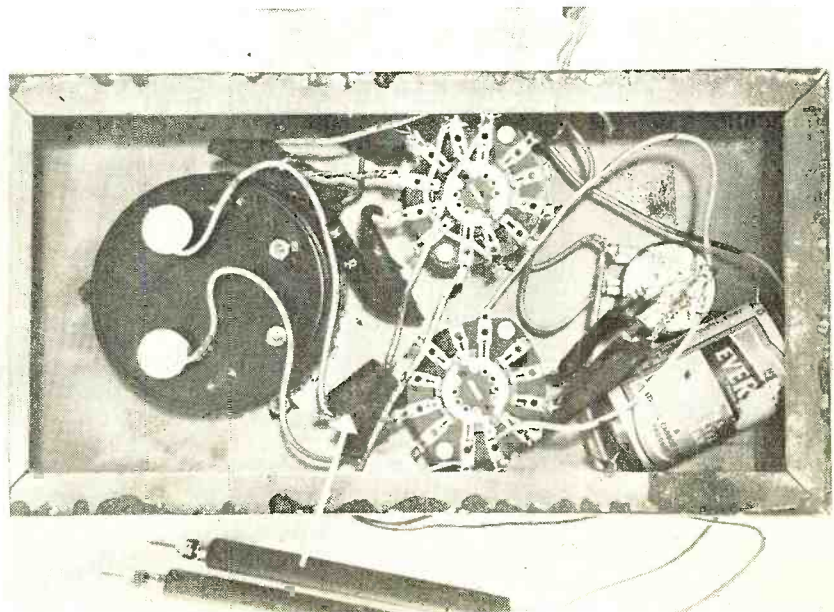

# Mac's RADIO SERVICE SHOP

By JOHN T. FRYE

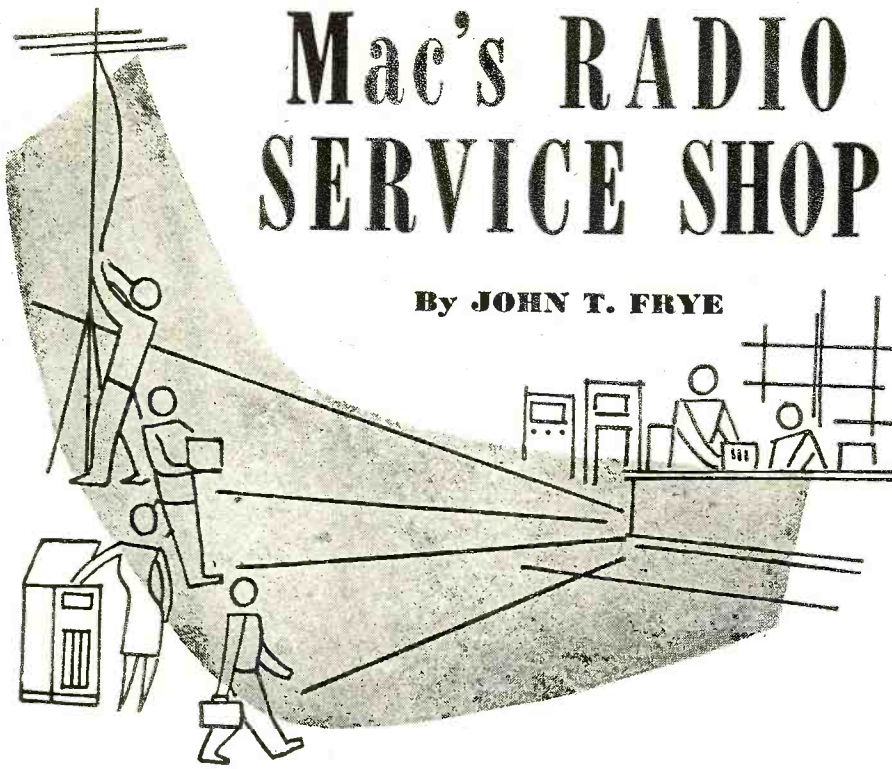

## BARNEY LEARNS ABOUT "PREVENTIVE SERVICING"

“KAY, you spider, a fly has just walked into your parlor!”

Mac turned around from the bench to see his good friend and fishing partner, Bill the barber, leaning against the door of the service department, a grin on his face and an a.c.-d.c. set beneath his arm.

“Well if it isn't the old clip-joint operator himself!” Mac said. “What's on your mind, butcher-boy? Don't tell me you are going to give me a chance to get back a few of those dollars I have paid you for what are laughingly known as haircuts.”

“Yes, now is your chance to get even for all three haircuts you got last year. I ought to have my head examined, but I decided to let you give Betsy here her annual check-up.”

“Any complaints?”

“Nothing much. When I first turn the set on, it sounds rather hoarse for the first half-hour; but then it gets all right. The tone quality might not be quite so good as it once was, but I am not sure.”

“Well, let's hope it is nothing trivial or inexpensive,” Mac said.

“If I know you, you old rosin-core robber, it won't be,” Bill called back over his shoulder as he went out the door; “and just remember that until I get that set back, I'll have nothing to listen to but the customers.”

As Mac put the set on the bench, Barney came out of the chassis-cleaning booth.

“Red,” Mac said, “lend me your big flapping ears for a few minutes. I want to show you what we do along the line of 'preventive service.' We will be having a good bit of that kind

of work for the next two or three months. Folks, like Bill here, will be bringing their sets in for a good going over before the winter programs start up.”

“Do lots of them bring their sets in for a regular check?”

“More and more of them are doing so. It is good insurance against having the set go dead at a time when it is particularly needed.”

“Can you make sure that will not happen?”

“No, neither I nor any other serviceman can make *sure* that some electrical part will not suddenly and unpredictably fail, but we can greatly decrease the likelihood of such an occurrence. Now you watch while I go over Bill's set; and whenever you work on a receiver that has been brought in for 'preventive service' you go through the same routine.”

“First,” Mac went on, “let's take up the complaints; he said the set was hoarse when he first turned it on and that the tone quality might be off a little. Let's listen.”

When the set was turned on, it began to play with normal volume; but the music sounded slightly rough, and speech did have a rasping quality.

“What do you think?” Mac asked with a quizzical look.

Before answering, Barney reached over and turned the volume clear off. A pronounced hum still came from the speaker.

“The input filter condenser, and possibly the others, are weak,” the boy said with conviction.

“Good boy!” Mac applauded. “Very often when the filters start to go on these little jobs, the condensers will

be low in capacity when they are cold but will gradually build up with a rise in temperature. That accounts for the hoarseness disappearing after the first half-hour. Always check the filters in these little sets and replace them if they are low in capacity or are leaky or are more than three years old. When you replace one section, replace them all; for all of the condensers are of the same age, and when one goes, the others will usually follow shortly.”

While he was talking, Mac had removed the old filter sections and had soldered in new ones. This took all of the hoarseness out of the set, but when the volume was advanced to slightly above normal, some distortion was apparent. The probe of the vacuum-tube voltmeter applied to the grid of the 50B5 indicated a few volts positive, and when the coupling condenser was cut loose from the grid prong, the condenser lead still showed a positive potential, indicating that the condenser was leaking voltage from the plate of the preceding stage. A new condenser was installed, and the volume remained undistorted almost to the full output of the set.

“The coupling condensers should always be checked for leakage—and so should a.v.c. bypasses—and they should be replaced if the slightest amount of leakage is present,” Mac said. “A leaky condenser in these spots can cause a lot of trouble, and the leakage always increases with time.”

“Now that we have taken care of his complaints, let's see what else we can find that may cause trouble,” the veteran serviceman said. He ran his finger lightly around the rim of the speaker cone, pushing inward just a trifle. When pressure was applied at one particular small arc of the rim, the music suddenly became muffled and distorted with even a very light pressure; but a comparatively heavy pressure could be exerted on other parts of the rim without this happening.

“The cone is out of alignment so that the voice-coil is nearly rubbing on the pole-piece on one side,” Mac explained as he loosened the spider-screws and inserted speaker shims evenly around the pole-piece. After the screws were tightened and the shims removed, the same pressure was required on any portion of the rim of the cone to make the voice-coil touch the pole-piece.

Next Mac ran a strong unmodulated signal into the antenna of the set and tapped all of the tubes lightly with a little rubber hammer. Then he turned it upside down and tapped the various coupling and bypass condensers. One condenser was found—a screen bypass—that made a rasping noise when it was tapped. This only happened when the unmodulated signal was passing through the set. Replacement of the condenser took care of this.

(Continued on page 142)

# MODERN TELEVISION RECEIVERS

By MILTON S. KIVER

## Part 6. Localizing troubles in television sound systems and proper servicing procedures to use.

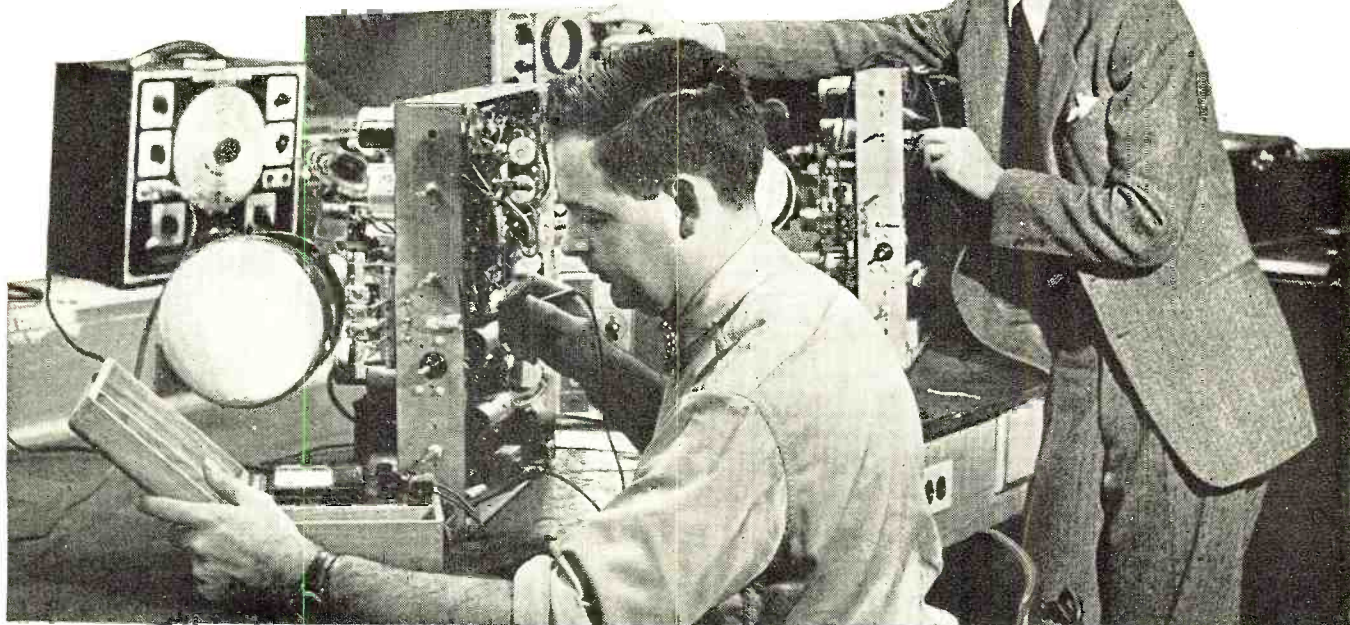

Many service organizations have the equipment and personnel qualified to handle television installations and repairs. Here Frank Krantz and Reginald Cherrill of the Witte Radio and Television Company, Philadelphia, check a couple of video receivers.

All television receivers can be divided roughly into three main sections—a video section, an audio section, and a composite signal section. The video section handles the video signal exclusively; the audio section handles the audio signal exclusively; and the composite section of the receiver handles both signals simultaneously. We have already noted that the two signals remain together through the r.f. system and one or more i.f. amplifiers, depending upon the design of the receiver. (Receivers employing the intercarrier system are not included in this discussion.) Consequently, if we obtain a bright clear image, we know that those stages containing both signals are functioning properly and up to the point of separation, the circuit contains no defect. Following this line of reasoning one step further, a distorted or absent audio output coupled with a good image can only mean that the trouble exists within the audio system.

A defect localized in the sound system of a television receiver is characterized by any of the following symptoms.

1. Picture is bright and clear but there is no audio.
2. Audio noisy but picture is clear.
3. Audio output distorted; picture unaffected.

Before proceeding, there is one important exception to be noted. In sets containing a fine-tuning control, the prescribed tuning procedure requires that the audio be brought in most clearly by adjusting the fine-tuning control. However, if the local oscillator frequency has drifted sufficiently, say several hundred kilocycles, it may be impossible to obtain a clear audio output with the fine-tuning control. In this case, adjust the oscillator trimmer or slug and note if any improvement is achieved. If both methods fail, it has been the author's experience that a distorted output means a defect in the sound system. Of course, if the audio system is completely quiet, these preliminary adjustments can be dispensed with and the audio system serviced immediately. However, for noisy, distorted, or weak audio outputs, with a clear picture, the adjustment of the fine-tuning control and receiver oscillator slug precedes any general servicing program.

When the serviceman has, from the above symptoms, decided that the defect is located within the sound system, there are several quick tests that can be applied before an extensive servicing procedure is undertaken. In many cases simple defects are quickly revealed, saving the serviceman considerable time. Probably the first test

is to check all the tubes in the sound system. These include the audio i.f., detector, and audio amplifiers. The best method is by substitution with tubes known to be good. A set of such check tubes should be kept separately and used *only* for testing purposes.

Many of the present television receivers combine AM and FM tuners together with television. This offers a second method for making a quick preliminary check. All services generally use the same audio system. If it is found that the set operates normally on the AM bands, but the audio output is distorted or missing when switched to television, then we can eliminate the audio amplifiers as the source of our trouble. This narrows down the search to the sound i.f. and detector stages.

Another item that can be discounted if a clear image is present is the low-voltage power system of the television receiver. (In the exceptional case, separate low-voltage supplies will be found for the audio and video systems. In these instances, the low-voltage system will require checking if the audio output is completely quiet.)

To obtain maximum benefit from the indications obtained during the preliminary testing, the serviceman *must* be familiar with the entire cir-

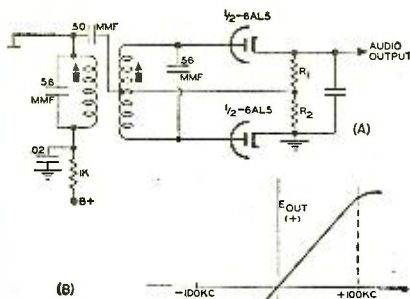

Fig. 1. (A) Foster-Seeley FM discriminator. (B) Response curve obtained with circuit.

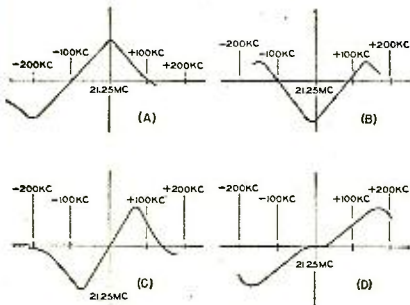

Fig. 2. The most common distortions of the S-curve indicating improper FM detector operation. (A and B) Primary of discriminator transformer misadjusted. (C) Response of S-curve too narrow. Adjust primary and secondary trimmers (or slugs) of discriminator transformer or, if this fails, replace entire unit. (D) Secondary of discriminator transformer is misadjusted.

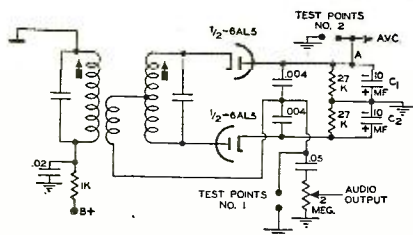

Fig. 3. A balanced ratio detector. The indications obtained at test points 1 and 2 are discussed in detail in the text.

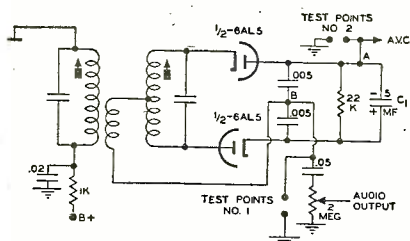

Fig. 4. An unbalanced ratio detector. See text for uses of the test points 1 and 2.

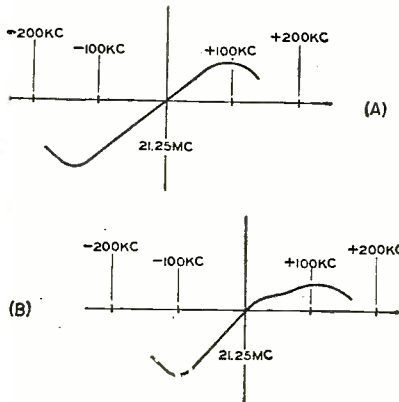

Fig. 5. The S-curve response when one diode in the FM detector has poor emission. (A) Emission slightly below normal and (B) when the tube emission is very low.

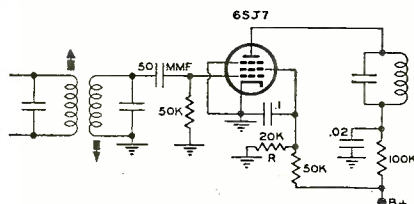

Fig. 6. A typical limiter inserted ahead of Foster-Seeley discriminators. If R should open up the complete limiting action will not be attained thus resulting in a noisy output on all but strongest signals.

circuit arrangement. It is here that a diagram showing, in block form notation, the path of the various signals through the set would be extremely useful. An auxiliary diagram showing the layout of the tubes and components on top and bottom of the chassis will also reduce the service time.

### Test Points in FM Systems

The preliminary tests are designed to reveal simple defects quickly. However, if no positive indication can be obtained, then a general servicing procedure is in order. Before we begin this process, let us carefully note each of the test point locations in a FM sound system because the signal indications obtained at these points will reveal considerable and valuable information concerning the circuit under test and do so with a minimum of wasted time.

a. *Sets containing Foster-Seeley Discriminators:* For the Foster-Seeley circuit, Fig. 1A, the response characteristic is an S-shaped curve. See Fig. 1B. This is viewed by placing an oscilloscope across both load resistors,  $R_1$  and  $R_2$ , and applying an FM signal to the grid of the stage preceding the detector. The useful section of this S-curve is its linear portion. This should extend for at least plus or minus 100 kc. about the i.f. value and in most television receivers will be plus or minus 300 kc. An AM signal generator, connected in parallel with the sweep generator, will provide marker pips and permit the extent of the curve to be determined. The condition of the S-curve is a sensitive indication of the ability of the FM detector to convert the incoming signal into distortionless audio voltage. The S-curve is thus an important test point of any FM detector. As long as the

curve deviates from this proper form, the output will be affected immediately. Fig. 2 shows several common distortions of the S-curve, their causes and remedies.

It is also possible to check the S-curve by placing a vacuum-tube voltmeter (instead of the oscilloscope) across  $R_1$  and  $R_2$ . Now, however, an AM signal generator must be used as the signal source. The meter readings are noted for various frequencies equally above and below the center i.f. The response is linear as long as frequencies equally above and below this center i.f. produce equal (but of opposite polarity) voltages on the meter. This method is more tedious than the previous method, but it can be used.

The Foster-Seeley discriminator is always preceded by a limiter. Since the voltage developed across the grid resistor of the limiter varies with signal amplitude, placement of a vacuum-tube voltmeter or oscilloscope across this resistor will indicate whether any signals are passing through the i.f. system. When two limiters are employed, the test point is shifted from the grid resistor of the first limiter to the grid resistor of the second limiter. Care should be observed to use the lowest readable signal in order not to drive the first limiter into saturation. With strong signals, the meter reading will remain steady for different input voltages and it will be impossible to properly check the alignment of the i.f. stages.

b. *Ratio FM Detectors:* Ratio detectors are either balanced or unbalanced and the method of using the test points afforded by this circuit varies with the arrangement of the detector. In the balanced circuit, Fig. 3, placement of an oscilloscope across test points No. 1 will produce an S-curve characteristic when an FM signal is applied to the grid of a preceding stage. The same two terminals can be used by a vacuum-tube voltmeter when an AM signal generator is connected to a previous stage. The method is similar to the one employed for the Foster-Seeley discriminator.

In the unbalanced ratio detector, the S-curve appears when an oscilloscope is connected to the test points No. 1. See Fig. 4. However, to check the linearity of this ratio detector using a vacuum-tube voltmeter, the following must be done. Connect two 68,000-ohm resistors in series across the 5  $\mu$ f. condenser, Fig. 4, and attach the common lead from the vacuum-tube voltmeter to the point between the 68,000-ohm resistors and the d.c. probe of the meter to terminal B. Now feed in signals having frequencies above and below the i.f. value and note the meter readings. Linearity will be determined by how many equal voltage readings but of opposite polarity are obtained for frequencies equally situated above and below the i.f.

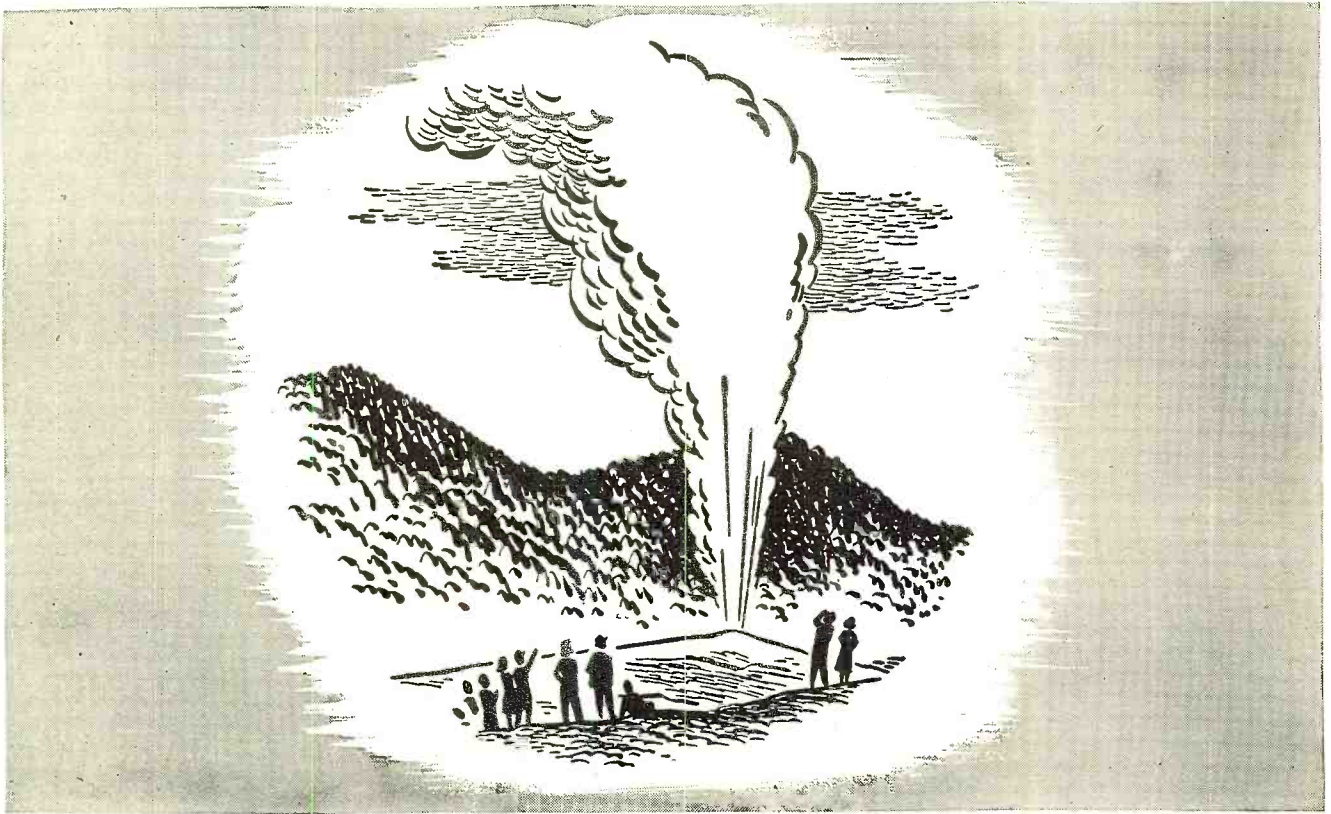

# Dependable . . .

The regularity with which "Old Faithful" sends its towering spray skyward has been a glowing symbol of dependability. And so it follows that the regularity of "Old Faithful" best typifies the dependability of RADIART VIBRATORS. Because they're built better . . . because they're engineered faultlessly, servicemen everywhere prefer Radiart everytime because they know that their customers receive greatest value consistently. They start . . . and start quickly! Their performance is dependable and above reproach. Just another feature in the long list of factors why Radiart is the preferred and fastest selling vibrator.

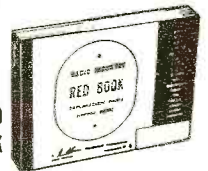

THE ONLY VIBRATOR LINE TO  
BE LISTED IN SAMS RED BOOK



## The Radiart Corp.

CLEVELAND 2, OHIO

# NEW YORK HEADQUARTERS FOR TRANSVISION

**Biggest Values in TELEVISION**  
**Easiest to Assemble—Lowest in Cost**

All prices are for complete kits with all parts, tubes, antenna, 60 foot lead-in wire.

Model No.	Description	Net Price
7	7" TV kit with wood front panel—5 channels.....	\$149.50
7BL	7" TV kit with table cabinet and built-in lens for 60 sq. in. picture—5 channels... with cab.	189.00
7PL	Same as 7PL, but with 13 channel TV/FM tuner—75 sq. in. picture.....	198.00
10FL	150 sq. in. picture TV/FM kit, complete with new all-angle lens built into a lucite frame—13 channels.....	249.00

Model No.	Description	Net Price
7CL	Same kit as 7BL—cabinet is console, 2-piece swing-top.....	199.00 with cab.
7PL	Same kit as 7BL—NEW ALL ANGLE LENS is built into lucite front panel—75 sq. in. picture.....	179.00
10BL	120 sq. in. picture—10" electro-magnetic TV kit with FM radio-lon Trap—prolongs life of tube—Table model walnut or blond, cabinet has built-in 15" lens—13 channels..... As Illustrated	299.00 with cab.

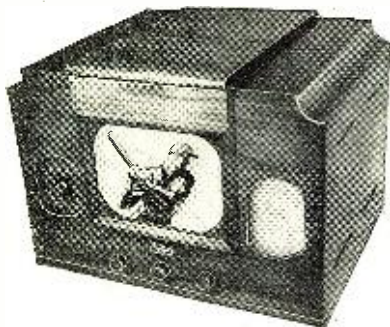

TV/FM kit with 13 channel tuner.  
 12" Standard..... 246.00  
 TV/FM kit with de luxe 13 channel tuner.  
 12" De Luxe..... 293.00  
 As Illustrated

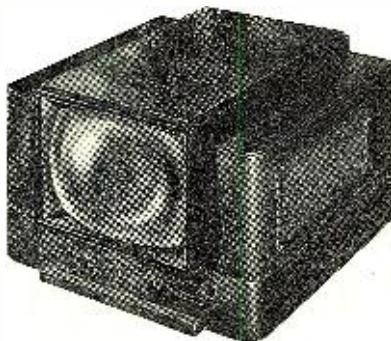

**TERMS**—10% net with order, balance C.O.D., or remit in full to save C.O.D. charges.

## DEALERS

Write in on your stationery for best dealer net prices.

# Radiomart

INC.

Store  
**149 Riverdale Ave.**  
 Yonkers  
 New York

Store & Warehouse  
**1919 Broadway**  
 (at 64th)  
 New York 23  
 New York

Phone  
 TRafalgar 7-4487

Test points No. 2 in the ratio detector are placed where the a.v.c. voltage is developed. See Figs. 3 and 4. This point may be considered as the counterpart of the test point in the grid circuit of the limiter stages.

When checking the alignment of the i.f. stages using an AM signal generator, a vacuum-tube voltmeter is connected to test points 2 (Figs. 3 and 4). (Note that the voltage polarity at point 4 is negative with respect to ground.) A voltage will appear at point 4 if a signal is able to pass through the i.f. stages. Test points 2 are thus useful for peaking i.f. coils.

If it is desired to check the alignment of the i.f. stages with a sweep generator, then the vertical terminals of an oscilloscope are connected across test points No. 2 but with the following precaution: Disconnect the electrolytic condenser connected from the a.v.c. point to ground. This is the top 10 µfd. condenser in Fig. 3 and the 5 µfd. condenser in Fig. 4. Now, connect the sweep generator to the control grid of the first i.f. stage and the response pattern for the i.f. system will appear on the screen.

The foregoing test points in each of the FM detector systems provide the serviceman with easy access into the respective circuits and help him track down defects simply and logically. The proper operation of an FM receiver is closely tied in with the correct alignment of all tuned circuits; any deviation from this condition will immediately result in audible distortion and seriously impair the ability of the FM system to combat noise and other interference.

## General Servicing Procedure

The general procedure for troubleshooting the audio system by means of signal tracing follows the same path pursued in AM sets, i.e., starting at the loudspeaker and working toward the front end of the receiver. In television sets, however, we need progress only back to the point where the video and audio signals were separated. The audio amplifiers are tested either by applying a 60-cycle (or other audible) note to the control grids of each audio tube or by placing a finger on each control grid socket terminal and noting whether hum is heard from the loudspeaker.

Next comes the FM detector. The best test to run on an FM detector is to observe its response or S-curve. Connect a sweep signal generator to the grid of the tube preceding the FM detector. Set it to sweep 300 kc. above and below the center i.f. Connect an oscilloscope across the output terminals of the detector and note the appearance of the S-curve. If distorted, check with Fig. 2 and correct accordingly.

Whenever the complete response curves are viewed on the oscilloscope screen, marker signals obtained from a separate AM signal generator should be used to identify mid-i.f. and the

**RADIO & TELEVISION NEWS**

## EASY TO LEARN CODE

It is easy to learn or increase speed with an Instructograph Code Teacher. Affords the quickest and most practical method yet developed. For beginners or advanced students. Available tapes from beginner's alphabet to typical messages on all subjects. Speed range 5 to 40 WPM. Always ready—no QRM.

**ENDORSED BY THOUSANDS!**

The Instructograph Code Teacher literally takes the place of an operator-instructor and enables anyone to learn and master code without further assistance. Thousands of successful operators have "acquired the code" with the Instructograph System. Write today for convenient rental and purchase plans.



**INSTRUCTOGRAPH COMPANY**

4711 SHERIDAN ROAD, CHICAGO 40, ILLINOIS

## A COMPLETE MANUAL ON TEST EQUIPMENT

Included in the Radio Data Book

Here you become acquainted with the designs and functions of all test equipment. All types of volt, current and ohmmeters, tube checkers, condenser meters, inductance meters, bridge measuring devices, RF signal generators, AF signal generators, signal tracers, distortion analyzers, test speakers, oscilloscopes, square-wave generators, frequency meters, field strength and tuning meters are explained and illustrated. From this section anyone working in electronics can determine the proper equipment for any particular job.

This is only 1 of the 12 sections in the RADIO DATA BOOK. 1148 pages, over 1000 illustrations. Order one today from your jobber or:

**\$5.00**

HOLLAND & BOYCE, INC., PUBLISHERS

MONTCLAIR 2,  
 NEW JERSEY

ACCLAIMED FROM  
COAST TO COAST



**GENERAL**  **ELECTRIC**

FIRST AND GREATEST NAME IN ELECTRONICS

179-238-8855

**PLEASE TEAR OUT THIS ADV. AS REMINDER**

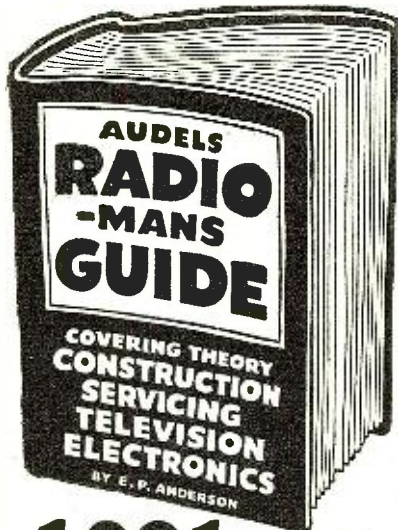

**1001 RADIO FACTS AND FIGURES**

**AUDELS RADIOMANS GUIDE**—914 Pages, 633 Illustrations, Photos, Wiring Diagrams, 38 Big Chapters, covering Radio Theory, Construction, Servicing, including Important Data on Developments in Television, Electronics and Frequency Modulation, Review, Questions and Answers, Calculations & Testing. Highly Endorsed—Indispensable for Ready Reference and Home Study.

**\$4 COMPLETE • PAY ONLY \$1 A MONTH**  
Step up your own skill with the facts and figures of your trade. Audels Mechanics Guides contain Practical Inside Trade Information in a handy form. Fully illustrated and Easy to Understand. Highly Endorsed. Check the book you want for 7 days' Free Examination.

Send No Money. Nothing to pay postman.

**CUT HERE MAIL ORDER**

**AUDEL, Publishers, 49 W. 23 St., NEW YORK 10, N. Y.**

Please send me postpaid for FREE EXAMINATION books marked (\*) below. If I decide to keep them I agree to mail \$1 in 7 Days on each book ordered and further mail \$1 monthly on each book until I have paid price—otherwise, I will return them.

- RADIOMANS GUIDE, 914 Pages** . . . . . \$4
- ELECTRICIANS EXAMINATIONS, 250 Pages** . . . . . 1
- WIRING DIAGRAMS, 210 Pages** . . . . . 1
- ELECTRIC MOTOR GUIDE, 1000 Pages** . . . . . 4
- ELECTRICAL DICTIONARY, 9000 Terms** . . . . . 2
- ELECTRICAL POWER CALCULATIONS, 425 Pgs.** . . . . . 4
- HANDY BOOK OF ELECTRICITY, 1440 Pages** . . . . . 4
- ELECTRONIC DEVICES, 216 Pages** . . . . . 2
- ELECTRIC LIBRARY, 12 vol., 7000 Pgs., \$1.50 vol.** . . . . . 2
- OIL BURNER GUIDE, 384 Pages** . . . . . 1
- REFRIGERATION & Air Conditioning, 1280 Pgs.** . . . . . 4
- POWER PLANT ENGINEERS Guide, 1500 Pages.** . . . . . 4
- PUMPS, Hydraulics & Air Compressors, 1658 Pgs.** . . . . . 4
- WELDERS GUIDE, 400 Pages** . . . . . 1
- BLUE PRINT READING, 416 Pages** . . . . . 2
- SHEET METAL WORKERS Handy Book, 388 Pgs.** . . . . . 1
- SHEET METAL PATTERN LAYOUTS, 1100 Pgs.** . . . . . 4
- AIRCRAFT WORKER, 240 Pages** . . . . . 2
- MATHEMATICS & CALCULATIONS, 700 Pgs.** . . . . . 2
- MACHINISTS Handy Book, 1600 Pages** . . . . . 4
- MECHANICAL Dictionary, 968 Pages** . . . . . 4
- AUTOMOBILE GUIDE, 1700 Pages** . . . . . 4
- DIESEL ENGINE MANUAL, 400 Pages** . . . . . 2
- MARINE ENGINEERS Handy Book, 1280 Pages** . . . . . 4
- MECHANICAL DRAWING GUIDE, 160 Pages** . . . . . 1
- MECHANICAL DRAWING & DESIGN, 480 Pgs.** . . . . . 2
- MILLWRIGHTS & Mechanics Guide, 1200 Pgs.** . . . . . 4
- CARPENTERS & Builders Guides (4 vols.)** . . . . . 6
- PLUMBERS & Steamfitters Guides (4 vols.)** . . . . . 6
- MASONS & Builders Guides (4 vols.)** . . . . . 6
- MASTER PAINTER & DECORATOR, 320 Pgs.** . . . . . 6
- GARDENERS & GROWERS GUIDES (4 vols.)** . . . . . 6
- ENGINEERS and Mechanics Guides** . . . . . 6
- Nos. 1, 2, 3, 4, 5, 6, 7 and 8 complete** . . . . . 12
- Answers on Practical ENGINEERING** . . . . . 1
- ENGINEERS & FIREMANS EXAMINATIONS** . . . . . 1

Name \_\_\_\_\_  
 Address \_\_\_\_\_  
 Occupation \_\_\_\_\_  
 Employed by \_\_\_\_\_ RN

end frequencies of the linear section of the curve. When a sweep signal generator is not available and the tests must be made using an AM signal generator, the process is lengthened considerably because we can only test one point at a time. The procedure, in this instance, has already been given in detail in a previous article.

In these FM detectors the two diodes should be matched fairly closely. If one detector diode has low emission, the S-shaped curve will now assume the appearance shown in Fig. 5. This condition results in poor noise rejection at low signal inputs and sound distortion at high signal inputs. When both discriminator diodes have low emission, the sensitivity of the receiver is poor and even normally good signals are heard against a background of noise.

**Checking Limiters**

When a receiver which has been operating normally suddenly becomes noisy, the discriminator tubes and alignment should be checked. If the receiver contains a limiter stage, this too should be checked. Limiters become noisy when their grid-leak circuits open up, or the voltages applied to the electrodes rise above normal. In many circuits, low voltages for the screen and the plate are obtained by the voltage divider arrangement shown in Fig. 6. If *R* should open up, the voltage applied to the screen will rise. Under these conditions it will require a considerably stronger signal to bring the tube to saturation and the limiting action of the tube is impaired. Ordinarily, most limiter tubes will saturate with input signal voltages of 2 volts or more. The best method of testing the limiter is to measure its grid, screen and plate voltages and check these against the values recommended by the manufacturer.

A noisy receiver containing a ratio detector can usually be traced either to improper alignment of the detector or an open electrolytic condenser in the detector (*C*<sub>1</sub> and/or *C*<sub>2</sub> of Fig. 3

or *C*<sub>1</sub> of Fig. 4). This condenser, together with its shunting resistor, stabilize the ratio detector against amplitude modulation of the received carrier. If the condenser becomes defective, noise will ride through and be heard. The serviceman will find that sets using the ratio detector will receive weaker signals with less background noise than the same signal in a set possessing the Foster-Seeley discriminator. In the latter receiver, noise disappears only when the preceding limiter is driven to saturation, but no such "threshold" effect is apparent in the ratio detector. However, in all instances, when the noise or interference is stronger than the signal, the noise will prevail.

**The Intermediate Amplifiers**

A rapid check of the i.f. system, to determine whether signals can pass through, can be made in the following manner. For receivers using the Foster-Seeley discriminator, connect a vacuum-tube voltmeter across the grid-leak resistor in the limiter. Connect the output lead of an AM signal generator to the signal grid of the mixer tube. The ground lead of the generator is attached to the receiver chassis. Set the signal generator to the i.f. value of the circuit. If the i.f. system is functioning, the vacuum-tube voltmeter needle will deflect. If the signal path is broken at any point, moving the generator toward the limiter will soon reveal the defective stage. An ordinary voltage and resistance check should narrow down the search to the component itself.

In sets using a ratio detector there are no limiters. In these instances, place the v.t.v.m. at test points 2, Figs. 3 and 4. The same indications will now be obtained as with the meter in the limiter grid circuit.

It cannot be stressed too strongly that for optimum results in the shortest time, the serviceman must be familiar with the layout of the parts on the receiver chassis and the signal path through the receiver.

*(To be continued)*

The problem of the high cost of putting an FM station on the air has been met by Station WOPT-FM of Oswego, New York. A low-cost Quonset hut, 40 by 60 feet, was adapted to house the transmitter, the radio station's offices, and studios. The floor area provides for foyer and lounge, three studios, engineer's room, music library, control room, information office, newscast and teletype room, manager's office, utility room, service area, program director's office and the rest rooms. Quonset huts are now being used by many stations in various parts of the country.

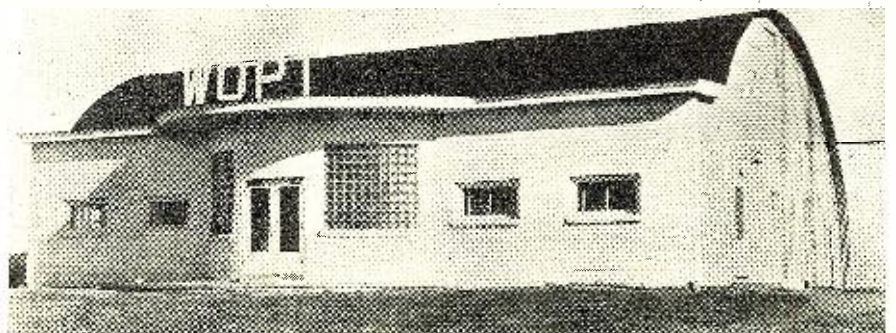

**RADIO & TELEVISION NEWS**



**DETROLA CHANGER**  
\$12.95 2 for \$25.00

Detrola Changer. Base size 1 1/2 x 12 inches. \$12.95. Two for \$25.00. Aero Changer. Base size 12x13 inches. \$12.95. VM-800 Changer. Base size 13x14 inches. \$14.95.



General Instrument changer. Base size 10 1/2 x 12". \$16.95. Seeburg, triple post. World's best. Base size 14x14 inches. \$37.95. Made to fit leatherette bases for above changers. \$1.95. Specify type of changer for base.

REPLACEMENT MOTOR FOR CHANGER.....\$1.49

**1948 MODEL—MIKE-BROADCASTER**  
ONLY \$7.95

Broadcasts 800 to 1500 KC from either a phonograph pick-up or a crystal or dynamic mike. Makes any radio receiver a P.A. system, record player or recording amplifier. Gives broadcast quality. Has faster control from mike to record, simulating a regular broadcast station. This is a powerful model; using 2-251A, 128J7 and 35Z5 tubes. Priced with tubes and connecting instructions. Works on 110 volts AC-DC. Crystal mike and desk stand \$4.95 extra. Model DE-5 truly a de-luxe mike-phonoscillator.



**3-TUBE PHONO. OSC. ONLY \$4.95**



Model DE-4—Phonograph oscillator. Broadcasts from 800 to 1500 KC. Gain for any crystal pick-up. A new powerful circuit is used to assure plenty of power. Has variable gain control for proper modulation. Priced with tubes ready to operate. Two 50B5 and 34W4.

Model DE-4 Net.....\$4.95

**SUPERHET BROADCAST TUNER**



for connection to phono amp. or P.A. system. Compact chassis 5 1/2 x 12 x 3 inches. May be mounted inside the record player cabinet. Requires only three connections to amplifier. Uses 68A7 or 128A7; 68K7 or 128K7 and crystal diode. Complete with tubes, loop antenna, dial and instructions for connecting to any amplifier. Net \$7.95. Specify if tuner is to be used with AC or AC-DC type amplifier.

**G. E. VARIABLE RELUCTANCE PICK-UP AND PRE-AMP \$6.95**

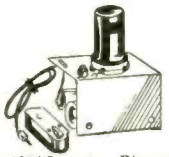

Scop—Pre-amplifier for General Electric Variable Reluctance pick-up. Easily connected to any AC or AC-DC amplifier. Wired and Tested with 68C7 or 128C7 tube. Diagram for connections is furnished. Specify whether you want pre-amplifier for AC or AC-DC use. Net price. Pre-amp. with Tube and G. E. Pick-up—\$6.95.

**FM-TUNER**

Top quality FM tuner for 88 to 108 MC. This is a ratio detector type. A full superhet, not a regenerative gadget. This one works or your money back. Stock No. FR-88. Net Price.....\$20.45



**12 FOR \$2.39**

Permanent phono needles. Save 75% on permanent needles. Regular \$1.00 retail seller. We bought 50,000 from a phono manufacturer, at a great loss; your gain 2,000 play precious point needle. 12 for \$2.39. Worth \$6.00.

**REPLACEMENT CARTRIDGES**



L-72 High-Output (8-5 volts) Replacement cartridge for "one lump" amplifier. Scoop price \$1.49, 10 for \$13.00. American Replacement cartridge fits 95% of all tone arms. Replaces L-26 Astatic, etc. Net \$1.29, 10 for \$11.95. L-70 cartridge \$1.49. Shure or Astatic manufacturers type pick-up with normal output. (1 volt). Cartoned \$1.95. General Industries Heavy Duty Phono Motors. Brand new. Model RM-4. 78 RPM. best phono motor to date. \$7.95. Standard Alliance phono motor. rim drive with turntable \$2.95. Our Leader phono motor. rim drive, with turntable, top quality \$1.98. Replacement phono motor. fits 75% of all automatic changers \$1.49. 2 for \$2.79.

**GET ON OUR MAILING LIST**

Drop Us a Post Card Now—for our Latest Bargain Flyer.

**50,000 TUBES**

Guaranteed Standard Brand 1st Grade  
49c EACH 100 FOR \$45.00

PICK TYPES FROM LIST BELOW

35A5	7E5	7F7
50A5	7E7	7N7
35Y4	7H7	7C5
14A7	7C7	7Z4
14B6	7B6	7Y4
14Q7	7A7	

**BRAND NEW**

**BC-645**

9.95 Two for 19.00

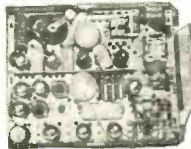

A small complete Transmitter and superhet receiver, for the 450 megacycle band. Diagrams for building AC power supply and conversion furnished. Ideal for MCW, CW or phone. The tubes (4-717, 4-717, 2-710, 2-6F6, 2-9Z5 and WE-316A) are worth more than our sale price. BC-645 I.F.F. unit \$9.95 each. Two for \$19.00. Extra WE-316A tube 99c. 12 volt DC dynamotor (furnished all power) \$2.95. BC-645 shipping weight 25 lbs.

**ARC 4 TRANSMITTER AND RECEIVER**

For operation VHF frequencies in range of 140-144 mc. Four channel crystal controlled. Manufactured by Western Electric—24V operation. Complete with crystal and dynamotor. Used. Good condition.....\$14.95

**BC-733 D LOCALIZER RECEIVER**

Freq. 108-110 Mc; Tube complement; 10 tubes—1-128Q7, 2-128R7, 1-12A6, 1-11A7GT, 2-128Q7, 3-717A. New. NOW ONLY.....\$7.95

**15" 1000 OHM FILT \$3.95**

Nationally known make—15" 1000 ohm speaker. 1 1/2" 16 ohms voice coil. Will take 25 watts. Factory cartoned, fully guaranteed. Stock No. 15VZ. NET \$13.95. Two for.....\$26.50

- 5 tube BC-1206 Beacon Receiver. 195-420 KC. New. Factory cartoned.....\$ 5.95
- SC-118A Airmeter complete. New factory cartoned..... 29.50
- AM-61A 15 tube indicator amplifier. New with tubes..... 9.95
- Carbon hand mike, with push switch 99c. 10 for L-81-A 2" Selsyn indicator \$2.45. 2 for..... 4.45
- BC-654 Transmitter-receiver. Good condition..... 12.95
- BC-458, 5 to 7 MC Command transmitter, new in factory cartons..... 6.95
- BC-454, 3 to 6 MC Command receiver, with tubes. New factory cartons..... 5.95
- New BC-456 Modulator, with tubes, less dynamotor..... 2.95
- Used BC-456 Modulator, with tubes and dynamotor..... 2.90
- Command set Antenna current meters. Used \$1.95. 2 for \$3.50; New \$2.95. 2 for..... 5.50



R.C.A. Two-Station Intercom. It has Amplifier made separate, to reduce size of stations; housed in plastic case, trimmed with chrome. Low distortion produces natural voice reproduction. Ease of installation makes this unit ideal for home, office or store. Complete with amplifier, two stations and 100 ft. wire.

\$19.95

**FM-AM CHASSIS 9 TUBES—\$59.95**

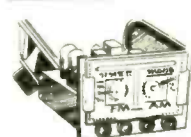

Garod 9 tube PM and AM chassis. Covers 88 to 108 MC and 550 to 1600 KC. Twin dials easily installed in cabinet. Factory wired and tested, with tubes and 5" speaker. Use with any larger PM speaker. Buy this deluxe chassis for the price of a good FM converter. Model FX-23. Net \$59.95. Cinna-dragraph, heavy duty Alnico V magnet PM speaker, 12". \$6.95, extra.



**14-WATT AMP. \$29.95 THIS AMP. SHOULD SELL FOR \$50.00**

Here is a high fidelity amplifier scop we may never be able to offer again. Licensed under Western Electric patents. Brand new factory cartoned. 14 watt average output; 25 watt peak output. Matches 4-8-16 or 500 ohm line. Complete with tubes 68L7, 68N7, 2-128L7, 2-6V6GT and 5Y3. Designed for 110 volt AC, 60 cycle operation. Frequency response 50 to 12,000 CPS. Hum level down 69 DB. Gain for two mikes and one phono pick-up. Eastern amplifier. Model E14A.....Net \$29.95 Model E25A. Same as model E14A, except it has 2-6L6 output tubes, giving 30 watts output....Net \$44.95

Clark 14 watt amplifier. Has input for mike and phono. Factory built, less metal top. While they last \$22.95. An unbeatable value. Stock #CK1-10.

**COMPLETE WIRE RECORDER \$69.95**

Portable Wire Recorder Model GN-11

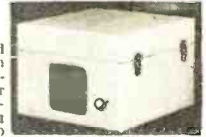

Has ready wired and tested 5 tube AC type amplifier with push-pull 6V6 tubes. Built-in eraser circuit. Input for crystal mike or phono pick-up. Diagrams show how you can record from any radio receiver. 2 position switch enables you to quickly change from record to playback or conventional P.A. system. This amp delivers 12 watts of good clean audio. Here is what you get: Webster 79 recording mechanism, with 15 minute spool of wire, attractive leatherette covered case. 6" heavy duty PM speaker and wired and tested 12 watt AC wire recording amplifier. All you do is mount the amp, recording mechanism and speaker. Simple instructions furnished. Portable Recorder Model GN-11 Net \$69.95. Crystal mike \$4.95 extra.

Deluxe Portable Wire Recorder Model GN-12. Has same features as the model GN-11, as well as a larger split type leatherette covered case and a heavy duty 10 inch PM speaker. Deluxe Portable Wire Recorder Model GN-12. Net \$79.95. Crystal Mike \$4.95, extra. Recording Wire. 15 minute spool \$1.30. 30 minute spool \$1.95. 1 hour spool \$3.25.

**COMPLETE DISC RECORDER \$39.95**

78 RPM Disc Recorder. The best value in America, today. Makes records from mike or radio. Has a beautiful tan case, leatherette covered. Size 8x13x6 inches. 78 RPM, R-70L General Industries record playback mechanism and wired and tested recording amplifier (Push-pull 50L6 output, 4 tubes plus rectifier). 5 inch Alnico V PM speaker. You get all material for recorder; nothing else to buy. Only a few minutes time required to mount the amplifier. R-70L and speaker in the case. A \$70.00 value with easy to follow instructions. Net Price \$39.95. This recorder offered as single speed (78 RPM) unit. The case will not accommodate the dual speed mechanism. 33 1/3 RPM is not successful on this type of unit.

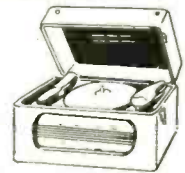

**SCOOP — WIRE RECORDER \$59.95**

Scoop. A complete portable wire recorder and playback offered in the same case as the disc recorder model KD-3 described above. Has all the features of model GN-11 except is furnished with a wired and tested push pull 50L6 amplifier. This unit has the same features as nationally advertised wire recorders selling for twice our price. Shipped with major components unmounted. Model TR-49 net \$59.95.

**PORTABLE RECORD PLAYER \$13.95**

Deluxe single record player with 3 tube wired and tested amplifier and 4 1/2 pm. In same case as model KD-3. Latest motor and pickup. Shipped with components unmounted stock no. DV-14. A \$25.00 value for only \$13.95.

**VOLT-OHM-METER \$29.95**



Jackson Model 643, new condition, push-button type Volt-Ohm-Meter. 1000 ohms per volt sensitivity. Measures volts AC or DC to 1000 in 5 steps. Ohms, low medium and high ranges. 3 mil scales. A scoop at only \$29.95.

**CLASSIFIED BARGAIN LISTINGS**

- 100 assorted 1/2 watt carbon resistors. All popular sizes. \$0.79.
- 2 watt neon lamp. Same base as a regular house light bulb. 110v for nite light. \$0.39.
- Philmore crystal radio receiver, for broadcast band \$1.49 value \$0.89.
- Universal antenna, RF or oscillator coils. Made by Eagle. Buy these and match any condenser gang. Choice, each \$0.73.
- Walco Universal dial belt. A 3-foot length, enough for several dials. Installed without dismantling the dial mechanism. \$0.90.
- Battery booster (charger), 4-2 amp tapering charge. A handy item for the shop, to keep your test battery up. \$5.95.
- Loop antennas, as used on popular AC and AC-DC radios. 3 sizes: small, medium and large. Your choice, \$0.39.
- Phono Motor for record changers. Fit 75% of all changers built. Rated about 1/100 horsepower. 110 volt, 60 cycle. Ideal for experimenters, etc. \$1.49 each; 2 for \$2.79.
- Spaghetti tubing, small package of 8-inch lengths, assorted sizes. Package \$0.19.
- Grid cloth in a cellophane dustproof package. A handy shop item. 18 x 20" \$0.75; 12 x 12" \$0.36.
- Grid cloth, light weight, grey, 48" wide. \$1.49 per yard.
- 61.6 Metal RCA tubes. A little rusty, but new and perfect. Special, \$0.49; 10 for \$4.50.
- 128G7 RCA tubes, rusty but perfect. Special, \$0.19; 10 for \$1.90.
- 8-foot G.E. plastic AC line cord, with lifetime plug. Special, \$0.24; 10 for \$2.00.
- Matched set of coils and condenser gang. Includes 2 I.F.'s, condenser gang, loop antenna and oscillator coil. Special, \$4.95.
- 45G I.F. transformers, 1" can. Leitz wound. Special, per pair \$0.75.
- Iron core peevce I.F. transformers. 456 KC; as used in personal portable sets. Per pair, \$0.98.
- Hot special in toggle switches. Single P8T, 1/4" shank. \$0.22; 10 for \$2.00. DPST 1/4" shank. \$0.23; 10 for \$2.50. DPDT 1/4" shank. \$0.39; 10 for \$3.50.
- New cartoned RCA 6L6 Metal tubes. Special, \$1.29; 10 for \$11.00.
- 38/62 Division Lead Co. Rosin core solder. Hot Special, 1 lb. spool, \$9.49.
- Bakelite Fuse holders, Panel mounting. Special, \$0.15.
- Bakelite cased jewels, turns to dim. A \$1.00 value; panel mount. Special, \$0.19; 10 for \$1.50.
- 3 or 4 wire oscillator coils. Special, \$0.19; 10 for \$1.50.

**McGEE RADIO COMPANY**

WRITE FOR CATALOG  
PRICES F.O.B. K. C.

SEND 25% DEPOSIT—BALANCE C.O.D.  
1225 McGEE ST., KANSAS CITY, MISSOURI

September, 1948

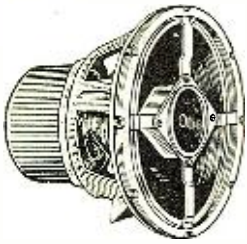

★ SALE ★  
**12 inch COAXIAL**  
 PERMANENT MAGNET SPEAKER  
**\$12<sup>95</sup>** each  
 TWO FOR \$25.00

- ★ BRAND NEW NETWORK
- ★ FACTORY CARTONED ALNICO V MAGNET VALUE IN AMERICA
- ★ BUILT IN MATCHING BEST SPEAKER

Designed by one of America's finest speaker builders, for FM high fidelity radios, record players and P.A. systems. This speaker is incorporated in radios selling in the \$50.00 bracket. It is a specially designed 12" Alnico V magnet PM, with built-in Alnico V tweeter. The high-pass filter is concealed under the pot cover. Just hook to any 8 ohm output transformer. (Will hook in place of any house radio speaker, as most speakers have 8 ohm voice coils), only two wires to connect. Will handle approximately 18 watts. This co-axial PM speaker should sell for \$35.00. Why buy an ordinary speaker, when we are offering a co-axial Alnico V PM for only \$12.95? Latest 1948 production, not surplus, fully guaranteed. Stock No. 4-12X. Weight 8 lbs.



★ OUR LEADER ★  
**12" COAXIAL**  
 PM SPEAKER  
**\$9<sup>95</sup>** TWO FOR \$19<sup>00</sup>

Model 12-RN—Our leader 12" coaxial PM speaker, with 3" tweeter. Equal to above model 4-12X except tweeter will not respond to as high a frequency. Matching network is built-in; hook to any 8 ohm output. Will take 15 watts. Weight 12 lbs. Net \$9.95, 2 for \$19.00.

**8-WATT AMPLIFIER WITH P.P. 50B5 \$9.95**



4 tube, plus rectifier, AC-DC amplifier. Push-pull 50B5 output tubes, with 12S77 (Gain for mike or G.E. variable reluctance pickup), 12SL7 (Gain for conventional crystal pick-up) and phase inverter. This is a nice small audio amplifier, with tone and fader control, plus inverse feed-back. Finished wired and tested, complete with tubes, 8 watts output. Ready to play. Weight 6 lbs. Model TM-5. Net price \$8.95. Crystal mike and desk stand \$4.95 extra. 3" PM speaker \$2.95 extra. G.E. variable reluctance pick-up cartridge \$4.69 extra.

**BINGO P.A. SYSTEM \$14.95**

Bingo Amplifier, \$14.95. A complete portable public address system, with inputs for microphone and phono pick-up. We offer the above 8 watt push-pull 50B5 amplifier in an attractive leatherette case with large 8" built-in speaker for only \$14.95. This bingo amplifier is ideal for paging and announcing work. Stock No. BG-4. Weight 14 lbs. Net \$14.95. Crystal mike and desk stand, \$4.95 extra.

**\$59.50 VALUE MUSICAL AMPLIFIER WHILE THEY LAST \$24.95**

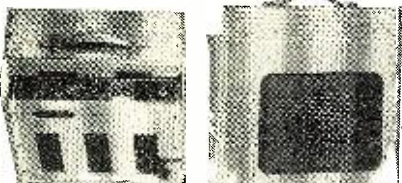

8 watt musical amplifier, 4 tube AC type. Inputs for crystal or dynamic mike and phono or instrument pick-up. 2 gain controls and tone control. Has heavy duty built-in 8" speaker. Attractive leatherette covered case. Made by a large manufacturer to sell at \$59.95. Brand new, fully guaranteed. For 110 volt AC operation. Our scoop price, \$24.95. Stock No. XR-3. Contact instrument pick-up, \$6.95 extra. Deluxe instrument pick-up; with volume control, \$8.95 extra. Crystal mike and desk stand \$4.95. Shipping weight, 20 lbs.

**3-TUBE MUSICAL AMP. \$19.95**

In same deluxe case as the model XR-3 shown above. Has same features except it is designed for instrument pickup only. No input for mike. Stock No. XR-22. Net \$19.95.

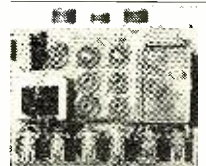

**SCOOP! \$1.49**

Auto pilot amplifier salvage scoop. Has 6 high resistance relays that operate in tube plate circuits on less than 8 mills. Also 4 controls. Choke cond., etc. Less tubes. Used but in good condition. Weight 12 lbs. Stock No. C-1T. Net \$1.49; two for \$2.49.

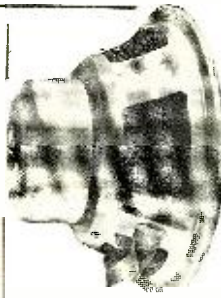

**SCOOP!**  
**15 in. ALNICO V \$2<sup>95</sup>**  
 PERMANENT MAGNET  
**JUKE BOX SPEAKER TWO FOR \$23.95**  
 ★ NEW—FACTORY CARTONED ★ GUARANTEED

★ THE 15" SPEAKER OF THE YEAR  
 of all time. Made by a nationally known builder of fine speakers. A full 15" 12 1/2 oz. Alnico V Permanent magnet speaker of juke box quality. Has standard 8 ohm voice coil. Will take up to 18 watts average or 25 watts peak. Here is a speaker that will bring out those low notes. Latest 1948 production; not line through-outs. Every speaker is guaranteed perfect. We may not be able to continue this offer for long, so place your order now. Stock No. 15-KR, weight 11 lbs. A \$35.00 value for only \$12.95.

**SUPER 15" P.M. \$19<sup>95</sup>**

Model 15-LS 15" PM speaker; same as 15-KR except has 2 1/2 oz. Alnico V magnet and will take 30 watts peak audio. Fine for public address use. Weight 12 lbs. Net price, \$19.95.

**MAGNAVOX P.M. SPEAKER SALE**

- 5" Magnavox 8 Oz. Alnico 3 magnet PM. . . . \$ 1.79
- 6" Magnavox 12 Oz. Alnico 3 magnet PM. . . . 10 for 15.00
- 6" Magnavox 12 Oz. Alnico 3 magnet PM. . . . 2.25
- 8" Magnavox 12 Oz. Alnico 3 Magnet PM. . . . 5 for 10.00
- 8" Magnavox 12 Oz. Alnico 3 Magnet PM. . . . 3.25
- 10" Magnavox 20 Oz. Alnico 3 magnet PM. . . . 5 for 15.00
- 10" Magnavox 20 Oz. Alnico 3 magnet PM. . . . 4.95
- 12" Magnavox 20 Oz. Alnico 3 magnet PM. . . . 5 for 22.50
- 12" Magnavox 20 Oz. Alnico 3 magnet PM. . . . 5.95
- 12" Magnavox 20 Oz. Alnico 3 magnet PM. . . . 5 for 25.00

**POPULAR ALNICO V P.M.'s AT NEW LOW PRICES**

- 3" 1 oz. Alnico V magnet PM speaker. . . . \$0.99
- 4" 1 oz. Alnico V magnet PM speaker. . . . .99
- 5" 1 oz. Alnico V magnet PM speaker. . . . .99
- 5" 1.47 oz. Alnico V magnet PM speaker. . . . 1.19
- 5" 2.15 oz. Alnico V magnet PH speaker. . . . 1.49
- 6" square 1.47 oz. Alnico V magnet PM. . . . 1.49
- 6" square 2.15 oz. Alnico V magnet PM. . . . 1.95
- 4 1/2" 1.47 oz. Alnico V magnet PM speaker. . . . 1.49
- 6 1/2" 3.15 oz. Alnico V magnet PM speaker. . . . 2.58
- 12" 7 oz. Alnico V 18 watt PM. Net. . . . 4.95
- 10" 7 oz. Alnico V 18 watt PM. Net. . . . 4.45
- 10" 4 oz. Alnico V 12 watt PM. Net. . . . 3.95
- 4" 450 ohm field speaker. . . . 1.89
- 5" 450 ohm field speaker. . . . 1.89
- 5" 4 ohm field auto speaker. . . . 2.49
- 6 1/2" 450 ohm field speaker. . . . 2.49
- 6 1/2" 1000 ohm field speaker. . . . 2.49
- 5" 450 ohm field speaker, with output transformer for 50L6. . . . 2.19
- 12" 1000 ohm field Operadio. . . . 4.95
- 12" 450 ohm field R.C.A. . . . 4.95

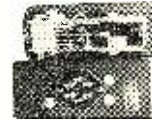

**Heavy Duty Vibrator**—Made for 6-110 volt amplifiers. Freq. 60 CPS. Scoop price, \$1.99. 135 ma 6-110 volt conventional power transformer, with all windings; will run phono motor. \$5.95 (Use with above vibrator)



**PORTABLE P.A. \$39.95**

18 watt complete portable public address system. Has inputs for a crystal or dynamic mike and phono pick-up. Has push-pull 7C5 tubes in output. Attractive leatherette covered split type case. Priced complete with two 10" PM speakers. This is a complete public address system wired ready to play. Stock No. RC-18. Net \$39.95. Priced complete with crystal mike and desk stand.

Amplifier chassis only with tubes, less speaker, case and mike; in kit form. Diagram furnished. Stock No. AC-18 Net \$10.95. AC-18 amplifier wired and tested. Net \$14.95.

**RCA LICENSED**

**COIN OPERATED RADIO SCOOP PRICE \$24.95**

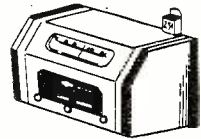

Coin Operated Radio. The Sensation of the year. 6 tube, 2 band, American and Foreign shortwave. Gray metal case, trimmed with chrome, made by America's largest manufacturers. R.C.A. licensed. Start your own money making business. Finance through your local bank and put in Hotels and Tourist Cabins, in your community. You can buy this fine radio unit for about one-half the price the largest operators in the nation have paid for them, the last two years. Has 25c slot, set to play for two hours. This radio has out-sold all other coin operated sets. Even this fine AC chassis is worth more than our price for the whole radio. It is especially made to be easy to service. Don't miss on this. You can have your own business, with 100 of these radios located near your home and they will bring you profit for years to come. Remember, they won't last long at this price. Net Price in single lots, \$24.95, 5 for \$110.00. Write for 100 lot price.

**12 IN. ALNICO V P.M. SPEAKER \$6<sup>95</sup> EACH**  
 TWO FOR \$12<sup>95</sup>

Latest 1948 Production 6.8 oz. Alnico V PM speaker with 6.5 ohm voice coil. Will take 15 watts. Beautiful grey finish, with pot cover. Worth twice our price. A nationally known make. Stock No. CH-12. Weight 6 lbs. Net, \$6.95; 2 for \$12.95.

**\$4<sup>95</sup> EACH** 3 FOR \$14<sup>00</sup>

Super value. Folded Di-pole antenna, for FM and Television. Complete with 60 feet of twin 300 ohm line and 4 low-loss stand-off insulators. This folded di-pole covers frequencies 42 through 108 megacycles. Trombone action makes exact tuning to any one weak station. Furnished with adjustable mounting bracket. Has 5 foot mast. Made for Stromberg-Carlson. Stock No. Mf-300—Net \$4.95. Weight 4 lbs. Individually packed.



**Crystal Calibrator \$2.95**  
 Crystal Calibrator, gives 50 KC beat note through an Xtal cycled, multivibrator. Furnished complete, less 200 KC Crystal. With tubes 12SA7 and 2-12SL7. A handy item to have. Scoop price . . . . . \$2.95

**ORDER 100 RADIO TUBES \$35.00**

Individually Cartoned — Full Replacement — Branded HYVAC — You Pick the Types from List Below — 39c EACH — 100 for \$35.00

- |          |          |       |
|----------|----------|-------|
| 117P7GT  | 607 GT   | 1S5   |
| 32L7GT   | 6V6 GT   | 304   |
| 12A8GT   | 6X5 GT   | 3S4   |
| 12K7 GT  | 6SA7 GT  | 1B4   |
| 2526 GT  | 6SD7 GT  | 12K8  |
| 6A7      | 6SK7 GT  | 12A6  |
| 47       | 6SN7 GT  | 12SF7 |
| 12F5 GT  | 6SQ7 GT  | 6F5   |
| 688 GT   | 25L6 GT  | 6J5   |
| 6P5 GT   | 7017 GT  | 6SJ7  |
| 3V4      | 117L7 GT | 12SJ7 |
| 6C5      | 11Z3     | 6A6   |
| 12SA7 GT | 12AT6    | 6SF5  |
| 12SK7 GT | 12BA6    | 6BA6  |
| 12SQ7 GT | 12BE6    | 6BE6  |
| 35L6 GT  | 35W4     | 6AT6  |
| 35Z5 GT  | 35B5     | 6X4   |
| 50L6 GT  | 50B5     | 6BJ6  |
| 6K7 GT   | 1T4      | 6AK5  |
| 6A8 GT   | 1L4      | 6BH6  |
| 5Y3 GT   | 1U4      | 80    |
| 6K6 GT   | 1R5      |       |

**75% OF ALL THE TUBES YOU USE 49c EACH**

**Guaranteed Standard Brands Cartoned and Uncartoned**

12AH7	6IK7	6SL7	12S67	12SR7
27	9001	6SN7	12SH7	12SR7
26	9002	6SG7	12SJ7	50L6
78	9003	6SR7	12SA7	12SK7
76	1B25	6V6 GT	12SL7	35L6 GT
354	6SA7	6X5 GT	12SC7	35L6 GT
5U4G	6SC7	6AB7	1T4	35Z5 GT
5Y3G	6SF7	12AT6	1R5	35W4
6AC7	6S07	12BA6	1S5	50B5
6C5	6H7	12BE6	6R7	
6B5	6J7	2H6	6L7	
615	6SK7	12S GT	6Z7	

59c each 1/2 Volt Octal—1N5 GT, 1H5 GT, 1A7 GT, 1A5 GT, 69c each Local Tubes—50A5, 35A5, 7A7, 7B7, 7E7, 7F7, 7N7, 7C5, 7Y4, 0Z4, 35Y4, 14A7, 14B6, 14Q7, 7E5, 79c each 1/2 Volt Local Tubes—1L5, 1L6, 1L4, 1L3.

**McGEE RADIO COMPANY** WRITE FOR CATALOG PRICES F.O.B. K. C.

SEND 25% DEPOSIT—BALANCE C.O.D. 1225 McGEE ST., KANSAS CITY, MISSOURI

# Personal

## PORTABLE RADIO KIT MAKES A \$32.50 RADIO

Complete with Batteries

# \$14.95



Size: 6 1/2" x 3 1/4" x 4 1/8"

Weights Only 3 1/2 Lbs.

- Two-Tone Ivory, Red Plastic Cab.
- Loop Aerial, Built-in Lid
- 4-Tube Superhet
- AVC.
- Looks like and is a Commercial Radio Kit
- Two-Gang Cond., Lucite Dial
- Simple Assembly and Wiring Instructions

This kit is ready for immediate delivery. The same nationally known factory that manufactures tens of thousands of this radio, is line-producing this radio kit for you. Every part, from the cabinet down to the last resistor, is matched. The chassis is ready punched; all you do, is mount the parts and wire. This radio kit will assemble into a beautiful personal radio for you, just the same as it does for the factory. We furnish you a diagram, photograph of the completed chassis and full assembly instructions so that those with a minimum knowledge of radio may wire this kit. The beautiful case is made of metal with plastic hinged lid and snap-on back. The lucite face of the receiver has an inlaid gold design. The circuit is the conventional two gang superhet type, with A.V.C. Receives the broadcast band, 540 to 1650 KC. Uses miniature tubes: 1R5 converter, 1S5 detector A.V.C., IT4 amplifier and 3S4 power amplifier. Alnico V P.M. speaker. The loop antenna is built in the lid. Radio comes on automatically when lid opens. Operates on self-contained batteries. Priced complete with tubes and 67 1/2 volt "B" battery and flash cell (Not AC-DC). Nothing else to buy. Model X-45, Price \$14.95. Include Postage for 6 lbs.

SCOOP MODEL X-45 PERSONAL PORTABLE KIT WIRED AND TESTED WITH BATTERIES. NET \$17.95

### 8-TUBE RADIO KIT WITH COAXIAL SPEAKER, \$37.95

A COMBINED BROADCAST SUPERHET RADIO CHASSIS AND 15 WATT P. A. SYSTEM  
HEAVY DUTY 12" P.M. SPEAKER  
CROW 8" SLIDE RULE DIAL. 2 GANG COND.  
REC. BROAD. 550 TO 1700 KC AND 19 TO 49 METERS  
PUSH PULL 6V-—TONE CONTROLS  
INPUTS FOR CRYSTAL OR DYN. MIKES AND PHONO-PICKUP. WE FURNISH EVERYTHING TO BUILD THIS DELUXE CHASSIS

- WHY NOT ORDER THE ARMCHAIR CABINET WITH THIS KIT
- HAS INPUT GAIN FOR THE G.E. VARIABLE RELUCTANCE PICKUP
- CHASSIS SIZE 9 1/2 x 11 x 8" HIGH

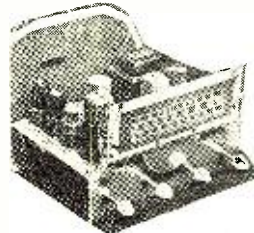

Here is something new in radio. A real 15 watt power amplifier with bass and treble controls. Has extra gain stage for crystal or dynamic mikes. And on the same chassis, a standard superhet radio receiver. We furnish all parts, knobs, escutcheon plate and tubes: 6SA7, 6SK7, 6SR7, 6SN7, 6SJ7, two 6V6 and 5Y3. No cabinet. Extra care in designing the power supply section assures low hum level, making this unit ideal for recording as well as P.A. use. We furnish everything as well as schematic diagram and photos of the completed chassis. Weight 35 lbs.

PRK-24 Radio-Amp. Kit with 12" P.M. speaker. With tubes .....Net

**\$29.95**

CPR-15. Exactly the same kit as the PRK-24 kit, except it is furnished with a 12" Chandelograph wide range speaker. (Has built-in high frequency tweeter.) This is our finest kit.....Net

**\$37.95**

### 6-110 VOLT POWER SUPPLY KIT MAKES ANY AMP. WORK ON \$14.95 A STORAGE BATTERY

New Power Supply Kit adapts any amplifier to 6-110 volt operation. Kit includes all parts, tubes, transformer, vibrator, ready-punched chassis and diagrams necessary for you to build this 6 volt DC or 110 volt AC power supply. The average radioman should wire this unit in an hour or less. Supply furnishes from 110 volts 60 cycle, 350 volts DC at 135 mills, 6.3 volts AC. Also, from 6 volts DC it produces 110 volts 60 cycle AC to run a phono motor, record changer, or small AC-DC radio; 350 volts DC at 135 Mills. Instructions are furnished, to show you how this supply can be adapted to make any P.A. system, up to 25 watts, operates on 6 volts DC or 110 volts AC. Switching is done in the power supply. Everything complete, including 2-6X5 rectifiers. Kit 6-110KR. Net \$14.95. Spare heavy duty vibrator, \$1.95 extra.



### 6-110 VOLT AMPLIFIER KIT, \$29.95

Model 22-KR—a complete kit of parts to build a 25 watt, 6 volt DC and 110 volt AC amplifier, utilizing the above power supply. Has push-pull 6L6 output tubes, with universal output transformer, 4-8-16-500 ohm line to voice coil winding, dual tone controls, inputs for crystal or dynamic mike and phono pick-up. Every part and tube, as well as diagrams and ready punched chassis furnished. You get the above 6-110 volt power supply kit and the amplifier kit pictured. Net \$29.95.

### 6-110 VOLT AMP. KIT FOR WIRE RECORDING, \$32.95

This amplifier kit is similar to kit 22-KR, except has oscillator and switching feature for wire recording and play back. Output 20 watts. Kit 34-KR Net \$32.95. WEBSTER WIRE RECORDING MECHANISM, \$44.10

### 4 TUBE RADIO KIT \$6.95

4 tube AC-DC, TRF radio kit. Ideal for students and beginners. Every part furnished to build this kit, including tubes, diagram and photos. Has Alnico V P.M. speaker and tubes 12SK7, 12S17, 501B5 and 35W4. Plastic cabinet with slide rule dial. Receives broadcast 550 to 1600 KC. This is the easiest type of radio to build. Kit Model TP-4 Net \$6.95. Weight 6 lbs.

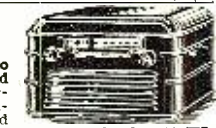

### INTER COM KITS \$7.95

Inter-com kit. All parts furnished to build a small two-way call system (Master and one sub-station speaker). Has 3" speaker and tubes 70L7 and 12SL7. Has separate 3" speaker for sub-station. Ready punched chassis. Everything complete, less cabinet. Diagrams and photo furnished. Kit TB-3. Net Price \$7.95.

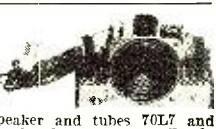

### BUILD A RADIO Like you would buy 5-TUBE KIT ONLY \$9.95

Made from Detrola Components  
Attractive 13" blond cabinet AC-DC radio kit, with illuminated slide rule dial. Incorporates a standard 2 gang superhet circuit. Loop antenna, ready-punched chassis. This is another one of our line production radio kits. Every part is furnished. Includes tubes: 12SA7, 12SK7, 14A7, 35Z3 and 50L6. Diagram, photos and instructions are included. Has full 5" Alnico 5 P.M. speaker. Receives broadcast 550 to 1650 KC. Shipping weight 9 lbs. Model TF-6. Net \$9.95.  
Model TF-6 wired and tested.....\$14.95



### 1949 MODEL AC-DC KIT \$12.95

This is our latest and finest AC-DC radio kit. Receives Broadcast, 540 to 1650 KC. Has full length illuminated slide rule dial. Choice of Ivory or Walnut plastic cabinet. Full high efficiency 2 gang superhet circuit, with loop antenna. Ready punched chassis, full 5" P.M. speaker. Every part fits. Everything furnished, including tubes, 12SA7, 12SK7, 12SQ7, 35Z3 and 50L6. This kit will go together just like it would on the production line. Diagram, photos and instructions are furnished. Shipping weight 9 lbs. Kit Model XA-49. Net \$12.95.



### AMERICAN AND FOREIGN KIT \$14.95

550 to 1600 KC and 6 to 18 MC  
This radio kit is housed in an attractive grey onalcent finished metal cabinet. Incorporates a standard 2 gang superhet circuit. Receives Broadcast (550 to 1600 KC) and foreign short wave (6 to 18 Megacycles). This kit is complete, nothing else to buy; just as all our kits. Ready-punched chassis. It will go together just as it would down a production line. Has full 5" P.M. speaker. Complete with tubes: 12SA7, 12SK7, 12SQ7, 35Z3, 50L6. Diagram, photos and instructions are furnished. Shipping weight 10 lbs. Kit model DT-5. Net \$14.95.



### 12 WATT AMPLIFIER KIT, \$10.95

Push Pull 6V6's Gain for Mike  
KIT MODEL AC-12. 12 watt amplifier kit. Ideal for high quality record player as well as public address or recording amplifier. Matched component parts, ready punched chassis pan. One control fades from phono to microphone. Gain enough for crystal or dynamic microphone. 100 mil power transformer, for 110 volt AC 60 cycle operation. Priced complete with tubes: 2-6V6, 6SN7, 6SR7 and rectifier. Diagrams and photos furnished. Kit AC-12. Net \$10.95. 12" Alnico 5 P.M. speaker \$6.95 extra; crystal microphone and desk stand \$4.95 extra.  
The above AC-12 amplifier wired and tested ready to operate net \$14.95. Specify Stock No. AC-1125. 12-inch Alnico V P.M. speaker \$5.95 extra. Crystall mike and desk stand \$4.95.



### 20-WATT UTILITY AMP. KIT, \$17.95

Build this 20 watt utility 110 volt AC, 20 Watt power amplifier. Ready punched chassis, size 12 x 6 x 2 1/2 inches. Has two input circuits, one mike and one phono. Mike stage has 135 DB gain, for crystal or dynamic mike. Has bass and treble controls. Designed for use with P.M. speakers; has 8-16 ohm output transformer. All parts and easy-to-follow diagram furnished, including tubes: 2-6SN7, 6L5, 2-6L6GA, 5Z3. Kit Model 20-LX.....Net \$17.95



### POWERFUL SINGLE RECORD PLAYER Z-26

110 used in an attractive leatherette covered cabinet. Latest 78 RPM rim drive motor and light weight pick-up. Ready wired and tested 70L7 type tube amplifier. Tone and volume control, 5" FM speaker (Alnico V). This kit easily slides together. Priced complete with tubes and hook-up instructions. Kit Z-26.....Net \$9.95



### ARMCHAIR CABINET \$29.95 Will House PRK-24 or CPR-15

Beautifully made walnut armchair cabinet. Outside dimensions 24" high, 16 1/2" deep, and 27" wide. Ample room for radio receiver 14" long, 9" high and 10" deep. Will hold a changer up to 14" square. Will accommodate speaker up to 12". Has record album storage compartment. Hinged lid covers changer compartment. Cabinet Ar-15 Net \$29.95. Detrola automatic changer \$12.95 extra.

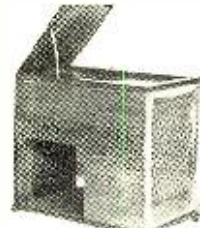

### ARMCHAIR CABINET IN BLOND FINISH, NET \$34.95

### 3-WAY PORTABLE KIT \$16.95

- 4 Tubes Plus Disc Rectifier
- 300 Hour Battery Pack Included
- Beautifully Built Portable Case

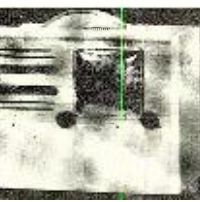

Build this powerful, 4-tube, 3-way portable kit. Operates on 110 volts AC or DC or self-contained batteries. Receives broadcast 550 to 1650 K.C. Incorporates a standard superhet circuit with AVC and loop Ant. Has Alnico 5 P.M. Speaker, 2 gang condenser. All parts and batteries are furnished including tubes. Disc Rectifier, 11S, IT4, 1S5 and 3S4. Has attractive leatherette portable cabinet size 7x9x9. Weight 14 lbs. Kit Model 3-ZA.....Net \$16.95

### SMALL PORTABLE KIT, \$10.95

- 4-Tube Broadcast Superhet
- Priced Complete with Batteries
- Dynamic Speaker

PORTABLE KIT MODEL K-PX. Small size leatherette covered case 9x5 1/2x5. Easy to build. Operates on self contained B and A batteries. Rec. Broadcast 550 to 1600 K.C. Incorporates a standard superhet circuit with avc. Has 3 inch Alnico five P.M. speaker. Priced complete with batteries, pictorial diagram and tubes 1R5, 1S5, IT4 and 3S4. Not AC-DC, but straight battery operated. Has 2 gang cond. Everyone should have one of these personal portables. Everything furnished. Kit K-PX.....Net \$10.95



### CARBON HAND MIKE, 99c

Army carbon hand mike with push-to-talk switch, cord and plug. Brand new and factory cartoned. While they last, 99c each; two for \$1.89; ten for \$6.90.



# What's New in Radio

## POWER CONVERSION UNIT

Of interest to the radio amateur is the new line of power conversion units being announced by *Radio Products Sales, Inc.* of Los Angeles.

Designed to permit operation of d.c.-operated war surplus equipment on a.c. lines, these units feature ease of installation and the elimination of

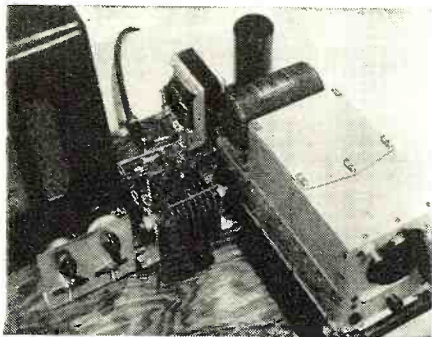

complicated and unnecessary rewiring.

A basic schematic is furnished with each power conversion unit. The units are available with transformers to match in nine popular models with d.c. outputs ranging from 14 volts at 2, 4.5, 10, and 40 amperes to 28 volt units at 1.8, 5, 10, 20, and 40 amperes.

Special units are also available for operating equipment not covered by the standard models.

*Radio Products Sales, Inc.*, 1501 South Hill Street, Los Angeles 15, California will supply full information to those requesting it.

## MOUNTING BRACKET

Of particular interest to servicemen is the new adjustable speaker mounting bracket being offered by *Wright, Inc.* of St. Paul, Minnesota.

This new bracket is now being included as standard equipment on the company's line of replacement speakers. Thus equipped, 4½, 5, and 6 inch speakers may be used as replacements in practically any table model radio.

*Wright, Inc.*, 2233 University Avenue, St. Paul 4, Minnesota will supply full details on their new speaker line which includes the ingenious adjustable mounting bracket feature.

## "QUIK-RIG" ANTENNAS

Production on the company's line of "Quik-Rig" television antennas has started at the *J.F.D. Manufacturing Co., Inc.*, plant at Brooklyn, New York.

According to the company, the new antenna can be assembled in less than 30 seconds. In the disassembled state, the antenna forms one complete, compact unit free from all loose elements and hardware. The dipoles and reflectors, which are folded up against the

side of the crossarm, are simply swung out into position and tightened by means of attached wing nuts.

A specially engineered mast arrangement permits rapid on-the-job enlarging and stacking of arrays to suit local conditions. A heavy-duty U-bolt clamp permits the unit to be attached to any size mast up to 1½ inch o.d. This clamp also provides ¼, ½, or ¾ wavelength spacing of any number of bays on the array and allows each bay to be independently oriented.

A bulletin describing the new "Quik-Rig" line is available from *J.F.D. Manufacturing Co., Inc.*, 4117 Fort Hamilton Parkway, Brooklyn 19, New York.

## HIGH VOLTAGE METER

*Spellman Television Co., Inc.*, has announced production on a new high voltage meter which has been especially designed for projection television servicing and installation.

The meter covers the range from 0 to 30 kilovolts. It incorporates a 4 inch scale and draws only 20 microamperes. The bakelite meter panel is housed in a solid oak cabinet with a sloping panel for easy reading.

Full technical details on this unit are available from *Spellman Television Co., Inc.*, 130 West 24th Street, New York 11, New York.

## TUBE CHECKER

*General Electric Company's Specialty Division* has announced a new tube checker, the Type YTW-1.

Operating flexibility has been attained in this checker with each tube element having its own individual circuit switch. The unit tests 4, 5, 6, 7, and 8 pin standard, 5 pin small, 7 and 9 pin miniature, and lock-in tubes, as well as pilot bulbs and batteries.

The checker tests for filament con-

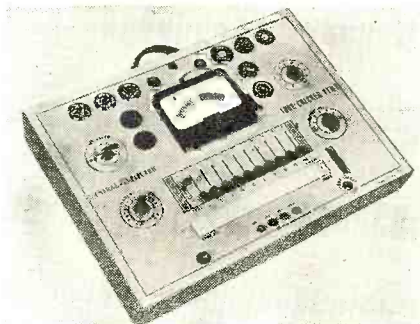

tinuity, heater cathode, open elements, shorted elements, and quality of emission.

The device is completely portable, weighing only 15 pounds, and operates from standard a.c. power source.

Further information on the new Type YTW-1 may be secured from the *Specialty Division, General Electric Company*, Electronics Park, Syracuse, New York.

## NEW MAGNETAPE RECORDER

The latest addition to the "Magnetape" recorder line, the Model SP850, has been unveiled by the *Magnephone Division of Amplifier Corp. of America*.

Designed for broadcast, recording studio, and all semi-professional applications, the new model is ruggedly constructed and self-contained. The unit consists of an efficient tape pulling mechanism, a recording amplifier with supersonic bias and erase oscillator, a playback amplifier, monitor amplifier and speaker, all housed in an enclosed relay rack cabinet measuring 20½ inches high by 15 inches deep by 21 inches wide.

A vacuum tube type VU meter is

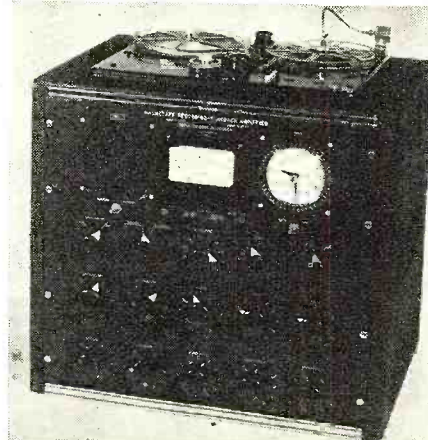

built-in and includes an adjustable sensitivity range of 18 db. for indication of proper recording level on all types of magnetic tape.

For additional information on this recorder, including a complete set of technical specifications, write for catalogue No. 4904, *Magnephone Division, Amplifier Corp. of America*, 398-2 Broadway, New York 13, New York.

## REPLACEMENT MIKE

*Electro-Voice, Inc.* is introducing the new Series 210 high articulation carbon "Mobil-Mikes" to be used as exact replacement units in current *Motrola, RCA, General Electric*, etc. mobile equipment for commercial and emergency two-way communications.

A metal button at the rear of the microphone case fits the filament control switch bracket. The microphones are rugged, housed in a high impact phenolic case with a 5/32 inch wall. The units weigh only 7 ounces and fit comfortably in the hand. The micro-

# Jensen Custommode

# presents four basic units

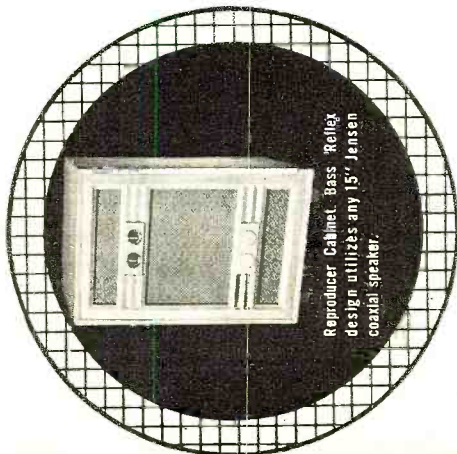

Reproducer Cabinet. Bass "Relief" design utilizes any 15" Jensen coaxial speaker.

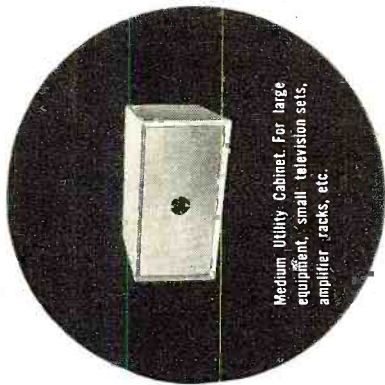

Medium Utility Cabinet. For large equipment, small television sets, amplifier racks, etc.

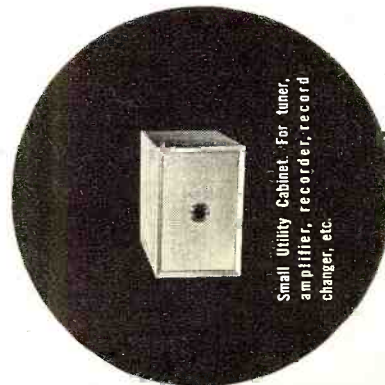

Small Utility Cabinet. For tuner, amplifier, recorder, record changer, etc.

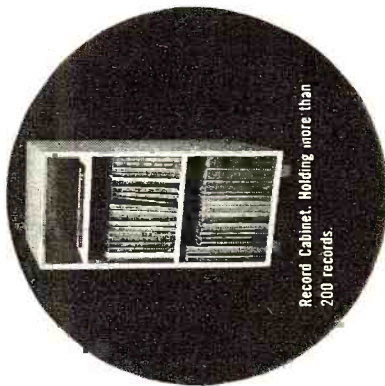

Record Cabinet. Holding more than 200 records.

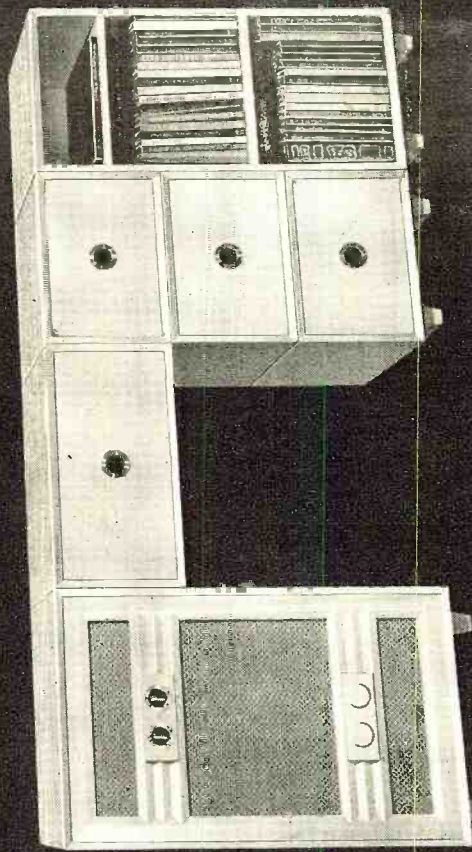

**Assemble your own Entertainment Center with distinctive functional decorator-designed Custommode**

Jensen Custommode was created to solve the custom-builder's problem—how to integrate fine sound reproducers and associated audio-video equipment into the space and decorative scheme of the home. Custommode's universal "building block" flexibility permits stacking in literally hundreds of different combinations insuring maximum utility for all layout arrangements. In blond or Cordovan mahogany.

*Write today for full information and scale cut-up illustrations*

**Jensen** MANUFACTURING COMPANY  
6601 S. Laramie Ave. Chicago 38, Illinois

# SAVE \$ 0 RADIO SURPLUS

## U. S. SIGNAL CORPS 5 METER SHORT WAVE XMTRS.

(72.2Mc) XMTRS and TUBE only, less mike, batteries and antenna. One 1½ volt dry cell and 67½ volts of B operates it. Just attach di-pole, key or mike, connect the batteries and it's ready to use. Signal Corps spec wired with silvered wire, mica condensers, and precision resistors. Highly stable circuit with Lo-Loss silvered inductance. (Adjustable paddler) Schematic supplied. Converts easily to walkie-talkie and Ham bands. **\$3.25**



**GENUINE SIGNAL CORPS FEATHER-WEIGHT HEADPHONES WITH CORD AND PLUG 2000 OHMS—8000 OHMS IMPEDANCE** **\$1.00**

## NATIONALLY KNOWN OIL FILLED FILTER CONDENSERS

1.—MFD—2000 volts..... **95c ea.**  
1.—MFD—1000 working volts. 4 for..... **\$1.00**

## FAMOUS BRAND RECORD CUTTING HEAD

These units are all Brand new and were made for a nationally advertised manufacturer to be in their quality Home Recording Radios. Size 1½x2¾ ready to fit your cutting arm or bracket. SPECIAL. **\$2.95**

**3 BAND ALL-WAVE DIAL 6" DIAMETER**..... **75c**

**AMPLIFIER CHASSIS, SIZE 18"x8"x2¼"** BLUE CRACKLE FINISH DRILLED FOR CONDENSERS—TRANSFORMERS AND SOCKETS..... **55c**

**U.S. AIR FORCE RESISTOR ASST. ¼-½-1 WATT—100 PIECES**..... **95c**

**U.S. AIR FORCE MICA COND. ASST. 25 PCS. 50M-1000MFD**..... **49c**

Low-Loss-Short Wave Variable Condensers ¼" Shaft Type	3 GANG T.R.F. VARIABLE CONDENSERS .000365 Cap..... <b>95c</b>
5 Plate—20 MMFD..... <b>20c</b>	D.P.D.T. SLIDE T O G G L E SWITCH..... <b>23c</b>
9 Plate—30 MMFD..... <b>25c</b>	2 piece 5-pole..... <b>15c</b>
14 Plate—50 MMFD..... <b>27c</b>	Male and Female Separable plug, Male is for panel mount. Female for Flex. cord. A steel. at only..... <b>35c per pr.</b>
27 Plate—100-110 MMFD..... <b>45c</b>	
37 Plate—150 MMFD..... <b>50c</b>	
38 Plate—150-155 MMFD..... <b>55c</b>	
53 Plate—210-21 MMFD..... <b>60c</b>	
Lock Type Air Trimmer Variable Condensers	
3 Plate—12-15 MMFD..... <b>10c</b>	
5 Plate—20 MMFD..... <b>11c</b>	
8 Plate—30-35 MMFD..... <b>13c</b>	
10 Plate—40 MMFD..... <b>14c</b>	
13 Plate—50 MMFD..... <b>17c</b>	
14 Plate—56 MMFD..... <b>20c</b>	
20 Plate—80-100 MMFD..... <b>25c</b>	
27 Plate—100-110 MMFD..... <b>35c</b>	

**SIGNAL CORPS TRANS. KEYS**..... **39c**  
**4 PRONG WAFER SOCKETS—\$1.49 per C.**..... **3c each**

**ISOLANTIN OCTAL WAFER SOCKETS—\$4.25 per C.**..... **6c each**

**PHILO 4 MF—300 V—1% CAN CONDENSER—\$8.00 per C.**..... **10c each**

**W-L—10 W. 1,000 ohm POWER RHEOSTAT**..... **29c ea.**

**5-6 PRONG WAFER SOCKETS..... \$2.50 per C**

**100 ASST. SOCKETS—4-5-6-7—OCTAL**..... **\$3.50 per C**

**1,000 OHM WIRE WOUND POTENT..... 15c**

**30 HY-FILTER CHOKE SHIELDED..... 49c**

**UNSHIELDED..... 39c**

**100 ALLEN BRADLEY—I WATT—½ MEG RESIS..... \$1.25**

**100 ERIE—I WATT—2,000 OHM RESIS..... \$1.15**

**10 WIRE WOUND RES. KIT—3-5-50 W. ASST. 49c**

**2 METER RF CHOKES..... \$1.00 per doz.**

**PHONO PICK-UP REST. RUBBER—I HOLE MTG..... 7c**

**2,000 OHM WIRE WOUND RHEOSTATS..... \$1 per doz.**

**RCA-VICTOR NEEDLE CUPS—2 PIECE..... 10c ea.**

**CARTER WIRE WOUND C.T. VARIABLE 20 OHM RESISTORS..... \$1.00 per doz.**

**G. E. TAPPED VOLTAGE DIVIDER—200 WATT—230 OHM—MOUNTED ON ASBESTOS BASE—TAPPED AT 180-205 ohms..... 25c**

**RCA 6 OHM POWER RHEOSTATS..... 39c**

**RCA RUNNING BOARD AUTO AERIAL..... 49c**

**PHILO AUTO SUPPRESSORS..... \$5.00 per C.**..... **7c ea.**

**MINIMUM ORDER \$2.00—NO C.O.D. SHIPMENTS—PLEASE INCLUDE POSTAGE**

**NEWARK SURPLUS MATERIALS CO. 324 Plane Street Dept. SE Newark 1, N. J.**

**Signal Corps Flex, hook-up wire asst. contains approx. 150 ft. asst. colors, glass insulation. 1 lb..... \$2.50**

**GENERAL ELECTRIC 60 CYCLE WATT HOUR METERS, slightly used, perfect condition, same as used in your home. 110-125 volts. 5 Ampere..... \$3.50 120 Amps..... \$4.50**

**PHILO MAGNETIC RELAY TAP SWITCH. Operates on 6 V DC—15 V AC. When contact is made relay operates rotary contacts switch to 20 different contacts. Brand new..... 89c**

**I. C. A. 30 MH RF choke..... 25c**  
**Grind your own crystals—Pure Brazilian Quartz all sizes and thicknesses—½ lb. package..... \$1.00**

**National Vernier Vernier Dial Attachment—¼" shaft—converts any dial to slow motion vernier..... 75c**  
**340 degree dial with 10 push button attachment—¼" shaft—ideal for Xmitters—Sig Gen. or Osc..... 49c**

**RCA Band Switches—3 gang 3 posit. 3 band..... 30c HIGH FREQUENCY 5 gang 5 posit. 4-5 band..... 40c BUZZER..... 39c**

**Trimmer-Padder Asst.—all isolantite—singles, dual, triples—100 asst. Pieces..... \$2.25**  
**Signal Corps V. T. 1 receiving tubes—per doz..... \$1.00**

**MAGNAVOX—12"—900-1100 ohm Dynamic speakers..... \$3.95 8"—10,000 ohm Dynamic speakers..... \$1.35 3"—450 ohm AC-DC dynamic..... \$1.49 8"—2 M..... \$1.49 5" 5M OHM RCA SPEAKER..... \$1.00**

**Spaghetti Assortment—Approx. 75 ft..... 75c**  
**30-WATT-6L6 BEAM POWER AMPLIFIER KIT. Complete kit of parts with all necessary parts—Tubes—ready to assemble and wire. Plate supply—is provided by an oversize extra heavy transformer—(3) Filament supplied by an extra heavy transformer filter, bypass and filter condensers. Sockets all ready mounted on chassis. Volume and tone controls with separate AC switch are provided. Circuit is the latest type of phase inverter system using 1-5Z3, 2-6L6, 1-6CS, 1-6S17, 1-6W7. Chassis has ample room to work on or add 1-6W7. Terminal strips for mounting resistors, etc., more tubes—terminal strips for mounting resistors, etc., are also provided, and all parts are Signal Corps spec. Brand new, never used before. A large diagram is provided so that a novice may be able to assemble this kit with ease, merely by following the point to point connections that are outlined on the print. Complete connections that are outlined on the print. Complete connections that are outlined on the print..... \$17.95**

**DRY ELEC. FILTER COND. ASST. CONTAINS 10 PIECES ALL BRAND NEW 50-450V..... \$1.10 6 ASST. WET ELECTROLYTIC CONDENSERS..... 59c**

**RADIO EXPERIMENTER'S SURPRISE PACKAGE—CONTAINS BYPASS & FILTER CONDENSERS, SHORT WAVE TUNING UNITS, POWER AND AUDIO TRANSFORMERS, SOCKETS, RESISTORS, CHASSIS HARDWARE, OVER 20 LBS. OF VALUABLE PARTS..... \$4.95**

**HEAVY DUTY SHIELDED GENERATOR CABLE. 3½" Long. WILL CARRY 35 AMPS—3 WIRE..... 19c**  
**DRILLED CHASSIS FOR 5-6 tubes 7"x10"x1½" BOX. 15½"x10¼"x8" WILL FIT 8" MOTOROLA AUTO RADIO VIBRATOR TRANSFORMER..... 25c**

**RCA ADJUSTABLE CODE INTERFERENCE WAVE TRAP 456-475 K.C..... 39c**  
**MOTOROLA AUTO RADIO VIBRATOR TRANSFORMER..... 75c**

**PHONE JACKS—OPEN & CLOSED AUTOMATIC..... 18c**  
**RCA DOUBLE FILTER CHOKE..... 89c**  
**ZENITH RADIO CABINET & SPEAKER BAFFLE BOX. 15½"x10¼"x8" WILL FIT 8" SPEAKER—MAHOGANY FINISH—BRAND NEW..... 95c**

**NATIONAL 8-8-450 VOLT CAN FILTER CONDENSER..... 39c**  
**EBY SPEAKER VOLUME CONTROL WIRE WOUND 15 OHMS FOR USE IN CONTROLLING VOLUME ON P. A. SPEAKERS WITH SWITCH..... 2c ea.**

**SPECIAL 25c ea. LOTS OF 50..... 2c ea.**  
**SALE—PHONO RECORD ALBUMS—SALE..... 49c 10"—3 comp.—15c; 4 comp.—20c; 12 comp. 69c 12"—3 comp.—15c; 4 comp.—20c; 12 comp. 69c**

**RECORD PLAYER CABINET & BASE—38" Hx 14" Wx10¼" D—MAHOGANY MADE FOR MOTOROLA AUTO RADIO VIBRATOR—8" SPEAKER & AMPLIFIER..... \$2.95 ea.**  
**LIMITED QUANTITY ONLY..... \$2.95 ea.**

**KOLSON 7½" watt amplifier with 12" speaker—\$9.175.00; less tubes, cut to \$9.95—weight 80 lbs.**  
**SERVICEMAN'S RADIO TUBE CARRIER—MADE OF BLACK FIBRE. SIZE 10"x5"x8" WITH LEATHER SHOULDER STRAP. LIMITED QUANTITY..... 49c**

phones may be used indoors or outdoors in any kind of weather.

For complete information and data write for "Mobil-Mike" Bulletin No. 140, to *Electro-Voice, Inc.*, Buchanan, Michigan.

## AUDIO OSCILLATOR

*General Electric Company's* Electronics Department is announcing the new Type YGA-4 audio oscillator which has been designed especially for the radio serviceman.

The new device designed for use in testing radio receiver audio channels, p.a. systems, intercoms, and other audio work, features a low distortion

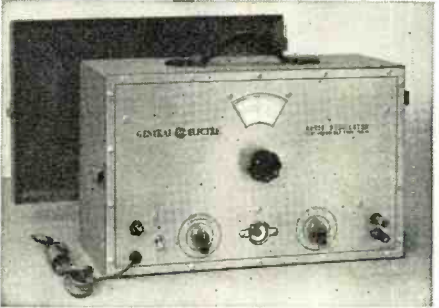

output in one band over the audio spectrum from 25 to 16,000 cycles.

A large illuminated dial facilitates the rapid check of audio circuits and equipment for frequency response, distortion, gain, power output, and phase shift. A stable b.f.o. circuit enables the YGA-4 to deliver a low distortion output voltage which remains constant within plus or minus one decibel over the frequency range 50 to 15,000 cycles.

The instrument weighs 21 pounds and operates on standard power of 50-60 cycles, 105-125 volts.

Further information on the new audio oscillator, Type YGA-4, can be obtained from the *General Electric Company, Specialty Division*, Electronics Park, Syracuse, New York.

## INEXPENSIVE INTERCOM

*Brooks Radio Distributing Corp.* of New York is currently merchandising the new low-cost "ElectroVox" intercom which is designed for home, school, office, etc., installation.

This "Electronic Interphone" operates on either a.c. or d.c. and uses three easily-replacable standard radio tubes. The master unit is 10 inches high and weighs less than 3 pounds. The remote unit is 5 inches square.

A data sheet which includes prices and further details may be secured on request from *Brooks Radio Distributing Corp.*, 80 Vesey Street, New York 7, New York.

## INDOOR TV ANTENNA

*The Workshop Associates* of Newton Highlands, Massachusetts, has a new all-channel television and FM antenna which has been designed for indoor installation.

The "Bi-Conical" unit is constructed (Continued on page 108)

## LEARN CODE FASTER with Ingenious Code Tutor

### The Precision Transmitting Machine

Now! Learn by ear automatically. Listen to code characters sounded precisely at any speed you desire—on the clear Tone-Buzzer of the CODE TUTOR mechanical transmitter. Then, repeat back and duplicate each character's sound on Practice Key. In no time, develop transmitting perfection that will amaze you.

### EXCELLENT FOR CLASS WORK

Get your CODE TUTOR today from your dealer or factory direct. SPECIAL low introductory price—only \$7.95, complete. Two sets, for communication practice, only \$14.95, post-paid. Also Free details on many interesting uses for CODE TUTOR. Write NOW!

**INTERNATIONAL ELECTRIC CO.**  
1836 W. North Ave., Chicago 22, Ill.



## TIMERS \$2.95!!

Cramer timer with Veeder counter in hours and 1/10 hours to 9999.9. 110v. 60 cycle, a.c.

## DM 35 only \$2.95

NEW BOXED. This is dynamotor for BC 61, 684, etc. 12v Input 625v @ 225 mls output.

## BC 312 RECEIVERS

Special \$54.50

## GN 45 Replaces PE 103

Externally driven generator, output 6v @ 3A and 500v @ 140 mls for BC 654 and others, \$6.45. Many other items. 25% cash with order. Balance C.O.D.

## EMMONS RADIO SUPPLY

405 - 10th STREET OAKLAND, CALIF.  
Phone TWIneaks 3-9103

**FOR THE  
NEWEST IN  
TV AERIALS**

**Watch  
WARD**

**GREATER TV  
EFFICIENCY WITH  
NEW "HIGH-LOW"  
ARRAY BY WARD**

All major parts pre-assembled.  
Saves costly installation time.

Here's another "first" by Ward in the rapidly expanding field of television reception. Advanced Ward design and engineering makes receivers work to their highest degree of efficiency.

That's the opinion of satisfied set owners, service installers, and major set manufacturers, who are all directly interested in the improved performance of television.

As a result of months of exhaustive scientific research and field testing, Ward now makes available a high band TV array which can be stacked above the standard television elements, and independently oriented! Also new is a kit for stacking two of Wards finest television assemblies into a two-bay array for a greater gain than ever before.

Sure, there have been other multiple antennas, but none with the scientifically measured spacing and complete adaptability of the new Ward models. You can see the difference yourself on the television screen when a "Magic Wand" aerial is connected to the set.

Send in coupon today for free copy of new Ward catalog.

**ORIENTING AND GAIN.** Each bay tilts in any plane, can be oriented in any direction to give sharpest focus possible. Eliminates awkward or tricky installations. Permits hairline adjustments for utmost gain on both the high and low band stations.

**ADAPTABILITY.** Ease of combination of assemblies in basic kits makes "Magic Wand" Aerials more adaptable than ever to the varying requirements of each installation. This superior flexibility means a highly specialized Ward TV aerial for each purpose, with fewer models in stock, no obsolescence, and greater profits! Write today for free catalog!

Please send me free copy of your new catalog showing latest developments in television aerials.  
NAME \_\_\_\_\_  
ADDRESS \_\_\_\_\_  
STATE \_\_\_\_\_ CITY \_\_\_\_\_  
IF JOBBER OR DEALER  
COMPANY NAME \_\_\_\_\_

**THE WARD PRODUCTS CORPORATION  
DIVISION OF THE GABRIEL COMPANY**

1524 E. 45th STREET, CLEVELAND 3, OHIO  
IN CANADA: ATLAS RADIO CORP. LTD., TORONTO, CANADA

**WORLD'S LARGEST PRODUCER OF AERIALS FOR CAR AND HOME**

**WARD  
Magic Wand<sup>\*</sup>  
AERIALS**





# 1000 KC CRYSTAL

Standard Type Holder  
BRAND NEW

# 439

# RHS

SPECIALS OF THE MONTH

## COAX FITTINGS

83-1SP-Cable Plug 39c 83-1I-Junction... 69c  
83-1R-Chassis Mt. 35c 83-168-Adapter... 29c  
83-1AP-Angle Plug 39c 83-1T-T Connector 1.39  
10H/528 .39c 10H/528 .39c

## 1 K.W. POWER SUPPLY KIT

2500—O—2500v @ 500 MA  
or  
2000—O—2000v @ 500 MA  
(Oil filled Xformer from BC 610)  
1 Smoothing Choke  
1 Smoothing Choke  
1 Filament Xformer  
2—2 Mfd.—3000v Condenser  
2—872 A Tubes  
2—Plate Caps for 872A  
2—Sockets for 872A

All Parts Now Reduced to **\$79.50**

## STEP DOWN TRANSFORMER

PRIMARY 440/220 VOLTS  
SECONDARY 230/115 VOLTS.  
.600 KVA

**\$14.95**  
Special at

## SELENIUM RECTIFIERS

Full Wave Bridge Type

INPUT		OUTPUT		
up to 18v AC	up to 12v DC	1/2 Amp.	\$ 0.98	
up to 18v AC	up to 12v DC	1 Amp.	1.95	
up to 18v AC	up to 12v DC	3 Amp.	3.45	
up to 18v AC	up to 12v DC	5 Amp.	4.45	
up to 18v AC	up to 12v DC	10 Amp.	7.45	
up to 18v AC	up to 12v DC	15 Amp.	9.95	
up to 36v AC	up to 28v DC	1 Amp.	3.45	
up to 36v AC	up to 28v DC	5 Amp.	7.45	
up to 36v AC	up to 28v DC	10 Amp.	12.45	
up to 36v AC	up to 28v DC	15 Amp.	18.95	
up to 115v AC	up to 100v DC	.25 Amp.	2.95	
up to 115v AC	up to 100v DC	6 Amp.	6.95	
up to 115v AC	up to 100v DC	5 Amp.	19.95	
up to 115v AC	up to 100v DC	3 Amp.	12.95	

## OIL CONDENSERS NATIONALLY ADVERTISED BRANDS

All Ratings, D. C.

2x.1mfd. 600v	\$0.35	1mfd. 2000v	\$0.95
.25mfd. 600v	.35	3mfd. 2000v	2.75
.5mfd. 600v	.35	4mfd. 2000v	3.75
1mfd. 600v	.35	15mfd. 2000v	4.95
2mfd. 600v	.35	2mfd. 2500v	2.49
4mfd. 600v	.60	1mfd. 2500v	1.25
8mfd. 600v	1.10	25mfd. 2500v	1.45
10mfd. 600v	1.15	.5mfd. 2500v	1.75
3x.1mfd. 1000v	.45	.05mfd. 3000v	1.95
.25mfd. 1000v	.45	1mfd. 3000v	2.25
1mfd. 1000v	.60	.25mfd. 3000v	2.65
2mfd. 1000v	.70	.5mfd. 3000v	2.85
4mfd. 1000v	.90	1mfd. 3000v	3.50
8mfd. 1000v	1.95	2mfd. 3000v	3.45
10mfd. 1000v	2.10	12mfd. 3000v	6.95
15mfd. 1000v	2.25	2mfd. 4000v	5.95
20mfd. 1000v	2.95	1mfd. 5000v	4.95
24mfd. 1500v	6.95	1mfd. 7000v	2.95
1mfd. 1750v	.89	3mfd. 4000v	6.95
1mfd. 2000v	.95	2x.1mfd. 7000v	3.25
.25mfd. 2000v	1.05	.02mfd. 12000v	9.95
.5mfd. 2000v	1.15	.02mfd. 20000v	11.95

## HIGH CAPACITY CONDENSERS

10,000 mfd.—25 WVDC	\$6.95
2x3500 mfd.—25 WVDC	3.45
2500 mfd.—3 VDC	.39
2x1250 mfd.—10 VDC	1.25
1000 mfd.—15 WVDC	.99
300 mfd.—35 VDC	.59
100 mfd.—50 WVDC	.49
4x10 mfd.—400 VDC	.89
4000 mfd.—18 WVDC	1.95
4000 mfd.—25 WVDC	2.95
4000 mfd.—30 WVDC	3.25

ALL PRICES SUBJECT TO CHANGE WITHOUT NOTICE

All merchandise guaranteed. Mail orders promptly filled.  
All prices F.O.B. New York City. Send money order or check.  
Shipping charges sent C.O.D. Minimum order \$5.00  
20% Deposit required with all orders

## XMITTER-BC-950A-121

Frequency Range — 100-156 mc.  
Four band — auto tune — crystal controlled, complete with 2-1625, 2-832, 1-815 and 4 crystals. Ant. Rectifier relay switching. Brand New..... **\$79.50**

## MOBILE or BOAT

### 12 volt INVERTER

ATR-Model RSA

Input 12v DC—Output 110v 60 cyc. 125 W. Int.—100 W. Cont. **\$16.95**  
Brand New. Special.....

## 115v DC INVERTER

Input 115v DC—Output 115v 60 cyc. 250 W. continuous. Slightly shelf-worn—but GOOD!..... **\$19.95**

## TEST PROBE

### WITH SHIELDED CABLE

For high-frequency work and to eliminate stray pickup. For use with oscilloscopes. Amphenol #93M coax. connector on one end. Part of Dumont 224A oscillograph. Special. **\$2.49**

## RADIO ALTIMETER

Xmitter-Receiver RT7/APN; complete with 14 tubes—418 to 456 mc.—28v dynamotor. Certified by CAA.

USED..... **\$12.95**  
NEW..... **\$2.50**

## SURPLUS RADIO

### CONVERSION MANUAL

115 pages of circuits and data on BC221, 342, 312, 348, 412, 645, 946, 1068, SCR274, 522, TR7, PE103, Surplus index and VT charts..... **\$2.50**

## PERMALLOY SHIELDS

### for CATHODE RAY TUBES

3" Shield..... **\$1.49**  
5" Shield..... **1.98**  
12" Shield..... **5.98**

## SCR-518 ALTIMETER

Famous SCR 518A Altimeter. Brand new factory cartoned. Worth over \$900.00 Made by RCA. Has 29 tubes. Works in the 500 MC region. This is the complete unit. Transmitter, receiver, power supply and 3' scope indicator. Reads altitude up to 30,000 ft. Operates on 28 volts. D.C. Complete with tubes. 6SK7, 2 8012, 2 6SJ7, 6C8, 6SN7, 6F8, 23D4, 6Y6, 6V6, 10 6AC7, 3 2X2, 954, 955, 956, 6J5, and 3 in. CR tube 1808P. A RED hot scoop at only..... **\$69.50**

## TRANSFORMER — 115 V 60 Cyc.

### HI-VOLTAGE INSULATION

3710v @ 10 ma.; 2x2 1/2v @ 3A.....	\$9.95
2500v @ 15 ma.....	6.50
2500v @ 4 ma.; 2 1/2v @ 2A. 6.3v @ 1 amp.....	7.95
2150v @ 15 ma.....	5.50
1750v @ 4 ma.; 6.3v @ 3A.....	6.50
1600v @ 4 ma.; 700v CT @ 150 ma.; 6.3v @ 9A.....	7.95
525-0-525v @ 60 ma.; 925v @ 10 ma.; 2x5v @ 3A; 6.3v @ 3.6A; 6.3v @ 2A; 6.3v @ 1A.....	7.95
500-0-500v @ 25 ma.; 262-0-262v @ 55 ma.; 6.3v @ 1A; 2x5v @ 2A.....	4.49
500-0-500v @ 100 ma.; 5v CT @ 3A.....	4.95
410-0410v @ 1060 ma.; Primary 110/220v.....	11.95
400-315-0-100-315v @ 200 ma.; 2.5v @ 2A; 5v @ 3A; 6.3v @ 9A; 6.3v @ 9A.....	6.50
400-0-400v @ 200 ma.; 5v @ 3A.....	4.95
350-0-350v @ 150 ma.; 5v @ 3A; 6.3v @ 6A; 78v @ 1A.....	4.95
350-0-350v @ 45 ma.; 675v @ 5 ma.; 2 1/2v @ 2A; 2x6.3v @ 1A; 6.3v @ 2 1/4A.....	4.95
350-0-350v @ 80 ma.; 6.3v @ .6A; 6.3v @ 3.75A; 2x5v @ 3A.....	3.98
385-0-385-550v @ 200 ma.; 2 1/2v @ 2A; 5v @ 3A; 8x6.3v @ 6A—PRI. 110/220.....	7.95
350-0-350v @ 150 ma.; 5v @ 3A; 6.3v @ 7.5A; 6.3v @ 3A.....	4.95
350-0-350v @ 35 ma.....	1.49
340-0-340v @ 300 ma.; 1540v @ 5 ma.....	5.95
335-0-335v @ 60 ma.; 5v @ 3A; 6.3v @ 2A; 0-13-17-21-23v @ 70 ma.—PRI. 110/220.....	4.95
325-0-325v @ 120 ma.; 10v @ 5A; 5v @ 7A.....	3.49
300-0300v @ 65 ma.; 2x5v @ 2A; 6.3v @ 2 1/4A; 6.3v @ 1A.....	3.49
250-0-250v @ 100 ma.; 2x6.3v @ 4A; 6.3v @ 5A; 6.3v @ 1A.....	4.95
120-0120v @ 50 ma.....	.98
80-0-80v @ 225 ma.; 5v @ 2A; 5v @ 4A.....	3.95
24v @ 6A.....	3.50
13.5 CT @ 3.25A.....	2.95
3x10.3v @ 7A; CT.....	9.95
12.6v CT @ 10A; 11v CT @ 6.5A.....	7.95
6.3v @ 10A; 6.3v @ 1A.....	3.50
6.3v @ 1A; 2 1/2v @ 2A.....	3.45
6.3v @ 2 1/4A; 6.3v @ 2A; 2 1/2v @ 2A.....	5.95
5v—190A..... 17.50	6.3v @ 1A..... 98
5v—115A..... 14.95	8v CT 1A..... 98
5v @ 20 amp.; Primary 110/220v.....	3.95
6.3v CT @ 3A; 5v CT @ 4A.....	4.25

## TELEGRAPH KEY J45

Fully adjustable. Silver contacts and 5 ft. rubber cable, with PL-55 plug.  
Brand New..... **69c each**

## 2 SPEED PLANETARY DRIVE

Fits condenser shaft back of panel, or dial knob shaft. 5 to 1 and 1 to 1 ratios. For any 1/4" shaft.  
Special 79c ea..... **2 for \$1.50**

## FILTER CHOKES

### HI-VOLTAGE INSULATION

10 hy @ 400ma.....	\$4.95	325 hy @ 3ma.....	\$ 3.49
8 hy @ 300ma.....	3.95	1 hy @ 800ma.....	14.95
25 hy @ 160 ma.....	3.49	10 hy @ 250 ma.....	2.49
12 hy @ 150 ma.....	2.25	10 hy @ 200 ma.....	1.98
12 hy @ 100 ma.....	1.39	10/20 @ 85 ma.....	1.59
30 hy @ 70 ma.....	1.39	15 hy @ 125 ma.....	1.49
.05 hy @ 15 amps.....	7.95	15 hy @ 100 ma.....	1.39
.1 hy @ 5 amps.....	6.95	3 hy @ 50 ma.....	.29
4 hy @ 600 ma.....	5.95	30 hy Dual @ 20 ma.....	1.49
200 hy @ 10 ma.....	3.49	8/30 hy @ 250 ma.....	3.50
600 hy @ 3 ma.....	3.49	10 hy @ 100 ma.....	1.20

## ATTENTION!

INDUSTRIALS—LABS—SCHOOLS  
—AMATEURS

Let us quote on components and equipment that you require. We have too many items to be listed on this page. Place your name on our mailing list now for new catalog.

# RADIO HAM SHACK Inc.

63 DEY STREET • NEW YORK 7, N. Y.

## BRAND NEW SURPLUS

Not "Like-New," or "Just-As-Good-as-New,"  
but BRAND NEW. Pay a little more—  
GET THE BEST

## 15" SPEAKERS

• Cineadagraph Dynamic Speaker with  
12,500-ohm Field Coil, made for heavy-  
duty P-A Systems, etc. Superb phono item.  
Brand new, of course! Reg. price \$47.50. **\$13.95**

### WHILE THEY LAST

## PE-103 DYNAMOTORS

LAST LOT! Brand New—in moisture-proof sealed pack-  
ing. 6 or 12v input; 500v, 160ma output. Complete  
with filters, circuit breakers, etc. GET THE FINEST IN  
UNOPENED CASES. **\$10.95**

## FL-8A FILTER

*LISTEN ONLY to the Signal You WANT to Hear*



Improves ANY receiver! 1020 cps Filter, connects  
between output of receiver and phones or speaker.  
Hear only ONE signal at a time. Cuts out interference  
and background noise. AMAZING PERFORMANCE!  
Complete with cards, phone plug and extension con-  
nector. BRAND NEW, made by UTC. War Surplus Item  
Original cartons. POSTPAID. **\$2.95**

### Brand New! TS-13 HANDSETS



Cradle-Type Black Bakelite Tele-  
phone Handset, with low-impedance  
carbon mike and 3,000-ohm ear-  
phone, 6-ft. cord and two plugs.  
Butterfly push-talk switch. Brand New,  
in Original Sealed Cartons.  
LOWEST PRICE IN U. S. A.  
Only **\$2.85** net  
Hanger for TS-13 Handset Black  
Cracked Metal. **\$1.95**

### POWER SUPPLY FOR ANY 274-N RECEIVER



Here it is—at last! Just plug it into  
the rear of your 274-N RECEIVER  
... any model! Complete kit, and  
black metal case, with ALL parts  
and diagrams. Simple and easy to  
build in a jiffy. Designed especially  
for the 274-N receiver (Resistance-filter KIT \$6.95)  
Standard model has choke filter. **\$7.95**

### NAVY SPARE-PARTS CHEST WITH MANY FINE PARTS

• At least \$25.00 worth of  
BRAND NEW, excellent parts,  
and a plywood chest, gray  
lacquered, with lift compart-  
ment, handles and hasp, at a  
give-away price... **\$4.95** net!  
Chest contains audio xfmrs,  
chokes, many standard resis-  
tors, mica condensers, oil con-  
densers, coils, relay parts, wire-  
wound rheostats, 3 Type 78 Tubes, 2 Type 77 and  
1 RCA-1642. EVERYTHING BRAND NEW!  
VERY FEW ON HAND. Air-Mail your order **\$4.95**



- Eimac VT-127A Tubes, \$2.45 each, **Four for \$8.40**
- Power Supply Kit for BC-221 Frequency Meter **5.85**
- 12" PM Alnico-5 Speaker **7.85**

WRITE FOR FREE CATALOG 89-R

- 4-Hour Mail Order Service.

Send 25% Deposit, Balance COD.

## OFFENBACH & REIMUS CO.

372 Ellis St.

San Francisco 2, Calif.

# The Audio Engineering Society

**A group of forward-thinking audio men have banded together to stimulate and improve audio standards.**

By **LEWIS S. GOODFRIEND**

Research Eng., Stevens Institute of Technology

**T**HE *Audio Engineering Society*, organized in February of this year at New York, has already made rapid strides in bringing together members of the audio profession for the purpose of discussing, organizing the existing knowledge, and promoting the intelligent study of problems in the field of audio engineering. Since most of the readers of *RADIO NEWS* design or operate audio equipment, the society and its activities are of essential interest. It is with this in mind that the following review is presented.

For the past few years men engaged in audio engineering have found themselves eligible for membership in one of four major professional societies, but in each of these societies "audio" was merely a minor item. Papers and reports on audio subjects seldom found their way into the journals or on the agenda at meetings of these societies. It is a matter of common knowledge that technical developments in the audio field have gone far beyond the material currently available. In order to offset this situation prominent audio men have, from time to time, organized small local groups where they could discuss audio and exchange ideas, the most prominent of these organizations being the *Sapphire Group* in Hollywood. A few publications, among them *RADIO NEWS*, published articles on audio, but this was an exception, not the general case. However, it was not until a year ago, in the summer of 1947, that any action to form a professional society for audio men received any great impetus. It was at that time that C. J. LeBel, New York consultant, first began to discuss the need for such a society with other prominent members of the audio field. Audio development had made great strides, yet many professional and scientific journals gave even less space than previously to the subject. Mr. LeBel's activity was rewarded by the formation of a committee including four other audio men. They are Norman C. Pickering, John D. Colvin, Charles G. McProud, and C. A. Rackey. It was this committee, whose members took time from their professional duties, that finally succeeded in getting the society started.

In January the committee organized a meeting of audio engineers in the New York area, and on February 17 over 200 audio men met and listened to discussions by LeBel and Pickering on the needs and aims of a professional society of audio engineers. The group in attendance agreed with the two speakers and a motion was carried to form the *Audio Engineering Society*. In order to carry forward the business of the new society, the original committee was empowered to continue its activity.

Since its formation, the society has adopted a constitution and By-Laws, elected officers, and held three technical meetings. Officers of the new Society are the members of the original committee: Mr. LeBel as President; with Mr. Pickering as Secretary, and with the addition of R. A. Schlegel as Treasurer.

The first Technical Meeting featured a paper by Dr. Harry F. Olson, of the *RCA Laboratories*, Princeton, New Jersey. Dr. Olson spoke on "Problems of High Fidelity Reproduction," describing three specific problems involving phonograph transducers, noise suppressors, and loudspeakers. He illustrated his paper with slides showing the dynamical analogies involved, and a demonstration of the equipment resulting from his solution of the problems. At the May Meeting of the Society Herschel Toomin, noted for his work in the study of magnetic recording media, delivered a paper describing a new sweep frequency generator capable of showing the frequency response of an audio system on an oscilloscope screen with true logarithmic frequency scale, and either a linear or decibel scale for vertical presentation. The instrument described has frequency markers and variable high and low frequency limits so that it may be used for specific narrow-band audio systems, as well as wide range equipment, without modification.

The third technical paper presented to the Society was by Colonel Richard H. Ranger, President of *Rangertone*, and Chairman of the Society's membership committee. Colonel Ranger spoke on various problems of the magnetic recording field, and indicated that theory has not yet come abreast of experimental work. However, he

**RADIO & TELEVISION NEWS**

**TUBES ARE KNOWN BY**

**THE COMPANY THEY KEEP**

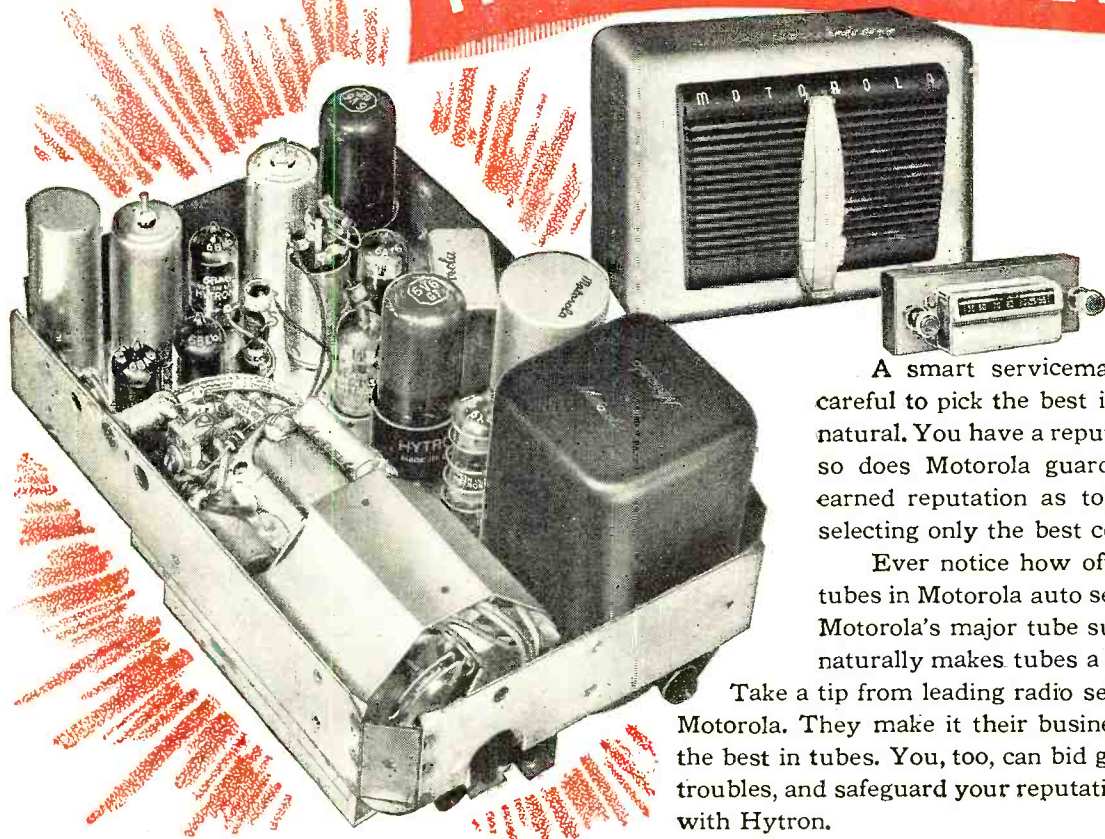

A smart serviceman, you are mighty careful to pick the best in tubes. That's only natural. You have a reputation to protect. Just so does Motorola guard jealously its well-earned reputation as tops in auto radio by selecting only the best components.

Ever notice how often you find Hytron tubes in Motorola auto sets? To rate as one of Motorola's major tube suppliers, Hytron just naturally makes tubes a lot better than good.

Take a tip from leading radio set manufacturers like Motorola. They make it their business to know and use the best in tubes. You, too, can bid goodbye to your tube troubles, and safeguard your reputation by "going steady" with Hytron.

**SERVICEMEN—Win These Monthly Prizes!**



FIRST PRIZE, AUG.

McMurdo Silver 900A "Vomax," 904 C/R Tester, and 905A "Sparx."

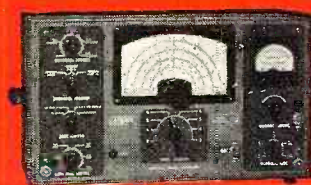

FIRST PRIZE, SEPT.

Jackson 641 Universal Signal Generator.



FIRST PRIZE, OCT.

Weston 769 H-F Electronic Analyzer.



Want one of these deluxe first prizes? Perhaps a \$200 U. S. Savings Bond grand prize? Or one of three \$50 and three \$25 U. S. Savings Bond second and third prizes? Try your hand at any or all of Hytron's monthly contests exclusively for radio servicemen. It's easy. Here's how. Get entry blank

with complete details from your Hytron jobber, or write us. Describe your proposal for a simple, economical shop tool like the Hytron Tube Tapper or Miniature Pin Straighteners. Mail entry to Hytron Contest Editor. Then hold your breath. The finger of the judges may point at you.

SPECIALISTS IN RADIO RECEIVING TUBES SINCE 1921



**HYTRON**  
RADIO AND ELECTRONICS CORP.

MAIN OFFICE: SALEM, MASSACHUSETTS

NEW 9-PIN  
Miniature Pin Straightener



Only 49¢ at Hytron jobbers

**RADIOMEN!**

**GET THIS**

**Brand New!**

**Valuable Book**

**OF "150 NEW**

**RADIO DIAGRAMS**

**EXPLAINED"**

**FREE**



**10 to 1 Satisfaction**  
**GUARANTEE**

"I personally guarantee that at the end of 1 year from date of receipt, my Applied Practical Radio set will have earned for you at least 10 times its cost, or you may return it and I'll return every cent you paid."

B. W. Cooke, Pres.



Here's a sensational "get acquainted" offer! This big, new book, "150 New Radio Diagrams Explained" is yours, absolutely FREE! It contains circuits and data on the latest Radio and Television sets. Easy-to-read, 8 1/2 x 11" size, with full instructions on how to read and use diagrams. Belongs in every radioman's kit.

**HOW TO GET YOUR FREE BOOK**

You can get this book Free just for looking over — without cost or obligation — the sensational new 5-volume Coyne set "APPLIED PRACTICAL RADIO." It's just off the press. Here's everything you want to know about radio, from basic principles to up-to-the-minute Television and FM! PA, shortwave, aviation-auto radio, multibands, tele-transmission testing instruments and trouble-shooting short cuts, phototubes, etc., all clearly explained.

Shows how to construct, install, service all types of apparatus. Step-by-step photos break equipment down before your eyes! Newest testing methods. Hundreds of subjects, over 1500 pages, almost 1000 illustrations, diagrams. Written for home training and field reference — so complete, so up-to-date and practical that every man interested in radio should see it.

**SEND NO MONEY** You can see how much this set can mean to your future, without cost or obligation. I'll send "APPLIED PRACTICAL RADIO" postpaid, for you to look over for 7 days FREE—and with it, the Radio and Television Diagrams book as an outright Gift! This book is yours to keep free whether or not you decide to keep the 5-Volume Set! In 7 days, either return the 5-Book Set and owe nothing or pay \$3 then and \$3 a month until \$16.75 is paid. Or you can save \$1.75 by paying \$15.00 cash price.

**Use Coupon Now!**

YOU ARE NOT BUYING THE 5-VOLUME SET WHEN YOU SEND THIS COUPON. You are merely asking to see the books free for 7 days. Free Book Offer is limited — so mail coupon today.

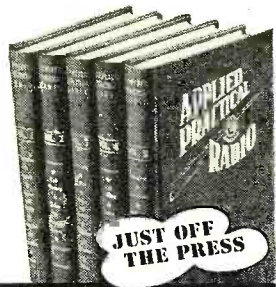

**JUST OFF THE PRESS**

**FREE BOOK COUPON**

B. W. Cooke, Pres., Coyne Electrical & Radio School, 500 S. Paulina St., Dept. 68-T3 Chicago 12, Illinois

Send me the NEW 5-volume Coyne Set, "APPLIED PRACTICAL RADIO" for 7 days FREE examination per your offer. Also send "150 New Radio Diagrams Explained" as a FREE gift.

NAME ..... AGE .....

ADDRESS .....

TOWN ..... ZONE ..... STATE .....

pointed out that through experimental work, an extremely high quality magnetic system is possible.

What exactly is the need for any professional Society? The members of the *Audio Engineering Society* decided that there was a need for their organization for the following reasons: "The diffusion and increase of educational and scientific knowledge in audio engineering and the promotion and advancement of this science and its allied arts in both their theoretical and practical applications, and the stimulation of interest in audio engineering, the interchange and inter-course of ideas and the promotion and maintenance of high professional standards among its members." In order to carry out these aims, the Society must hold meetings for the reading of professional papers, publications, communications, and such other professional activity as is necessary.

Among other things the members feel that the Society must remain independent of any other organization or any commercial interest, and although commercial groups may become sustaining members, make donations of space or material, or act to publish the Society's activities, they may have no vote in the operation and conduct of the Society's affairs.

Among the branches of audio engineering in which the Society has a large number of members and about which there is little published information are: speech input system, studio design and use, disc recording, tape and wire recording, hearing aids, public address systems, high quality home reproduction systems, wired music systems, and telephone engineering.

Besides these subjects to be covered by the Society's activity, there are certain obligations that the Society has to the art, including the development of a public appreciation of audio engineering as a separate art, the fostering of research on basic problems in the field, facilities for publication of papers and the holding of meetings on audio engineering, the fostering of education and guidance of education in the audio engineering field, along with the preparation of standards, cooperative research, and standards work not only in audio but with other groups working in closely allied fields. It is with these ideas in mind that the Executive Committee is proceeding with its work. Plans under way call for a meeting of the national organization in October, and the preparation of material to assist in the organization of local sections throughout the country. It is hoped that the local sections will be able to carry on in the fall in a manner similar to the New York section this past spring, holding technical meetings, panel discussions, and contributing papers to the Society's own publication which will be arranged for the fall.

ED. NOTE: There is no official Society publication, nor affiliation with any magazine at this writing.

Membership in the *Audio Engineering Society* is open to men of all educational and professional levels from the student through the professional design engineer and manufacturing executive.

Inquiries concerning membership or membership applications should be addressed to Norman C. Pickering, Secretary, Box F, Oceanside, N. Y. —50—

**BELL LABS INTRODUCES A REVOLUTIONARY COMPONENT**

**BELL** Telephone Laboratories has demonstrated a new device which may have far-reaching significance in electronics and electrical communications.

Known as the "Transistor," the new unit is capable of performing efficiently nearly all of the functions of an ordinary vacuum tube. The "Transistor" works on an entirely new physical principle which was discovered in the course of fundamental research into the electrical properties of solids.

The whole apparatus is housed in a tiny cylinder less than an inch long. It will serve as an amplifier or an oscillator, yet bears almost no resemblance to the vacuum tube now used to do these jobs. It has no vacuum, no glass envelope, no grid, no plate, no cathode, and therefore no warm-up delay.

Two hair-thin wires touching a pin-head of a solid semi-conductive material soldered to a metal base, are the principal parts of the "Transistor." These are enclosed in a simple, metal cylinder not much larger than a shoe-lace tip.

Tests have shown that the "Transistor" will amplify at least 100 times (20 db.). Some test models have been operated as amplifiers at frequencies up to 10 million c.p.s.

Key investigations which led to the development of the "Transistor" were carried out by Dr. John Bardeen and Dr. Walter H. Brattain. The general research program leading to the development was initiated and directed by Dr. William Shockley.

Bell Laboratories advises that the device is still in the experimental stage and that no data on cost is presently available. —50—

Relative size of the new Bell Labs "Transistors" can be seen by comparison with pencil.

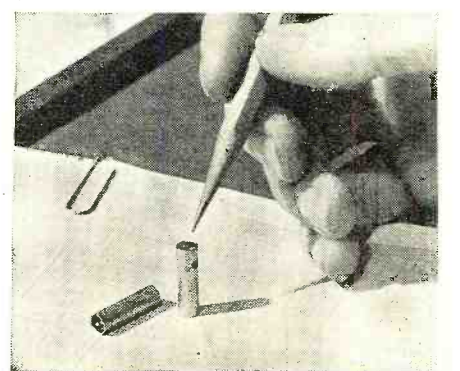

**Buy** WHERE YOU SEE **THIS BANNER**  
 . . . because **IT'S BETTER FOR YOU!**

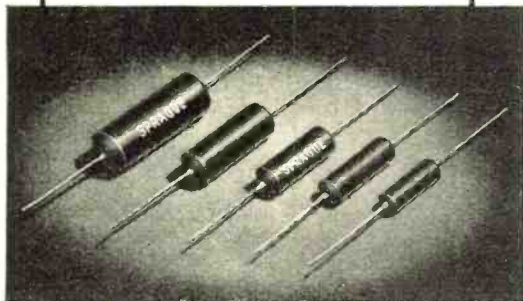

**SPRAGUE TM TUBULARS**  
 The first truly practical MOLDED Paper Tubulars! Now in stock—ready for your use—See your SPRAGUE Distributor.



**SPRAGUE ATOMS—DRY ELECTROLYTICS**  
 You can make up virtually any required capacity-voltage combination with a small stock. Keep a representative supply in your shop. **SAVE TIME—SAVE MONEY—SAVE SPACE!**



**SPRAGUE EL SELF-MOUNTING MIDGET CAN CAPACITORS**  
 No other Dry Electrolytic gives so much dependability in so small a space! Tinned, Twist-Prong Tabs for easy soldering; quick, universal self-mounting. **SAVES TIME—SPEEDS RELIABLE SERVICE!**



Yes, it's better for you *and your business* to buy where this banner is displayed because the **SPRAGUE BANNER** identifies a Distributor who agrees that "*It's foolish to play penny-ante when your business is at stake!*"

Your Sprague Distributor is a successful business man. He knows the parts business intimately—and he knows that to really build a bigger, more successful service business, you should use only the best replacement parts. That's why he features Sprague Capacitors and \*Koolohm Resistors. His business depends on your success and he wants you to remember that **YOUR REPUTATION AND YOUR CUSTOMERS ARE TOO VALUABLE TO RISK FOR THE FEW PENNIES "SAVED" BY BUYING INFERIOR OR UNKNOWN "BARGAINS"!**

Reach for a **SPRAGUE**  
 and Know You're Right!



Yes! We're Listed in the **RED BOOK**

Looking for the correct Sprague replacement capacitors for any receiver manufactured from 1938 to 1948? It's easy—just refer to The Radio Industry **RED BOOK** . . .



CAPACITORS

**SPRAGUE**

\*KOOLOHM RESISTORS

\*T.M. Reg. U.S. Pat. Off.

*It's Only Natural*

**FOR RADIO MEN TO ASSEMBLE THEIR OWN**

**Heathkit ELECTRONIC SWITCH KIT**  
DOUBLES THE UTILITY OF ANY SCOPE



**\$34.50**

Gives two separately controllable traces with individual inputs on any scope. See both the input and output traces, locate distortion, phase shift, etc., immediately. Individual gain controls and positioning control. Coarse and fine sweeping rate controls. Complete Heathkit matches others, with 5 tubes. All metal parts are punched, formed and cadmium plated. Complete with tubes, all parts, detailed blueprints and instructions. Shipping Wt. 13 lbs.

**Nothing ELSE TO BUY**

- ★ Save 1/3 the cost.
- ★ Gain valuable knowledge.
- ★ Achieve better workmanship.
- ★ Learn many new applications.
- ★ Ideal training for use.

Heathkits are regular factory quality test equipment unassembled but with all forming, punching, calibrating and printing already completed.

**HEATHKIT CONDENSER CHECKER KIT**

A condenser checker anyone can afford to own. Measures capacity and leakage from .00001 to 1000 MFD on calibrated scales with test voltage up to 500 volts. No need for tables or multipliers. Reads resistance 500 ohms to 2 megohms. 110V 60 cycle transformer operated complete with rectifier and magic eye indicator tubes. Easy quick assembly with clear detailed blueprints and instructions. Small convenient size 9" x 6" x 4 3/4". Weight 4 pounds. This is one of the handiest instruments in any service shop.



**\$19.50**  
*Nothing ELSE TO BUY*

**THE NEW HEATHKIT VACUUM TUBE VOLTMETER KIT**

The most essential tool a radio man can have, now within the reach of his pocketbook. The Heathkit VTVM is equal in quality to instruments selling for \$75.00 or more. Features 500 microamp meter, transformer power supply, 1% glass enclosed divider resistors, ceramic selector switches, 11 megohms input resistance, linear AC and DC scale, electronic AC reading RMS. Circuit uses 6SN7 in balanced bridge circuit, a 6H6 as AC rectifier and 6 x 5 as transformer power supply rectifier. Included is means of calibrating without standards. Average assembly time less than four pleasant hours and you have the most useful test instrument you will ever own. Ranges 0-3, 30, 100, 300, 1000 volts AC and DC. Ohmmeter has ranges of scale times 1, 100, 1000, 10M and 1 megohm, giving range .1 ohm to 1000 megohms. Complete with detailed instructions. Add postage for 8 lbs.

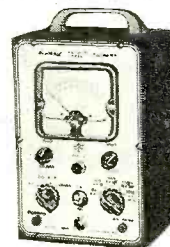

**\$24.50**  
*Nothing ELSE TO BUY*

**HEATHKIT SIGNAL GENERATOR KIT**

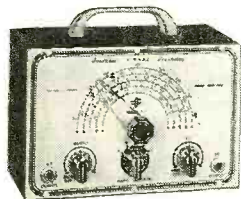

**\$19.50**  
**NOTHING ELSE TO BUY**

Every shop needs a good signal generator. The Heathkit fulfills every servicing need, fundamentals from 150 Kc. to 30 megacycles with strong harmonics over 100 megacycles covering the new television and FM bands. 110V 60 cycle transformer operated power supply. 400 cycle audio available for 30% modulation or audio testing. Uses 6SN7 as RF oscillator and audio amplifier. Complete kit has every part necessary and detailed blueprints and instructions enable the builder to assemble it in a few hours. Large easy to read calibration. Convenient size 9" x 6" x 4 3/4". Weight 4 1/2 pounds.

**HEATHKIT SIGNAL TRACER KIT**

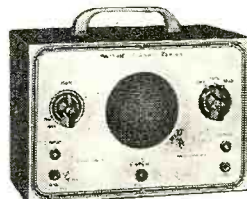

**\$19.50**  
*Nothing ELSE TO BUY*

Reduces service time and greatly increases profits of any service shop. Uses crystal diode to follow signal from antenna to speaker. Locates faults immediately. Internal amplifier available for speaker testing and internal speaker available for amplifier testing. Connection for VTVM on panel allows visual tracing and gain measurements. Also tests phonograph pickups, microphones, PA systems, etc. Frequency range to 200 Mc. Complete ready to assemble. 110V 60 cycle transformer operated. Supplied with 3 tubes, diode probe, 2 color panel, all other parts. Easy to assemble, detailed blueprints and instructions. Small portable 9" x 6" x 4 3/4". Wt. 6 pounds. Ideal for taking on service calls. Complete your service shop with this instrument.

**HEATHKIT SINE AND SQUARE WAVE AUDIO GENERATOR KIT**

The ideal companion instrument to the Heathkit Oscilloscope. An Audio Generator with less than 1% distortion, high calibration accuracy, covering 20 to 20,000 cycles. Circuit is highly stable resistance capacity tuned circuit. Five tubes are used, a 6SJ7 and 6K6 in the oscillator circuit, a 6SL7 square wave clipper, a 6SN7 as a cathode follower output and 5Y3 as transformer power supply rectifier. The square wave is of excellent shape between 100 and 5,000 cycles giving adequate range for all studio, FM and television amplifier testing. Either sine or square wave available instantly at a toggle switch. Approximately 25V of sine AC available at 50,000 ohm output impedance. Output  $\pm 1$  db. from 20 to 20,000 cycles. Nothing else to buy. All metal parts are punched, formed and cadmium plated. Complete with tubes, all parts, detailed blueprints and instructions.

**\$34.50**  
Shipping Wt., 13 lbs.

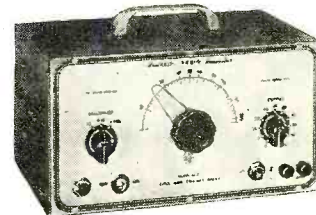

**The HEATH COMPANY**

**DEPT. N . . . BENTON HARBOR, MICHIGAN**

# TEST EQUIPMENT

## NEW 1948 HEATHKIT 5" OSCILLOSCOPE KIT

A necessity for the newer servicing technique in FM and television at a price you can afford. The Heathkit is complete, beautiful two color panel, all metal parts punched, formed and plated and every part supplied. A pleasant evening's work and you have the most interesting piece of laboratory equipment available.

Check the features — large 5" 5BPT tube, compensated vertical and horizontal amplifiers using 6SJ7's, 15 cycle to 30 M cycle sweep generator using 884 gas triode, 110V 60 cycle power transformer gives 1100 volts negative and 350 volts positive.

Convenient size 8½" x 13" high, 17" deep, weight only 26 pounds.

All controls on front panel with test voltage and ext. syn post. Complete with all tubes and detailed instructions. Shipping weight 33 pounds. Order today while surplus tubes make the price possible.

**\$39.50**

Nothing ELSE TO BUY

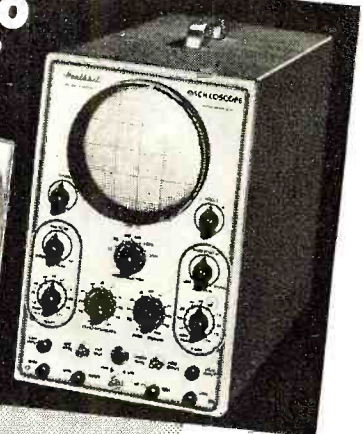
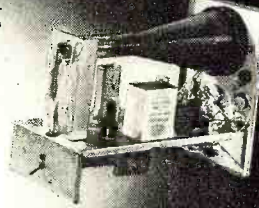

## HEATHKIT HIGH FIDELITY AMPLIFIER KIT

**\$14.95**

Build this high fidelity amplifier and save two-thirds of the cost. Push pull output using 1619 tubes (military type 6L6's), two amplifier stages using a dual triode (6SN7), and a phase inverter give this amplifier a linear reproduction equal to amplifiers selling for ten times this price. Every part supplied, punched and formed chassis, transformers (including quality output to 3-8 ohm voice coil), tubes, controls, and complete instructions. Add postage for 20 lbs.



12" PM speakers for above ..... \$6.95

## HEATHKIT 3-TUBE ALL-WAVE RADIO

110-volt AC operation

**\$8.75**

An ideal way to learn radio. This kit is complete ready to assemble, with tubes and all other parts. Operates from AC. Simple, clear detailed instructions make this a good radio training course. Covers regular broadcasts and short wave bands. Plug-in coils. Regenerative circuit. Operates loud speaker. Add postage for 3 lbs.



HS 30 Headphones per set ..... \$1.00  
2½" permanent magnet loudspeaker ..... \$1.95

## INTERPHONE 2-WAY CALL SYSTEM KIT

Ideal call and communication system for homes, offices, factories, stores, etc. Makes excellent electronic baby watcher, easy to assemble with every part supplied including simple instructions. Distance up to 1/5 mile. Operates from 110 V.A.C. 3 tubes, one master and one remote speaker. Shipping Weight 5 pounds.

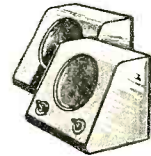

**\$14.50**



## HEARING AID HEADPHONES

The Army's best — eliminate flat ears and outside noise. Complete with transformer for conversion from low to high impedance. With cord and plug complete. Add postage for 1 lb.

**\$1.00**

## COMMAND SET ACCESSORIES

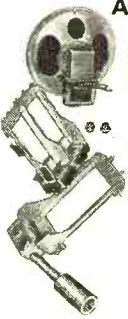

### 5" PM SPEAKER

With output transformer, matching headphone output

**\$2.80**

### Dual receiver rack FT277A

with connecting plugs

**\$1.00**

### Single transmitter rack FT234A

**\$1.00**

### SPLINE SHAFT FOR TUNING COMMAND RECEIVERS

Allows use of regular tuning knob on BC 453-4-5 receivers

**39c**

## POWER TRANSFORMER *Specials*



Primary 117V 60 cycle. Secondaries supply 746 V.C.T. at 220 MA, 6.3V at 4.5 A., and 5V. at 4 A. Will handle 13 tube radio receivers. Supply is limited, order early. Shipping Wt. 11 lbs. each.

**\$3.95** ..... 3 FOR **\$9.95**

## OUTPUT TRANSFORMER

Push pull 6V6's to 6-8 ohm voice coil excellent characteristics. No. 800



3 FOR **\$1.95**

## TRANSMITTER TRANSFORMER

The transformer from Transmitter Power Supply listed below, 600 Volt at 200 MA and 4 Amp. filaments of 3 to 24 Volts. Also 5 Volts at 4 Amperes for rectifier. Shipping Wt. 12 lbs.



**\$9.50**

## MILITARY POWER TRANSFORMERS

Convert your military receivers without rewiring the filament. "A" type supplies 500 VCT at 50 MA, 5V at 2A and 24V at ½ A. "B" type supplies 500 VCT at 50 MA, 5V at 2A and 12V at 1 Amp. State whether A or B type desired. Ship. Wt., 4 lbs.



**\$2.95**



## METER *Special*

Brand new DeJur Model 312 0-800 M.A. D.C. Square 3" 0-10 M.A. basic meter with built in shunt. Probably the best buy ever offered in a surplus meter. Shipping Wt., 1 lb.

**\$2.95**

## BALLENTINE 6 VOLT DYNAMOTOR

Dynamotor only from PE 103 power supply. Input 6 or 12 Volts, output 500 Volts at 160 MA. Brand new original cartons. Shipping Wt. 29 lbs.



**\$5.95**

## T32 TABLE MICROPHONE

One of the Army's best. Built by Kellogg, ideal for factory call system, public address, amateur use. Brand new in original cartons, add postage for 5 lbs.

**\$2.95**



## 110 V. A.C. TRANSMITTER POWER SUPPLY KIT

For BC-645, 223, 522, 274N's, etc. Ideal for powering military transmitters. Supplies 500 to 600 Volts at 150 to 200 MA plate, 6.3 C.T. at 4 Amps, 6.3 at 4 Amps and 12V at 4 Amps. Can be combined to supply 3-6-9-12 or 24 Volts at 4 Amperes. Kit supplied complete with husky 110V 60 cycle power transformer, 5U4 rectifier, oil filled condensers, cased choke, punched chassis, and all other parts, including detailed instructions. Complete — nothing else to buy.

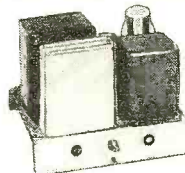

**\$14.50**

## 110 V. A.C. MILITARY RECEIVER POWER SUPPLY KIT

Ideal way to convert military sets. Supplies 24 Volts for filament — no wiring changes inside radio. Also supplies 250 V. D.C. plate voltage at 50-60 MA. Connections direct to dynamotor input. Complete with all parts and detailed instructions. Ship. Wt., 6 lbs.

**\$ 5.95**

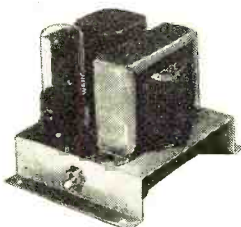

**The HEATH COMPANY**

**DEPT. N . . . BENTON HARBOR, MICHIGAN**

*All Mail Orders Shipped Promptly!*

**SAVE ON THESE MONEY-SAVING VALUES!**

**NEW! WEBSTER MODEL NO. 133 33 1/3 RECORD CHANGER**

Specially designed for new Columbia 300 lines per inch records. Undistorted fidelity. To be used in conjunction with your phonograph combination. **\$38.75** *List East of the Rockies*



**NEW DELUXE AC 10 WATT TRUSOUND HI FI AMPLIFIER**

The H F 10 Amplifier is a general-purpose amplifier (only 6" x 9" x 7") designed for highest quality reproduction of sound, music and speech. It is engineered and manufactured to meet the highest quality standards required when used in conjunction with the new High Fidelity Pickups, FM, AM, Tuners and Mikes.

Complete with tubes and cover. **\$29.95**

- 10 Watts undistorted 17 Watt peak.
- Inputs for low level pick-ups, tuners and mikes.
- Selector switch for rapid change-over to input circuits.
- Low hum level—70 db. below 10 watts.
- Separate bass and treble controls.
- Treble . . . from plus 10 db. to minus 15 db. at 10,000 CPS.
- Bass . . . from plus 10 db. to minus 15 db. at 50 CPS.
- 2, 4, 8, 16 and 50 ohm output.
- Constant duty oversized transformers and parts throughout.

**2 TUBE WIRELESS PHONO OSCILLATOR**

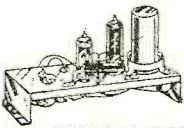

This fine piece of equipment is being sold at almost the price of the tubes alone. A real bargain while quantity lasts. Each **\$3.25**

**METAL CAN AEROVAX REPLACEMENT FILTER CONDENSERS**

Replaces 8x8 at 600 working volts. DC test volt 800. Each . . . \$1.29  
10 for . . . . . 11.75



**CIRCULAR 35 WATT FLUORESCENT LIGHT FIXTURE**

Complete with G.E. Ballast starter and bulb. Ideal for kitchen, bathrooms, bedrooms and shops. Available in flush ceiling mounting or 4" cup adaptor mount. Each **\$16.95**

**"ULTRA MIKE" WIRELESS MICROPHONE**

Light — Economical operation. Completely self contained. No connections to power lines. Complete with batteries, tubes, etc. Retail at . . . . . \$18.00  
Your price, **\$6.63**  
Each



**SIGNAL CORPS OUTPUT METER "146"**

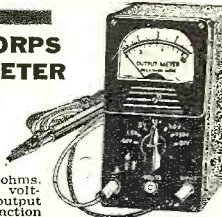

A war surplus bargain made by Triplett for the U.S. Army. Meter has 5 ranges, 1 1/2 v. 6v. 15v. 60v. 150v. Meter resistance 4000 ohms. Can be used on A.C. voltmeter as well as an output meter. Used in conjunction with a signal generator, the "146" is an invaluable aid in "sounding" your alignment jobs by indicating the intensity of the output of the radio, thus eliminating guesswork involved in trying to peak a set with ear alone. Complete with high quality test leads with clips and black moulded bakelite case measuring 8" x 3". **\$10.49**

**ALL NEW FULLY GUARANTEED STANDARD BRAND TUBES**

\$82A	.....	\$1.98
\$26	.....	.49
\$27A	.....	1.95
9001	.....	.75
9003	.....	.75
2D21	.....	.75
2X2	.....	.69

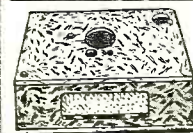

**RECORD PLAYER CASE**  
Simulated Leather Cover. 11"x13"x5". All holes punched. A real buy **59c**  
Each

**TERMS:** MINIMUM ORDER—\$3.00. 25% with order. Balance C.O.D., F.O.B. Chicago. Write for our FREE catalog.

*Mort's Radio Shack*

630 W. RANDOLPH STREET

CHICAGO 6, ILL.

**COMMAND RECEIVER ACCESSORIES**

For BC 453, 4, ARC-5, etc.

**B) Front Panel Adaptor**  
Contains gain control, B.F.O. switch and phone jack, completely wired and ready to work. Only **\$2.49** Postpaid and Your Unconverted Front Panel Adaptor.



**A) Tuning Control Knobs**  
Brand new—fits all series. Complete with locking sleeve. Makes tuning simple for mobile and station use. "Satisfied Users All Over the World!" **69c ea. 3 for \$2** Postpaid (Not illustrated) 85KC, 1415KC, 2830KC, B.F.O. transformers. F.B. for fixed, mobile converters & Q5R's.

**ALVARADO, Dept. 321**

903 S. ALVARADO

LOS ANGELES 6, CALIF.

**COMPLETE TELEVISION MANUAL**

**THE VIDEO HAND BOOK**

The vast amount of information contained in this book can only be briefly outlined here. The VIDEO HANDBOOK contains 768 pages—over 800 illustrations—thousands of vital facts—

- Sec. 1. Television, Past, Present, Future.
- Sec. 2. Fundamentals of Television.
- Sec. 3. The Television Station.
- Sec. 4. The Television Receiver.
- Sec. 5. The Television Antenna System.
- Sec. 6. Creating a Television Show.
- Sec. 7. Descriptions of Modern Television Receivers.
- Sec. 8. Installing Television Receivers.
- Sec. 9. Servicing Television Receivers.
- Sec. 10. Television Test Equipment.
- Sec. 11. Building a Television Receiver.
- Sec. 12. Data Section.
- Sec. 13. Television Terms.
- Sec. 14. Bibliography.

Publication Date, December. To make sure you get your copy of the Video Handbook, order now!

**SEND ORDER TO YOUR JOBBER, OR DIRECT TO:**

**\$5.00**

**BOLAND ROYCE INC., PUBLISHERS**

**MONTCLAIR 1, NEW JERSEY**



*Technical BOOKS*

**"TELEVISION AND F-M RECEIVER SERVICING"** by Milton S. Kiver. Published by *D. Van Nostrand Company, Inc.*, New York. 207 pages. Price \$2.95. Paper.

This latest text from Mr. Kiver's pen is a practical handbook for radio servicemen covering servicing procedures for television and FM receivers and installation techniques for video sets.

The book is divided into two main sections, the first dealing with television receivers while the second covers FM sets. Progression of the material is orderly and covers first of all the antenna system of the television receiver. The actual installation of the unit is next considered. Television test equipment is covered in a fairly comprehensive manner with essential equipment for servicing coming in for special attention. Four chapters cover the receiver itself and the author has devoted considerable space to a discussion of the principles of television before dealing with specific circuits and receivers. A particularly valuable chapter covers television receiver alignment techniques while the final chapter in the series covers the troubleshooting of television receiver faults.

The four chapters devoted to FM cover fundamentals, commercial FM receiver circuits, receiver alignment, and receiver servicing. An appendix giving a listing of TV channel allocations for various American cities completes the book.

RADIO NEWS readers need no introduction to Mr. Kiver's writing style. The clarity of presentation, typical of the author's work, makes this book invaluable for the serviceman both as a source book and as a ready-reference manual for on-the-job servicing problems.

\* \* \*

**"HOW TO USE DIAGRAMS IN RADIO SERVICING"** by M. N. Beitman. Published by *Supreme Publications*, Chicago. Available from publisher for 2 cent stamp.

This booklet gives many valuable hints on reading and understanding circuit diagrams. Because the publication also carries the publisher's index to "Most-Often-Needed Radio Diagrams and Servicing Information," the hints on using circuit diagrams are being made available virtually free of charge.

The index to the company's diagram manuals covers the periods from 1926 to 1948 and lists the receivers manufactured by well over one hundred companies.

Bound as a single 8 1/4 x 10 1/2 booklet, this publication is well worth the time spent in requesting it from the publisher.

-30-



CREI Training is Your  
**DOWN PAYMENT**  
 ON PROMOTION, MORE MONEY,  
 SECURITY



Train With One of America's  
 Foremost Technical Institutes

**RADIO-  
 ELECTRONICS!  
 TELEVISION!**

**CREI Training Can  
 Help You to a  
 Better-Paying Job!**

EVERY WEEK letters from students and graduates tell us of new pay increases and promotions that are made possible through the help of modern technical training with CREI.

Said one man recently: "... I am happy to report that in the past seven months with Station K - - -, I have received three increases in salary and a promotion which can be partly credited to CREI."

Hundreds of engineers and technicians with key positions in the radio industry, broadcasting, FM and Television owe their successful training to CREI. We are ready to help you in the same way we have been helping others for over 20 years.

Even if your radio experience is limited, there is a CREI course for you. CREI takes you all the way to a practical engineering level. CREI does

not drop you off at the elementary job training phase. You quickly advance lesson-by-lesson to the more advanced study of engineering principles and practice. The courses are practical, authoritative and easy to follow.

Your future success can be assured by the plans you make today. Just figure out for yourself how many good jobs are waiting for good men to fill them. These men must have modern training to handle intricate present day equipment. You can't say, "I don't need more training." Every radio man needs more training to increase his technical knowledge, no matter how limited or how great his experience.

Send for and read our 24-page booklet that explains our self-improvement program—our courses—and what we can do for you and your future. CREI courses are still available at pre-inflation prices and today give you more thorough instruction service per dollar than ever before—on convenient terms. It costs you nothing to read the facts. Please write today.



**Capitol Radio  
 Engineering Institute**

An Accredited Technical Institute

Dept. RN-9, 16th & Park Rd., N. W., Wash. 10, D. C.

Branch Offices: New York (7) 170 Broadway • San Francisco (2) 760 Market St.

September, 1948

**MAIL COUPON FOR FREE BOOKLET**

**CAPITOL RADIO ENGINEERING INSTITUTE**  
 16th and Park Road, N. W., Dept. RN-9, Washington 10, D. C.

Gentlemen: Please send your free booklet, "CREI training for your better job in Radio-Electronics," together with full details of your home-study training. I am attaching a brief resume of my experience, education and present position.

Check field of greatest interest:

- PRACTICAL RADIO-ELECTRONICS       PRACTICAL TELEVISION
- BROADCASTING       AERONAUTICAL RADIO ENGINEERING
- RECEIVER SERVICING       INDUSTRIAL ELECTRONICS

NAME \_\_\_\_\_

STREET \_\_\_\_\_

CITY \_\_\_\_\_ ZONE \_\_\_\_\_ STATE \_\_\_\_\_

I AM ENTITLED TO TRAINING UNDER G. I. BILL.

**IT'S SATISFACTION—  
or YOUR MONEY BACK at—**

**R & M RADIO**

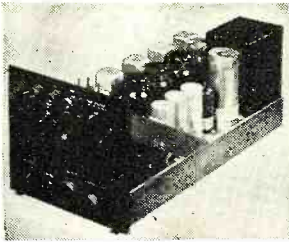

**APN-4 RCVR — 'SCOPE  
POWER SUPPLY**

4 switch-selected screw-driver tuned RF channels; IF freq. 1050 kc, band-width 45-60 kc; RF freq. 16 2000 kc. Tubes: (2) 2Y2, (3) 6B4, (4) 6SK7, (1) ea. 5U4, 6SU7, 6SA7, 6H6, VR150. Makes fixed tuner for med. freq. police calls or PA system. Has power supply for 5" scope, with 400 cycle trans. Electronic-controlled low v. supply; delivers 260 vdc. 150 mils reg. to .01%. Power supply alone worth more than price..... **\$12.50**

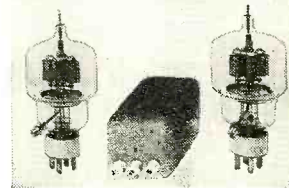

**GOOD FOR 2 KW.**

**SPECIAL COMBINATION**

Two 304-TL's; 1 filament transformer, primary 115 VAC, secondary No. 1, 5 v. at 12 amps; secondary No. 2, 5 v. at 12 amps. Use filaments in series or parallel.

**Individual Price:**

- 304-TL .....\$2.95
- 304-TL ..... 2.95
- Fil. Transformer..... 9.95

**ALL FOR \$14.50**

**COMBINATION BROADCAST RECEIVER &  
INTERCOM SYSTEM**

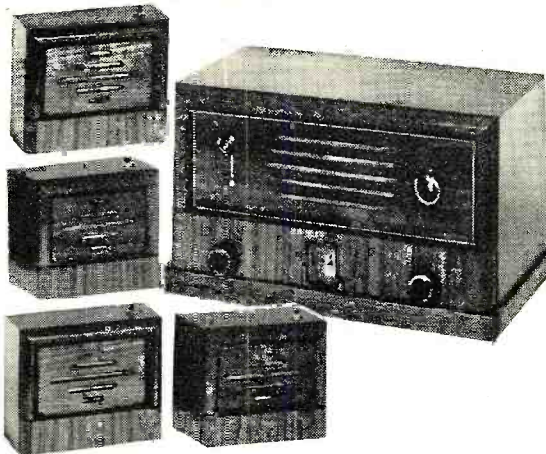

Price includes radio-master station, 1 remote, and 50 feet of wire

**BRAND NEW \$29.95**

**LIMITED QUANTITY**

Standard broadcast (6 tube superhet) receiver, plus home or office intercommunication system, walnut finish, modern design table model; high quality components; uses one to four remote stations. Any station can call the master while radio is playing; call can be returned to any remote. 115 v. AC; original list was \$84.50 (with 4 remotes). Additional remote stations, \$8.95 each.

**TRANSMITTERS & RECEIVERS FOR 10 Meter Mobile Rig**

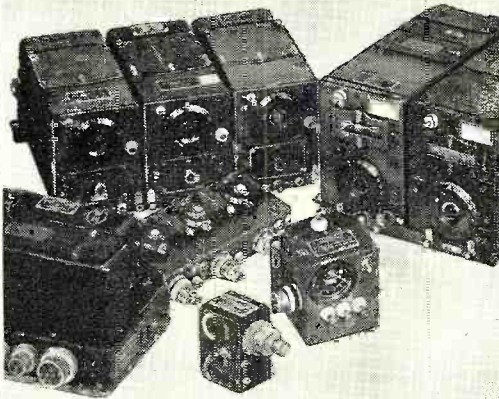

**SCR-274-N COMPLETE FOR ONLY**

Conversion Book gives details for low-cost, easy conversion to

**\$39.50**

- 10 METER MOBILE RIG
- 20 - 40 - 80 METER BANDS

This sensation of all surplus is not only an ideal 10 Meter Mobile Rig! It's a complete amateur radio station! Here are a few more ways to use the equipment included in this Command Set. The transmitter VFO driver stage gives your BC-375-E higher RF output—as high as 150 watts. Make swell standby receivers with the BC-348 on round-table "rag chews." You get all this equipment: 3 Receivers—190-550 kc, 3-6 and 6-9.1 mc; two transmitters, 4-5.3 mc, 5.3-7 mc; four dynamotors—28 volts DC input; 1 modulator with carbon mike input; two tuning control boxes; one antenna coupling box with r-f ammeter; antenna relay and 5000 volt 50 mmfd. WE vacuum condenser (antenna relay can be used with most rigs); and a complete set of tubes for each unit—29 POPULAR TUBES in all. Mechanical cables for remote tuning of receivers supplied for \$1.00 extra. Shipment from our nearest warehouse, East, Mid-West or West Coast.

**COST GOV'T OVER \$600.00** TUNING KNOBS for local control for receivers, 50c ea. Three for \$1.25

**BC-375-E TRANSMITTER**

WITH THOUSANDS OF USABLE STANDARD RADIO PARTS

(Gov't cost, \$1800)  
**\$49.50**  
complete

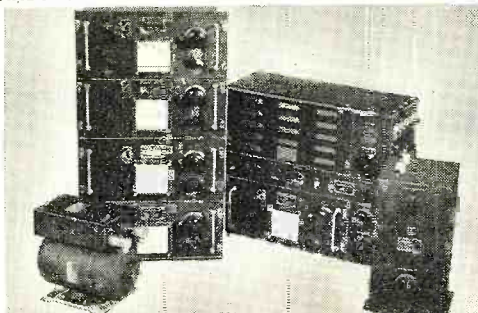

It's been written about and talked about—just the thing for beginner or old-timer: has five tubes, five tuning units. Xmtr. designed to operate from 200 kc. to 12 mc. (less BC band). Equipped with antenna tuning unit BC-306-A—variometer and tap switch. Dynamotor (PE-73-C) complete with relay, fuses and filter. Weight: approx. 275 lbs. Shipment from our nearest warehouse, East, Mid-West or West Coast

**THE FAMOUS "PUTT-PUTT"  
Gasoline Generator (HRU-28)**

28-32 Volts DC

Your Price Only **\$69.50**

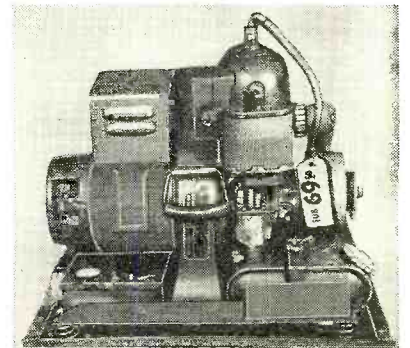

Single cylinder, 2 cycle gasoline engine with generator that is rated at 2000 watts direct current, 70 amps.

Has unlimited use around a farm or use as field day power supply. More literature upon request.

**RADIO & TELEVISION NEWS**

# 6-VOLT DYNAMOTOR

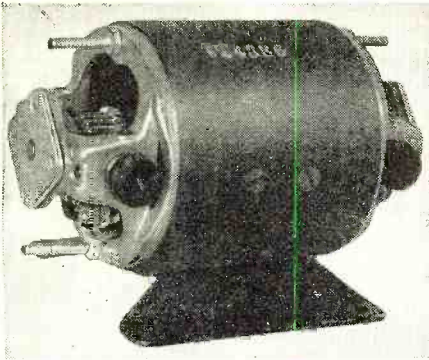

**Ideal for Mobile Operation**

(300 VDC 80 mills) 6 vol DC input  
(250 VDC 100 mills) 4 to 5 amps.

**\$7.95**

Just the dynamotor for that glove compartment 10 meter job. Sturdy, well made. 4"x 4"x 5" mounting space.

## 25 WATT FM- TRANSMITTER-RECEIVER

**\$29.50** for special combination

For mobile or fixed station use; easy conversion to 10 and 11 meters.

Schematic diagram and information—how to convert to 110 v. AC and amateur use.

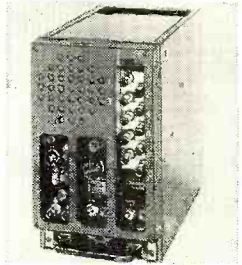

**BC-603  
RECEIVER**  
(alone)

**\$14.95**

10 tube, superhet FM receiver; Loster Seely discriminator, 10 channel; pre-tuned, push-button selector; optional manual tuning; adjustable squelch control; speaker mounted in receiver; freq. range 20 to 27.0 mc. Few small changes in RF patterns will cover 10 & 11 meter bands. **POWER REQUIREMENTS** — Receiver 260-280 v. at .08 amps DC, 14 v. at 3.5 amps. AC.

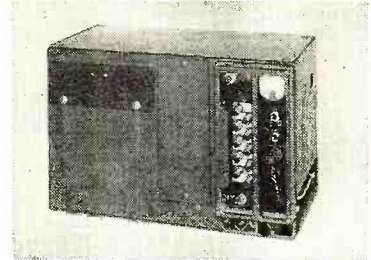

**BC-604 TRANSMITTER**

(alone) **\$19.50**

10 channel, crystal controlled, selected by push button. Xmt. has 7 1619 (2.5v 6L6's) for exciter and FM modulator; 1 1624 (2.5v. 807); final amplified 35 watts; crystal oven for 10 crystals, freq. range 20—27.9 mc. 1 0-100 MA meter measures grid, plate, and ant. current. Price excludes crystals. **POWER REQUIREMENTS** — Transmitter 500 VDC at .22 amps. DC, 14 VAC at 4 amps. AC.

**12 v. Dynamotor for receiver \$9.95**  
**12 v. Dynamotor for Xmt. \$12.50**

1 box of 80 crystals for above, when purchased with trans., \$10.00 per set.

### TRANSFORMERS

for conversion of SCR-274-N  
trans. & Rec. to 115v. AC

#1 POWER XMTR: Pri—115v 60 cycle; sec—500 CT @ .06 amp.; 24v @ 1/2 amp. Your cost only .....\$3.90  
#2 FILAMENT: Pri—115v 60 cycle; Sec. 1—14v @ 7 1/2 amp.; sec. 2—14v @ 7 1/2 amp. Series 28v @ 7 1/2 v.; parallel 14v @ 15 amp. Your cost only .....\$4.50  
#3 FILAMENT: Pri—115v 60 cycle; Sec. 24v. @ 2 amp. Your cost only.....\$2.25

**BE SURE TO WRITE FOR OUR  
BARGAIN BULLETIN**

Name.....  
Address.....  
City.....  
Zone..... State.....

## TUBES! TUBES! TUBES!

BRAND NEW! ORIGINAL CARTONS!

12A6	69c	OD3-/VR150	75c
12SR7	69c	6AK5	79c
12K8	69c	12SA7	69c
12SK7	69c	77	59c
12SF7	69c	78	59c
1625	89c	89	59c
1626	79c	38322	\$1.19
1629	89c	6SN7	89c
12J5-GT	69c	6SL7	89c

### TUBES IN BULK

6SJ7	39c	10-Y	39c
6SJ7	39c	211	49c
6K8	39c		

Write for quantity discount on purchases of 50 or more tubes. MINIMUM TUBE ORDER, \$3.00

## RACKS & MOUNTS

### SCR-274

Dual Trans. Rack FT226 and Mount .....\$2.25  
Triple Receiver Rack FT220 and Mount .....\$2.75  
BC348 Rec. Rack, Mount and Plus .....\$2.00

### WIRE

Hook-up Wire J-ANC-48 per ft.  
# 4 Stranded .....0.095  
#14 Stranded .....0.015  
#16 Stranded .....0.013  
#18 Stranded .....0.01  
#20 Stranded .....0.01  
#16 solid, with insulation .....0.015  
#14 bare copper, 1 lb. spools, per lb. 75c  
52 Ohm Coax Cable  
RG5U and RG8U, \$48.00 per M or \$5.50 per C.

### High Voltage

## FILTER CONDENSER

For Television Set Builders

3000 VDC tested. 3 section 1 mfd ea. Paper and oil dielectric. Separate connectors for pos. or neg. on top of can. Bottom bracket mounts attached. 2 1/2"x 3 1/4"x 4 3/4" mounting space..... **\$4.89**

### We Agree With WARE-MALLORY!

*It's easier to tune the inductance.*

We have a continuously tuning inductance coil, when used in conjunction with a 50 mmfd vacuum condenser, which will tune the entire range from 3500 kc to 30,000 kc. This coil uses a running tap controlled from a knob on the front, a vernier logging dial and isolantite insulation.

- Variable inductance tuner
- 2 ea. 50 mmfd vacuum condensers—series for 10 and 20 meters, parallel for 40 and 80 meters.
- Continuous tuning without changing coils.
- 10 through 80 meters.
- Efficiency plus!
- Reduce trans. bulk.
- Eliminate costly parts.

KIT of 1 inductance tuner and 2 vacuum condensers, ONLY..... **\$4.95**

## BEAM ROTOR & SELSYN INDICATOR

FOR 2 or 6 METER **\$12.95**

both for

Plenty of torque for 2 or 6 meter beam; 360 degree indication with selsyn ind.; slip rings and loop assembly to connect feed line for 360 degree rotation; instructions for wiring and parts list FREE with each set.

LP-21 loop only, \$8.95 1-82 selsyn indicator, \$4.90

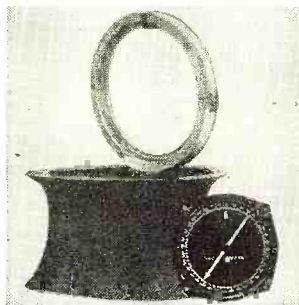

**MOBILE WHIP  
ANTENNA**

(or dipole) **\$2.89**

Solid spring steel; nickel plated; has broad response, antenna matching base. TWO for **\$4.50**

• SAVE C.O.D. CHARGES and speed your order by remitting in full or 25% deposit. Please don't send money for postage; we ship "transportation charges collect". These prices supersede all previous prices.

**ALL EQUIPMENT F.O.B.**

# R & M RADIO COMPANY

1426 N. QUINCY ST. DEPT. RN-98 ARLINGTON, VIRGINIA

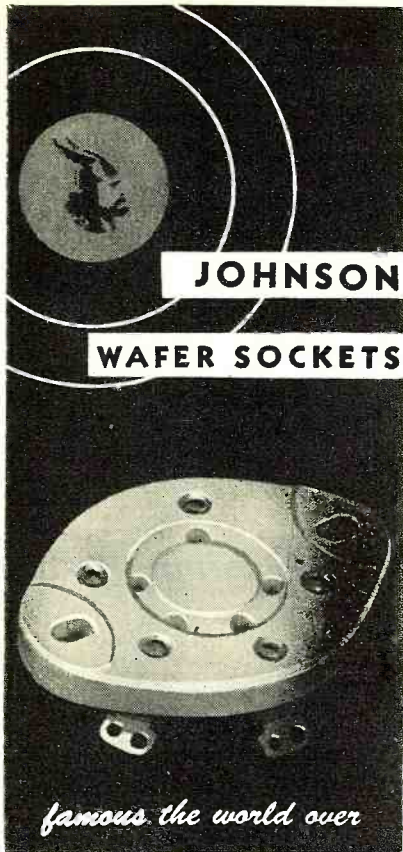

Exactng users prefer JOHNSON wafer sockets because they are insulated with grade L4 steatite or better, top and sides are glazed, the underside is impregnated against moisture. Contacts are brass with steel springs, cadmium plated and are mounted against phenolic washers in molded recesses to prevent movement. Rivets are countersunk and mounting holes bossed to permit sub-panel mounting. Locating grooves facilitate tube insertion.

Illustrated above is the 122-225, a 5 pin socket which can be used with such tubes as the 807.

#### ADDITIONAL TYPES

- 122-224, 4 pin, for tubes such as the 812 or T40
- 122-226, 6 pin for tubes such as the T21
- 122-227, 7 pin medium, for tubes such as the RK34
- 122-217, 7 pin small, for tubes such as the 6A7
- 122-228, octal, for tubes such as the 6L6 and 815

Also available are Giant Wafer Sockets for transmitting tubes, of 5 or 7 pin bases, sockets incorporating a base shield, and Super Jumbo 4 pin base sockets.

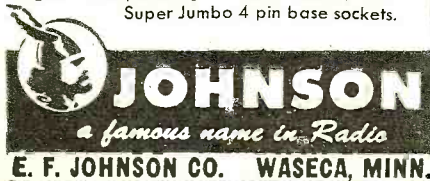

## Color Television

(Continued from page 40)

ducing up to 300 footcandles incident light. The minimum amount of light required was 50 footcandles. Color balance of the system was accomplished by corrective filters. The projection picture has a screen brightness of approximately 20 to 35 foot lamberts which produces acceptable pictures in a partially lighted room.

Along with the live pick-up equipment, slide projector equipment has been developed which projects colored still pictures and slides. No colored motion picture film has been transmitted by this system as yet, but it may be readily accomplished with a suitable television film projector either of the intermittent or the continuous film type.

The upper drawing of Fig. 1 shows the transmission portion of the system, and the lower one shows the receiving portion.

Referring to the upper diagram, the object (10) is picked up by the trichromatic lens and filter system (11) which projects three images (12, 13, and 14), of different color, onto the photoelectric screen (16) of the pick-up tube (17). The images (12, 13, and 14) may be red, green or blue, respectively, the three images being conveniently grouped side by side. An important feature of the system is that the images do not overlap. The area of the screen (16), upon which any particular color image is projected,

continuously receives and responds to images of that same color.

The pick-up tube and transmission equipment may be of the conventional construction employed for black-and-white television, and comprises the cathode-ray tube (17), operated in the usual manner for developing picture signals, and provided with a photo-sensitive mosaic screen (16). The electron beam (20) is projected onto the screen (16) and is caused to scan the screen in the usual manner by means of deflection coils (21 and 22), connected to line and frame deflection generators (23 and 24 respectively). The responses from the photo-sensitive screen are conveyed to the amplifier and radio transmitter (25).

The radio receiver (26), seen in the lower diagram, is connected to the line and frame deflection generators (27 and 28), which are connected to the deflection coils (29 and 30 respectively), which deflect the electron beam (31) of the cathode-ray tube (32), in the usual manner.

The picture signals supplied to the tube produce three pictures, (33, 34, and 35), corresponding to the three images (12, 13 and 14) of the upper diagram. These pictures are black and white but reproduce the detail and intensities of the originals. The superimposing lens system (37) which may be similar to lens (11), upper diagram, but reversed, collects the three pictures, supplies the appropriate color to each by a filter, superimposes the three color images and projects a picture in natural color of the object (10) on the viewing screen (38).

Fig. 1. Operational details for converting black and white television to color.

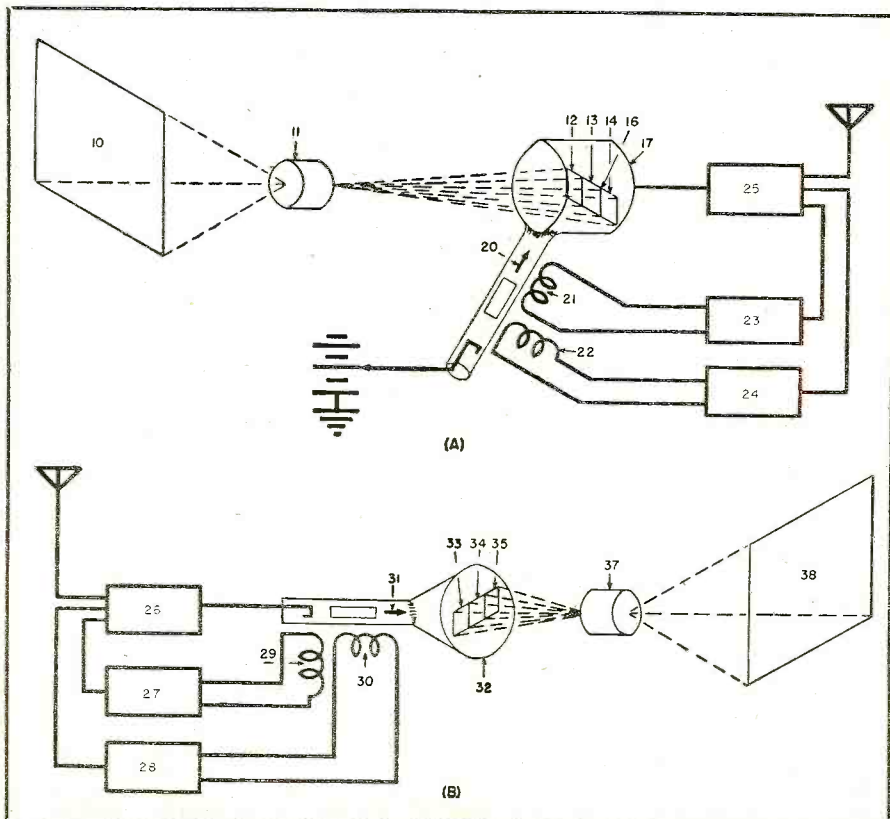

**MONEY BACK GUARANTEE** — We believe units offered for sale by mail order should be sold only on a "Money-Back-If-Not-Satisfied" basis. We carefully check on the design, calibration and value of all items advertised by us and unhesitatingly offer all merchandise subject to a return for credit or refund. You, the customer, are the sole judge as to value of the item or items you have purchased.

**THE NEW MODEL 670**

**SUPER METER**

A Combination VOLT-OHM-MILLIAMMETER plus CAPACITY RESISTANCE, INDUCTANCE and DECIBEL MEASUREMENTS



D.C. VOLTS: 0 to 7.5/15/75/150/750/1500/7500. A.C. VOLTS: 0 to 15/30/150/300/1500/3000 Volts. OUTPUT VOLTS: 0 to 15/30/150/300/1500/3000. D.C. CURRENT: 0 to 1.5/15/150 Ma.; 0 to 1.5 Amps. RESISTANCE: 0 to 500/100,000 ohms, 0 to 10 Megohms. CAPACITY: .001 to .2 Mfd., .1 to 4 Mfd. (Quality test for electrolytics). REACTANCE: 700 to 27,000 Ohms; 13,000 Ohms to 3 Megohms. INDUCTANCE: 1.75 to 70 Henries; 35 to 8,000 Henries. DECIBELS: -10 to +18, +10 to +38, +30 to +58. The model 670 comes housed in a rugged, crackle-finished steel cabinet complete with test leads and operating instructions. Size 5 1/2" x 7 1/2" x 3".

**2840**  
net

**THE NEW MODEL 606**

**TUBE & SET TESTER**

A COMPLETE TUBE TESTER

- Tests all tubes including the new post-war miniature locals such as the 12AT6, 12AU6, 35W4, 50B5, 117Z3, etc.
- Tests by the well-established emission method for tube quality, directly read on the scale of the meter.
- Tests shorts and leakages up to 3 Megohms in all tubes.
- Tests leakages and shorts of any one element against all elements in all tubes.
- Tests both plates in rectifiers.
- Tests individual sections as diodes, triodes, pentodes, etc., in multi-purpose tubes

A COMPLETE MULTI-METER

- 6 D.C. VOLTAGE RANGES: 0 to 7.5/15/75/150/750/1,500 Volts.
- 6 A.C. VOLTAGE RANGES: 0 to 15/30/150/300/1,500/3,000 Volts.
- 4 D.C. CURRENT RANGES: 0 to 1.5/15/150 Ma. 0 to 1.5 Amps.

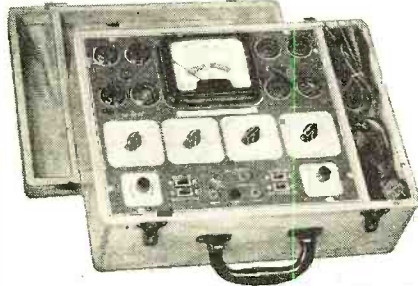

- LOW RESISTANCE RANGE: 0 to 2,000 Ohms (1st division is 1/10th of an ohm).
- 2 MEDIUM RESISTANCE RANGES: 0 to 20,000/200,000 Ohms.
- HIGH RESISTANCE RANGE: 0 to 20 Megohms.
- 3 DECIBEL RANGES: -10 to +38 +10 to +38 +30 to +58 D.B.

Model 606 comes housed in a beautiful hand-rubbed oak cabinet complete with portable cover, test leads, tube charts, and detailed operating instructions.

**4785**  
net

**THE MODEL S-35—A POWERFUL**

**REFLEX PROJECTOR**

COMPLETE WITH BUILT-IN DRIVER UNIT CONSERVATIVELY RATED AT 35 WATTS—HANDLES UP TO 55 WATTS WITHOUT BLASTING. DRIVER UNIT MFG. BY WESTERN ELECTRIC

Heavy gauge aluminum in the main trumpet section completely eliminates blasting and blaring. New plastic diaphragm overcomes the resonant peaks of the old type; also it is absolutely impervious to atmospheric changes whereas the old type was subject to atmospheric corrosion. Complete unit unconditionally guaranteed for one year.



**SPECIFICATIONS:**  
POWER (CONSERVATIVE)—35 WATTS; AIR COLUMN—3 1/2 FT.; DISPERSION—80°; POWER (PEAK)—55 WATTS; BELL DIAMETER—15"; IMPEDANCE—8 ohms; FREQUENCY RANGE—130 to 5000 C.P.S. PROJECTION—1/2 mile; FINISH—Attractive two tone crystalline.

The Model S-35 Comes Complete with Built-in Driver Unit, ONLY

**2850**  
net

**THE NEW MODEL 770—AN ACCURATE POCKET-SIZE VOLT OHM MILLIAMMETER**



(Sensitivity: 1000 ohms per volt) FEATURES:

Compact—measures 3 1/8" x 5 3/8" x 2 1/4". Uses latest design 2% accurate 1 Mil. D'Arsonval type meter. Same zero adjustment holds for both resistance ranges. It is not necessary to readjust when switching from one resistance range to another. This is an important time-saving feature never before included in a V.O.M. in this price range. Housed in round-cornered, molded case. Beautiful black etched panel. Depressed letters filled with permanent white, insures long-life even with constant use. Specifications: 6 A.C. VOLTAGE RANGES: 0-15/30/150/300/1500/3000 volts. 6 D.C. VOLTAGE RANGES: 0-7 1/2/15/75/150/750/1500 volts. 4 D.C. CURRENT RANGES: 0-1 1/2/15/150 Ma., 0-1 1/2 Amps. 2 RESISTANCE RANGES: 0-500 ohms. 0-1 Meg-ohm.

The Model 770 comes complete with self contained batteries, test leads and all operating instructions

**1390**  
net

**THE NEW MODEL 777**

**20,000 OHMS PER VOLT!! TUBE & SET TESTER**

TUBE TESTER SPECIFICATIONS:

- Tests all tubes including New Miniatures, etc. Also Pilot Lights.
- Tests by the well-established emission method for tube quality, directly read on the scale of the meter.
- New type line voltage.

V.O.M. SPECIFICATIONS:

- D.C. VOLTS: (at 20,000 Ohms Per Volt) 0 to 7.5/15/75/150/750/1500 Volts. • A.C. VOLTS: (At 10,000 Ohms Per Volt) 0 to 15/30/150/300/1,500/3,000 Volts. • D.C. CURRENT: 0 to 1.5/15/150 Ma. 0 to 1.5 Amps. • RESISTANCE: 0 to 5,000/50,000/500,000 Ohms, 0 to 50 Megohms. Model 777 operates on 90-120 volts 60 cycles A.C. Housed in beautiful hand-rubbed cabinet. Complete with test leads, tubes, charts and detailed operating instructions. Size 13" x 12 1/2" x 6".

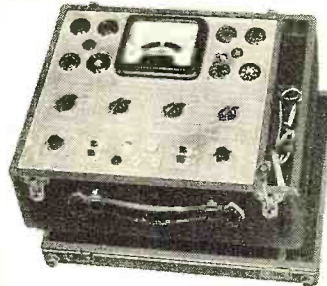

**5995**  
net

**THE MODEL 88—A COMBINATION SIGNAL GENERATOR and SIGNAL TRACER**

SIGNAL GENERATOR SPECIFICATIONS:

- Frequency Range: 150 Kilocycles to 50 Megacycles. • The R.F. Signal Frequency is kept completely constant at all out-put levels. • Modulation is accomplished by Grid-blocking action which is equally effective for alignment of amplitude and frequency modulation as well as for television receivers. • R.F. obtainable separately or modulated by Audio Frequency.

SIGNAL TRACER SPECIFICATIONS:

- Uses the new Sylvania 1N34 Germanium crystal Diode which combined with a resistance-capacity network provides a frequency range of 300 cycles to 50 Megacycles. The Model 88 comes complete with all test leads and operating instructions. ONLY

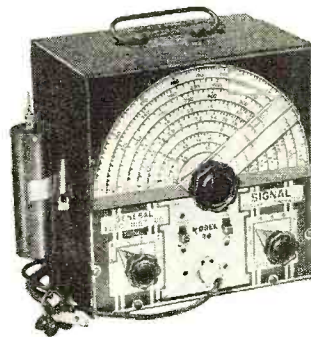

**2885**  
net

20% DEPOSIT REQUIRED ON ALL C.O.D. ORDERS

**GENERAL ELECTRONIC DISTRIBUTING CO.**

Dept. RN9, 98 PARK PLACE  
NEW YORK 7, N. Y.

# Follow the "ARROW" to TOP VALUES!

## T-26/APT-2

Radar jamming transmitter, 450-710 mc. Heising amp.-mod. by noise from 931A photo-tube. Output 3 to 7 watts. All controls on front panel. 2-6AC7 and 1-6AG7 video circuit supply random noise, with pass band of 20 kc. to 4 mc. to the 807 mod. 2-38AS tubes in a push-pull ¼-wave transmission-line osc. circuit supply the RF. Power furnished by 2-5B4GY and 1-2X2 tube. Contains 27vdc blower. Input 27vdc and 75-85v or 105-125v, 400 to 2600 cps. Brand new in original export case, with all tubes and handbook. Don't let this get away from you—Order today! **\$9.95** At only

## T-27/APT-3

Another noise-modulated radar jamming transmitter, companion to the APT-2. 85-135 mc. Power output 9 to 12 watts. M.O.P.A. type transmitter. Built with 4 demountable sub-chassis: R.F. Osc.; R.F. Amp.; photoelectric noise source, video amplifier and modulator; power supply. Tubes are: 1-829B RF Amp., 1-832 RF Osc., 1-931A photo-tube, 2-6AC7 video amp., 1-6AG7 mod., 1-5B4GY rectifier. Brand new, in original export case, with all tubes **\$10.95** and handbook

## MOBILE—VHF—RECEIVER Brand New

Self-contained HF radio receiver and homing equipment used for the reception of a double AM carrier in the freq. range of 2.31 to 258 mc.; operates on 26VDC; includes 10 tubes such as 9001 and 6AK5. A REAL BUY. **\$6.95**

## ALTIMETER TRANSCIEVER RT-7/APN-1

Frequency 418-462 Mc FM, with 14 tubes: 3-12SJ7, 4-12SH7, 2-12BH3, 1-VR150, 2-955, 2-9004; 27 V. Dynamotor, used in working condition **\$7.95**

## RECEIVER-POWER SUPPLY UNIT

For the APN-4 indicator; complete with 16 tubes, 110 V., 400 cycles. **\$10.95** BRAND NEW

## AN18/APT-10

Pre-amplifier Model K-1, designed to raise output level of magnetic type microphone, complete with 2 tubes 6SL7GT and 2SD7 and hand switch, brand new in original cartons.

Each **\$1.95** 3 for **\$5.00**

## C-1 AUTO PILOT AMPLIFIER

The complete amplifier includes one rect. 7Y4, 3-7F7's for amplification and control, 3-7N7's for signal discrimination, 1 power transformer, 6 relays, 4 control pots, chokes, condensers, etc. Convert for use on radio controlled models, doors, etc. Operates from 24 V. DC. Size: 9¼x6¼x7-5/7". Complete. Used—good condition **\$4.95** ONLY

## SELSYN METER TO INDICATE POSITION C-71A/APQ-13

Contains 2" meter, PS-100uA, Weston 506, 0-300 V. 0-30 MA. with 6 precision resistors, as external multipliers and shunts; toggle switches, push switches, rotary switch, pots, knobs, etc. **\$4.95** GOOD CONDITION

## TORQUE AMPLIFIER AM 19/APA-14

Provides amplification of information from Flux Gate Compass to drive torque unit and differential gear of azimuth differential unit CN-4/APA-14. Input 26 VDC and 115 V.; 400 cy. Part of stabilization assembly AN/APA-14. With plugs, 3-6SN7-GT, 2-6H6, transformer, oil-filled condensers, pots, etc. **\$2.95** EXCELLENT CONDITION

## SELSYN INDICATORS

For use with beam rotators for indication of direction of beam. Operate from 15-24V. 60 cycle AC supply. Small model, 3 inch diam. **\$2.45** eter, only

Large model, 5 inch diameter, only. **4.95**

## 400 CYCLE AUTOSYN MOTOR

Ideal for indicating direction of antenna systems—BRAND NEW **\$2.95** each

## COMMAND SET SCR-274 MEDIUM FREQUENCY

Excellent condition **\$29.95**  
Complete installation with 2 transmitters, 3 receivers, racks, tubes, crystals control box and plugs.

## COMMAND RECEIVERS and TRANSMITTERS

(274N Series)—Complete with Tubes **NEW**

T-20/ARC-5 same Freq. BC-457 **\$5.95**

BC-456 MODULATOR. Brand New **2.95**

## REMOTE CONTROL BOX

BC-450—Triple receiver control box, can be modified to a FT-260 local control for command receivers, **NEW \$1.95**

## RADIO RECEIVER

Designed to receive A-N beam signals. 24-28 VDC 21.5 watts. Tube complement: 14H7 or 14AT, RF amplifier; 14H7 or 14T, mixer; 14A7 or 14H7, IF amplifier; 14R7, detector and 1st audio amplifier, 2SD7, output amplifier. 195 to 420 kc. 4" high x 4" wide x 6 7/8" long—wt. 3 lbs., 4 oz. **\$5.95** BRAND NEW in original carton

## ANTENNA THERMO-COUPLE METER

BC-442; 0-10 amps, with extra relay and 50 MAFD 5000 Volt condenser. Used with command transmitters. BRAND NEW. **\$1.95**

## SCR-518-A

Radar altimeter 515 mc. Fast screen CR tube, hi-voltage power supply, connectors, cables, 29 tubes: 1-SK7, 2-3012, 2-6SJ7, 1-6CG3, 1-6SN7GT, 1-6FSG, 1-23D4, 1-6Y6G, 1-6V6GT, 10-6AC7, 3-2X2, 1-954, 1-955, 1-956, 1-6J5, 1-1808P1 cathode ray tube. (With schematics). **\$24.50** Brand new

## SCR-522 CONTROL UNIT

BC-602-B, brand new, export packed, 1 "off" push-button switch, 4 channel-selecting push-button switches, 5 pilot lamp assemblies with pilot bulbs and film dimmer and lever switch with locking control. With Schematic **98c**

## R-5/ARN-7 COMPASS RECEIVER

Very late model ADF receiver. Includes broadcast band. Frequency 100 to 1750 kc. in 4 bands, 5-gang tuning capacitor. With 15 tubes: 4-6K7, 1-6L7, 1-6J5, 2-6B8, 2-6F6, 1-6N7, 1-6SC7, 2-2051, 1-5Z4. SCHEMATIC FURNISHED. Like new, **\$29.95** SPECIAL

## BC-433-G COMPASS RECEIVER

SCR-269-G ADF receiver, similar to the R-5/ARN-7 described above and uses same tubes. Frequency 200-1750 kc in 3 bands. SCHEMATIC FURNISHED. Like new, SPECIAL. **\$24.95**

## RECEIVER-TRANSMITTER BC-620

FM Mobile Transmitter-Receiver operates from 6 volt vibrapack, 20.0 to 27.9 Mc; easily converted to 10-meter freq. 28-29.7 Mc. **\$14.95** New **9.95** Used

OUTPUT TRANSFORMER: 10 assorted ounces for **\$1.89**

## 2-METER TRANSMITTER SCOOP!

The famous AN/ARC-5 VHF Transmitter (T-23/ARC-5), brand new 100-156 mc but less tubes, crystals, and the holders for the 322A tubes. Furnished with complete schematic, 4 Xtal-controlled channels selected by 3 motor-driven turrets. Motor can be spun by hand for manual band switching or driven by low-power rectifier power pack. Tubes required are 2-1625 and 2-822A. Don't pass **\$4.95** this up at ONLY

## ARC 4 TRANSMITTER and RECEIVER

For operation VHF frequencies in range of 140-144 mc. Four channel crystal controlled, manufactured by Western Electric—24V operation. Complete with crystal and dynamotor. Used. **\$19.95** Good condition

## PE-117 UNIVERSAL POWER SUPPLY

6 or 12 volt input; output 145 volts and 90 volts; less vibrator, voltage regulator and rectifier tube; ideal mobile power supply unit; excellent condition, each **\$2.95**

## DYNAMOTORS and INVERTERS

BD-77, Dyn. Unit 14v in, 100v, 350 ma out, with relay fuse box and filters. **\$5.75**  
DM-21 Dynamotor; Part of BC-312 and BC-314, 14v in, 235v, 100 ma out. **\$2.47**  
PE-101-C Dyn. Unit: 12 or 24v in, outputs 800v, 20 ma, 400v, 135 ma, 9v, 1.1A. **\$2.75**  
PE-55Dym. Unit: 12v or 24v in, either 16 or 25 amp, 500r out, either 200 or 400 ma. **\$3.75**  
PE-206 Inverter Unit; rotary converter, 28v in, 80v at 500 VA, 800 cy. out. **\$3.95**  
PE-103 Dynamotor, used **\$6.95**  
DM32A—each, 95c 3 for **\$2.00**

## OUTPUT TRANSFORMER

Hi-Fi; used is Scott-made Navy receiver. Fully potted, Pri. 5000 ohms, output secondary 600 ohms CT, inverse-feedback secondary **\$1.49** 60 ohms CT, ONLY

## GE METER

0-10 amps, DC. **\$2.29** each

## R-89/ARN-5A

Glide path receiver. Crystal control of local oscillator, 332-335 mc, complete with relays, 7-6A75, 1-12SR7, 2-12SN7, 1-28D7, and 3 crystals: 6497 kc, 6222 kc, 6547 kc, 90-cycle band-pass and 150-cycle band-pass filters, excellent for making an intermodulation checker. Beautiful cabinet and chassis as foundation for many interesting experimental and construction projects. Broad pass band on 20.7 mc IP's ideal for television. Schematic furnished. Used, excellent, only. **\$6.45** New **\$12.95**

## BC-733-D

Localizer receiver of the blind landing system. Companion to the glide path receiver. Also contains 90 and 150 cycle band-pass filters, 108.3 to 110.3 mc. by relay selection of crystals in the local oscillator. Wide pass-band on 6.9 mc IP's ideal for FM. Has a wonderful AVC system using rectified output of an RF oscillator as power supply for 100 volt DC bias. With relays, crystals, and 10 tubes: 3-717A, 2-12SR7, 1-12SQ7, 1-12A6, 1-12A7, 1-12SR7. Schematic furnished! **\$3.95** Condition: Used, excellent, only. **\$9.95** New

## VEEDER-ROOT METER AND CASE

Counts up to 1000. **59c** Each

## HAND-TYPE MICROPHONE RS-38

Carbon type, with PL-68 plug, brand new. **\$1.95** Used **1.00**

## BC-645 TRANSMITTER-RECEIVER

BRAND NEW. 15 tubes interrogator-transmitter designed for airborne use. 435 to 500MC frequency range. With some modifications the set can be used for 2-way communication, voice or code, on the following bands: ham band: 420-450mc; fixed and mobile: 450-460mc; citizens radio band: 460-470mc; television experimental: 470-500mc; complete with all tubes, including WB Door-knob tube. Size 10½x13½x4¼". Net **\$9.95** wt. only 25 lbs. Your cost, only

DYNAMOTOR FOR ABOVE Model **\$2.75** PE-101-C

## RADIO PARTS

Assorted Bypass Condensers, 400-600WV **\$4.29** 100 for

100 Resistors ¼ to 1 watt. **95c** Electrolytic condensers

50-30, 150 Volt. **\$2.89** 10 for

½ and 2 Meg. Volume Controls **3.00** 1" shaft with switch, each 39c 10 for

½ Meg. Volume Controls **1.95** 1" shaft without switch, 10 for

Crystal Pick-up. **1.79** new light wt. each

Heavy Duty 12" PM Speaker. **5.95** NEW each

All shipments F.O.B. Chicago or Los Angeles. 20% Deposit required on all orders. Minimum order accepted \$5.00. California and Illinois residents, please add regular state sales tax to your remittance.

# ARROW SALES, INC.

Main Office  
1712-14 South Michigan Avenue  
Chicago 5, Illinois

North Side Branch  
1802 North Humboldt Blvd.  
Chicago

West Coast Branch: 1260 South Alvarado, Los Angeles, Calif.

# Follow the "ARROW" to TOP VALUES!

## BLOWER MOTOR

24V AC or DC, small portable with fan, ideal for defroster or ventilator unit, 17,000 RPM, BRAND NEW **\$1.95**

### THE LAZIEST Q-5'er

FL-8-A, used when flying radio range. RANGE-VOICE-BOTH switch selects 1020 pass ONLY, or voice freq. minus 1020 cps, or by-passes filter completely. Put in series with hi-impedance headset when listening to 1 kc MCW... **\$1.95**  
FL-30 ..... 95c

**AUTOMATIC FREQUENCY CONTROL UNIT**  
Western Electric type used for controlling frequency for teletype and telephone work complete with 3-6S37 and 2-6H6 tubes. Complete unit, brand new in original box... **\$4.95**

**BC-604 FM 35 WATT TRANSMITTER**  
A-1 condition, complete with tubes, 10 channel push buttons, less crystals and power supply, 19.6-27.6 Mc ..... **\$10.95**

**FILTER CHOKES—All Fully Enclosed**  
3.7 H. @ 145 MA. DC., 125 ohms DC. Res. **59c**  
4 MTG. Studs, each ..... **59c**  
100 mi 10H..... **59c**

**APN-1 RADIO ALTIMETER**  
Complete 420 MC transmitter-receiver unit, complete with all plugs, indicators. **\$34.50**  
BRAND NEW

**AN/PRS-1 MINE DETECTOR—BRAND NEW** ..... **\$9.50**

### BC-929-A

Contains power supply 110 V. 400 cycles, has 7 tubes such as 3CP1, brand new, complete with tubes. Each **\$17.95**; Used, ea. **\$14.95**

### R-78/APA-15

Has 45 tubes, one 5" scope tube, one 2" scope tube, has 3 meters, 4 power supply units 110V 400 cycles, complete with tubes. **\$39.50**  
Each

### COMPASS RECEIVER MN-26

Remote control commercial type navigational receiver. Indicates direction of any desired transmitting station. 3 bands—frequency range: 150 Kc to 1500 Kc; has 12-6 V. type tubes. Brand new, original cost \$600. **\$24.95**  
Now

Accessories for Above:  
Loop MN-20 ..... **\$9.25**  
MN-28 Control Box ..... **7.25**  
MN-52 Loop Control Unit ..... **4.45**  
Loop Transmission cable—168" long ..... **9.95**  
MC-124 Flexible Shaft ..... **2.45**  
IN-10 Left-right Indicator ..... **9.95**  
Set of 3 plugs ..... **4.60**  
MN-40 Navigators Indicator ..... **12.95**

### T-17B HAND MIKE

BRAND NEW ..... perfect carbon hand mikes, light wt., 200 ohms single button press to talk switch, 5 ft. rubber cord, plug, dust cover. **89c**  
ONLY

### OIL-FILLED CONDENSERS

.25 MFD at 1500 VDC ..... **59c**  
2 MFD 220 VAC ..... **29c**  
ground piping, etc.  
.25 MFD at 6000V DC ..... **\$1.49**  
.5 MFD at 750V AC ..... **.29**  
2 X .25 at 2000V DC ..... **.29**  
3000 MFD at 3V DC (electrolytic) ..... **.19**

### COAXIAL CABLE BUYS

RG-8/U: 52 ohm coax. cable, brand new, cut to length, min. quant. 100 ft. **\$2.95**

### REMOTE POSITION INDICATING SET

6-12 V. 60 cycles. 5 inch indicator with 0-360° dial. Heavy duty transmitter.  
Indicator ..... each **\$4.95**  
Transmitter ..... each **2.95**  
Set ..... **7.95**  
HS-33 (Red plug), low impedance. Used, almost like new. With rubber cushions  
8000 ohms or 200 ohms ..... **95c**

## BRAND NEW!

## TUBE SPECIALS

## BRAND NEW!

304TL ..... ea. <b>90c—four for \$3.00</b>			
3B24 ..... <b>95c</b>	869B ..... <b>\$19.95</b>	837 ..... <b>\$1.95</b>	9001 ..... <b>\$0.49</b>
3B24W ..... <b>95c</b>	872A ..... <b>1.95</b>	838 ..... <b>2.95</b>	9002 ..... <b>.49</b>
3B26 ..... <b>95c</b>	2C26A ..... <b>.69</b>	839 ..... <b>2.95</b>	9003 ..... <b>.49</b>
6G6G ..... <b>69c</b>	1N5GT ..... <b>.69</b>	5BP4 ..... <b>2.95</b>	9004 ..... <b>.49</b>
6H6GT/G ..... <b>49c</b>	211 ..... <b>.69</b>	5BP1 ..... <b>1.39</b>	9005 ..... <b>.49</b>
6S57 ..... <b>72c</b>	12S7N ..... <b>.49</b>	5FP7 ..... <b>1.39</b>	9006 ..... <b>.49</b>
25L6GT/G ..... <b>49c</b>	12A6 ..... <b>.39</b>	864 ..... <b>.49</b>	7193 ..... <b>.39</b>
28D7 ..... <b>69c</b>	12C8 ..... <b>.49</b>	954 ..... <b>.49</b>	4AP10 ..... <b>1.95</b>
250R ..... <b>\$7.95</b>	12J5 ..... <b>.39</b>	RK34 ..... <b>.39</b>	110 VAC Neon Light ..... <b>.39</b>
705A ..... <b>2.95</b>	12K8 ..... <b>.69</b>	35W4 ..... <b>.39</b>	Amperite 10T1 ..... <b>.39</b>
726A ..... <b>14.95</b>	12K8 ..... <b>.69</b>	1625 ..... <b>.39</b>	
801A ..... <b>95c</b>	12AT6 ..... <b>.49</b>	1629 ..... <b>.39</b>	
5BP4 ..... <b>2.95</b>	832A ..... <b>2.95</b>	2051 ..... <b>.39</b>	
W.E. 700A Magnetron. 680-710 mc, 100 KWpk Pwr. Out. .... <b>\$24.95</b>			

Write for lot prices!

## SPECIALS from WEST COAST BRANCH!

**POWER YOUR RIG FROM AC.**  
RA-34 RECTIFIER. Makes a ground xmtr of BC-101, the 12V version of BC-375-E. Convert BC-375-E to 12V by changing heater link switches and relay connections, power it with RA-34. Input 105-125 or 210-250V, 60cy. Outputs: For plates, 100V filtered dc at 350 ma; for relay and mike, 12V filtered dc at 2.4 A; for heaters, 12V ac at 14.25 A. With **\$59.75** tech. manual. Used, excellent condition.

**POWER FOR MOBILE OR MARINE RADIO**  
PE-237 Vibrator Power Unit. 8, 12, or 24V dc input as selected by switch. Outputs for standby or transmit. Very low power drain on standby. Transmit outputs are 2.15V at 160 ma, 105V at 40 ma, 6.5V at 2A, 6V at 500 ma, and 1.4 V at 450 ma. Starter motor switch on unit, schematic pasted inside cover. New units have spare tubes and vibrator; used units may have them. Shock mounted, sturdy, heavy duty for continuous service. Waterproof gasketing and glands for the generous battery cables provided. **\$19.65**  
New, in original packing, excellent condition. **\$13.95** Used, excellent condition.

**SCR-522-A**  
Transmitter, receiver, rack and case. 100-156 mc. 4-channel, xtal controlled, easily converted for variable tuning. Used, excellent condition. **\$24.95**  
With schematic

**ARB RECEIVER**  
Famous Navy ARB (CRV-16151) receiver. 195-9050 kc. In four bands, 8 tubes, 13 meters, sensitivity complete or MCW, MFC or AVC, Sharp or Broad selectivity. With 28V dynamotor. A NATURAL FOR MARINE USE or for adaptation to AC power supply. Used, **\$19.95**  
excellent condition. Each, **\$19.95**  
Remote control boxes ..... Each **\$2.95**

**SOCKET FOR 5BP1 or 5BP4**  
2Z8681.2 For magnal-based CR tubes. With leads attached. New. Each **\$1.50**

**EE-8 ARMY FIELD TELEPHONE**  
Sturdy, highest quality telephone at less than price of a better-class toy. With ringer. Requires only two flashlight batteries for each phone and two wires between each phone. Excellent condition, used. **\$7.95**  
Each

**BD-71 ARMY TELEPHONE SWITCHBOARD**  
Magnet monocrad, of simplest type, 8 trunks (loops). Each loop has a cord, a jack, a drop, and a 2-way lever key. Has built-in ringer and headset and chest set for operator. Ringing from distant end of a loop operates the drop. Operator's phone is connected to loop by snapping key switch in one direction. Snapping the key in the other direction connects the hand generator to the loop. Establish connection between the two loops by connecting the cord of one to the jack of the other. Ideal for camps, motels, oil-field or fire-ber operation, etc. Condition: used, good. **\$12.95**  
Price is ridiculously low, only **\$12.95**  
Special connection offer: BD-71 and EE-8 field telephones, one for each trunk only **\$59.85**

**BD-72 ARMY TELEPHONE SWITCHBOARD**  
Same as BD-71 described above, except larger: for 12 trunks. Condition used, good **\$19.75**  
Only **\$19.75**  
Special combination offer: BD-72 with 12 EE-8, only **\$89.95**

**SCR-625 MINE DETECTOR**  
Portable, in sturdy suitcase container. Detects metallic objects to a depth of approx. 6 ft. Find outboard motors on the bottom of resort lakes, locate underground piping, etc.  
New, in original packing. **\$39.95**  
Used, excellent condition. **\$29.95**

**DYNAMOTORS AIRCRAFT.** Dynamotor, DS-12, 12V in, 170V, 100 ma out, snaps on back of and plugs into the Command Set receivers of SCR-274-N and AN/ARC-5, BC-453, BC-454, etc., and R-23/ARC-5, etc.  
Each **\$6.95**  
E1C0R TYPE: 14V in, 400V, 200 ma out, w/mtg. rack. Brand new. **\$14.95**  
DM-34, 12V in, 220V, 80 ma out, as used on the tank receivers BC-603 and BC-683. **\$2.95**  
Brand new

**A CATHODE-RAY HORIZAN**  
AN/APN-4 Indicator: Uses 5CP1, Loran, convert to test scope, nanadaptor, etc. Contains extremely accurate 100 kc xtal to time sweeps and marker pipe at 2, 20, and 100 kc. Two parallel horizontal sweeps, obtain time differences between signals, between half-power points on pass-band curves, and numerous other scope uses. Experimenters' delight! Use the counter circuits to try the new system of FM demodulation (July Proc. IRE), or to time camera shutters. 25 tubes. Condition: used, excellent. With **\$39.95** schematic

**PLUGS YOU NEED**  
PL-103 For your BC-348 receiver. Fits all models. **69c ea.**  
PL-59, 60, 61, 62, 64. For BC-375-E or BC-191 ..... **50c ea.**

**ANTENNA MASTS**  
Mast sections used with the famous BC-610. Make as long as you like in multiples of 38 3/4". End up with sections MS-49, 50 and 51 (from the top down). We have a few MS-52, but when we are sold out on MS-52, it doesn't matter, because MS-51 fits into MS-53. Put as many MS-53's together as you please; this is the section that is designed to fit into itself for height increase.  
MP-48 Vehicular-mounting base with ceramic insulation, spring section for flexing, fits MS-53. **\$3.95**  
Each

**10-METER FM**  
BC-923: 27-38.9 mc. with 12V dynamotor. Tank communications, superbet with squelch and BFC, 4-channel band switch. BUILT-IN XTAL-CONTROLLED HETERODYNE-FREQ. METER UNIT with 100-ke check points used to set both receiver and accompanying transmitter to exact frequency. Very easy to tune variably; just turn a knob. Use this receiver as exact freq. monitor or simply as a supersensitive FM receiver. Has built-in speaker, schematic pasted to case. Condition: used, excellent, only **\$12.50**

**HEADSET SPECIAL LOW-IMPEDANCE UNIT R14**  
Convert your low-impedance headset to high-impedance, HS-23 by switching to R14 receiver units. New, per pair ..... **69c**

**A SWEET OSCILLOSCOPE DEAL**  
ASB-7 Radar Indicator Unit: For conversion to test scope or for use as modulation monitor. Has standard test-scope CR tube, H Cont, V Cont, Brill, Foc, Gain, and range selection switch. External power source was used. Tubes: 4-6AC7, 3-6HG, 1-5BP1. Condition: used, excellent. LOOK AT THIS **\$9.95**  
PRICE: ONLY

**RADAR TRANSMITTERS**  
ASB-7 Airborne search unit, 0-70 miles, 515 mc. External power supply was used. Condition: used, excellent. **\$12.95**  
BC-702-A: 175 mc using hollow tuned lines in push-pull circuit. Fan cools the hollow lines, forces air through them. Lengthen lines and you're on 2 meters. Including Weston meter, and at a price which justifies experimenting. **\$9.95**  
Brand new. Only

**PREAMPLIFIER BUY**  
External source of power supplies this compact aluminum case only 3 3/4"x4"x2 1/2", containing dual triode power tube 6F8G, inside the case, not standing out from it, and all brand new, in original **\$1.29** packing, for only

**MICROPHONE BUY**  
T-24: Hand-held mike, carbon, with push-to-talk switch, brand new, far superior to older styles. **79c**  
SPECIAL

**24,000 OHM HEADSET**  
P-16: Has long cord, needs no extension, ends in standard plug PL-55. Very high impedance. **95c**  
Brand new, SPECIAL

**MISCELLANEOUS BARGAINS**  
Condenser, Pyranol 2 MFD, 4000 V. **\$4.95**  
Command Transmitter BC-457, brand new, 4 to 5.3 mc. **\$7.95**  
RA-87: Rectifier, selenium, input 95-125V or 190-250V, 50/60 cy. Output 115V dc, 400 ma and 115V ac, 4.35 A. Used, excellent. **\$14.95**  
CD-307: Extension cord, 6 to 8 feet long, for headsets HS-23, HS-33 etc. PL-55 on one end, JK-46 on other end. Brand new. **69c**  
ANB Receiver: Low-impedance, magnetic type, use as under-pillow speaker. **39c**  
New, each

All shipments F.O.B. Chicago or Los Angeles. 20% Deposit required on all orders. Minimum order accepted \$5.00. California and Illinois residents, please add regular state sales tax to your remittance.

# ARROW SALES, INC.

Main Office  
1712-14 South Michigan Avenue  
Chicago 5, Illinois

North Side Branch  
1802 North Humboldt Blvd.  
Chicago

West Coast Branch: 1260 South Alvarado, Los Angeles, Calif.

## "Super-Modulation"

(Continued from page 44)

rier power can be supplied by the tube *PM* as well as the power for positive modulation. This allows a small reduction in the plate input and output of the power amplifier tube *PA*.

The reduction of plate power input and output of the tube *PA* is effected by a small reduction in r.f. drive during positive modulation as shown at *DP*<sub>2</sub> of Fig. 1. This is the result of a predetermined impedance ratio between voltage divider condensers *C*<sub>m</sub> and *C*<sub>p</sub>.

With the higher efficiency and narrow angle of flow of the plate current pulse at *PL*<sub>2</sub> of tube *PM* operating from base 2, the over-all pulse of the two tubes shows a small nick at *N*<sub>1</sub> and *N*<sub>2</sub> of Fig. 2 at carrier level. This is not important, as the flywheel effect of the output tank serves to correct this.

With completion of the positive modulation one-half cycle and carrier level restored, the negative one-half cycle modulation from carrier level to almost zero and back is the next function. This is effected by reduction of the 3000 volts of normal carrier to zero and back, as shown at *M*<sub>n</sub> in Fig. 1.

The negative modulation is a duplicate in waveform of the positive modulation. This negative modulation

duplicates in waveform the negative one-half cycle of about 85 volts shown at *N*<sub>n</sub> in Fig. 1. The blocking effect of the negative audio is applied at *N*<sub>b</sub>, and provides the reduced input drive power to the power amplifier as shown at *DP*<sub>1</sub>.

This results in a great reduction of the carrier during the negative modulation peak at *M*<sub>n</sub>. During this period, tube *PM* is completely inactive. The negative carrier modulation function is accomplished with only 85 volts of negative audio as compared to about 3000 volts required in plate modulation.

Further inspection of the schematic diagram at Fig. 3 shows the basic circuit to be unusually simple and composed of fewer parts and adjustments than other systems. Of special interest are the fixed capacitance values at the input of both the power amplifier and positive modulator, with only conventional tuning and loading of the output. The r.f. is fed to the power amplifier tube *PA* through the two fixed condensers *C*<sub>m</sub> and *C*<sub>p</sub>, with r.f. injection power for the grid of the positive modulator tube *PM* supplied from the junction between the two condensers. These condensers act as an r.f. voltage divider.

Bias for tube *PA* is taken from the voltage divider *R*<sub>3</sub> and fed through resistor *R*<sub>1</sub> through the r.f. choke to the grid of the tube. Bias for tube *PM* is taken from the top voltage divider resistor *R*<sub>2</sub> with the high tap for phone

and the low tap for c.w., switched by relay *RL*<sub>1</sub> as desired. This is fed to tap 5 on the secondary of the modulation transformer.

*C*<sub>11</sub> and *C*<sub>12</sub> are 2μfd. filter condensers across the high and low voltage bias leads to the tubes *PA* and *PM*.

The secondary of the modulation transformer is tapped and delivers 80 to 90 volts of negative audio through the 2 μfd. coupling condenser *C*<sub>3</sub>. This is the blocking voltage used in negative modulation.

Tap 3 on the modulation transformer delivers 160 to 180 volts of positive audio through the r.f. choke for the triggering action of tube *PM* during positive modulation. The 807, last stage speech tube, is triode connected and fed to the primary of the transformer.

110 to 120 volts of audio is developed across the primary for full modulation. *C*<sub>9</sub> and *C*<sub>10</sub> are screen bypass condensers for the two tubes *PA* and *PM* with the 600 volts for the screens supplied from a fixed and regulated source.

Although both tubes are fed from the common d.c. plate supply of about 3000 volts, the power amplifier tube *PA* is shunt fed through meter *M*<sub>1</sub>, and the r.f. choke to the plate. Condenser *C*<sub>4</sub> is used as a blocking condenser to isolate the d.c. between the two tubes and at the same time transfer power generated by *PA* to the output tank circuit consisting of *L*<sub>1</sub>, *C*<sub>6</sub>, and *C*<sub>7</sub>.

*C*<sub>5</sub> is the r.f. bypass for the cold end

# Jobber Questionnaire Shows ADC Transformers Have User Appeal!

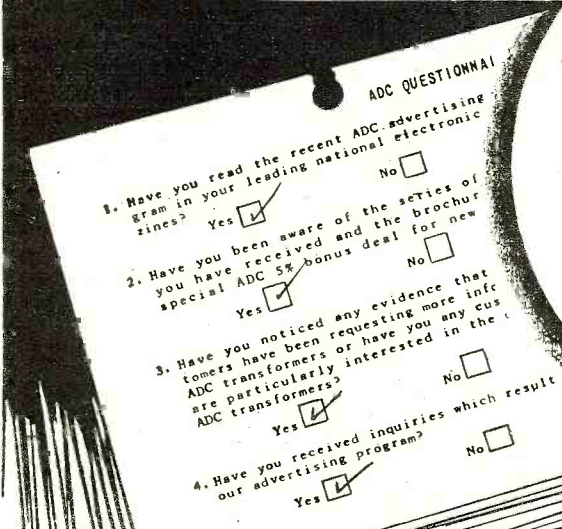

**ADC QUESTIONNAIRE**

1. Have you read the recent ADC advertising program in your leading national electronic zines? Yes  No

2. Have you been aware of the series of ads you have received and the brochure special ADC 5% bonus deal for new customers? Yes  No

3. Have you noticed any evidence that your customers have been requesting more information on ADC transformers or have you any customers particularly interested in the ADC transformers? Yes  No

4. Have you received inquiries which result from our advertising program? Yes  No

Chosen by leading engineers for dependability and quality . . . in research, communications and other electronics.

A recent survey showed that 74% of the nation's top electronic jobbers were reading informative ADC ads in a number of the leading electronic journals. 17½% reported specific customer inquiries and interest shown in ADC Transformers. In less than a year of extensive promotion, ADC quality has penetrated the market and aroused this tremendous interest.

Everyday more jobbers are stocking

the ADC line and are reporting excellent sales results. Some report that the ADC 2nd line transformers out-perform and are more dependable than some 1st line transformers.

Your customers have shown that they want ADC quality Transformers. Give ADC to them for new customer satisfaction and added profit to you!

Send for catalog 46-T today!



## Audio DEVELOPMENT CO

2833 13th AVE. SOUTH · MINNEAPOLIS 7, MINN.

Audio Develops the Finest

Every Month, ADC ads appear in the following national electronic magazines:

- ELECTRONICS
- PROCEEDINGS of I.R.E.
- RADIO NEWS
- AUDIO ENGINEERING
- ELECTRIC. ENGINEERING
- ELECTRIC. EQUIPMENT
- RADIO & ELECTRONIC
- JOBBER NEWS



# LARGEST STOCK OF TUBES IN THE COUNTRY

ALL BRAND NEW — STANDARD BRANDS

MINIMUM ORDER \$5.00  
QUANTITY PRICES ON REQUEST

1B24	4.95	23D4	.49	852	14.95	RK21	3.95	3B7	1.06	6SD7GT	.96	14A4	1.06
1B25A	1.95	45 Spec.		860	3.00	RK22	4.95	3C6/XXB	1.28	6S5	.60	14A5	1.56
1B26	14.95	75TL	3.95	862	49.95	RK25	2.95	3D6	.89	6SF5GT	.72	14A7/12B7	.88
1B27	4.95	100TH	12.95	864	.69	RK33	.98	3E6	1.06	6SG7	.72	14A7/XXD	.88
1B29	4.95	100TS	3.00	865	2.98	RK34	.59	SLF4	1.06	6SGT	.72	14B6	.88
1B32	4.95	102F	4.00	866A	.89	RK59	3.95	3Q4	.72	6SH7	.72	14B7	.88
1B56	8.00	114A	.69	868	1.95	RK60	.75	3Q5GT	.88	6SJ7	.60	14B8	.88
1N21	.59	114B	1.25	869B	75.00	RK65	24.95	3S4	.72	6S7GT	.60	14C5	.88
1N23	2.59	120	5.95	872A	2.50	RK69	49.50	3V4	.72	6SK7	.60	14C7	.88
1P24	11.50	121A	2.65	874	2.49	RK72	1.95	5A24	.42	6SK7GT	.60	14E6	.72
1S21	2.00	203B	10.95	876	.98	RK73	3.95	5R4GY	1.03	6SL7GT	.88	14E7	.88
2AP1	1.95	203R	5.95	878	2.49	RK75	6.25	5T4	1.28	6SN7GT	.80	14F7	.88
2B21	2.95	204A	49.95	879	.89	RX120	10.00	5U4G	.53	6SQ7	.54	14F8	1.06
2B22	5.35	205B	4.50	884	.98	T20	1.95	5V4G	.88	6S7GT	.72	14H7	.88
2C21	.98	211A	3.00	891	.98	T210	2.95	5W4	.88	6SR7	.60	14J7	1.06
2C22	.39	215A	3.00	891	110.00	UX6653	3.95	5W4GT	.60	6SR7GT	.60	14N7	1.06
2C25A	.75	217C	7.50	892R	200.00	V70D	6.95	5X4G	.60	6SS7	.66	14Q7	.88
2C31	.59	221A	2.95	902PI	7.95	VR75	.98	5Y3G	.50	6ST7	.88	14R7	.88
2C40	1.98	222A	120.00	905	11.95	VR78	.75	5Y3GT	.38	6SV7	.88	14S7	1.06
2C43	7.50	227A	3.95	920	2.95	VR90	2.95	5Y4G	.50	6S7G65	.72	14W7	1.06
2C44	1.75	241B	90.95	923	4.95	VR91	1.49	5Z4	.60	6UGT	.72	14X7	1.06
2C46	7.50	242C	5.95	931A	4.95	VR92	.75	5Z4	.88	6U7G	.60	14X4	.88
2D21	1.69	249C	3.49	950	1.06	VR105	.75	6A3	1.06	6V6	.60	19	1.06
2D29	1.39	250R	7.95	953B	4.95	VR150	.98	6A6	.88	6V6GT	.72	19T8	1.06
2E22	1.50	250TH	19.50	954	.75	VT127A	3.00	6A7	.72	6W7G	.88	20	1.56
2E24	4.37	250TL	19.50	955	.75	VU111	1.95	6A8	.72	6X4	.54	22	1.28
2E25	3.95	252A	4.95	956	.75	W460	14.95	6A8G	.72	6X5	.54	24A	.72
2E26	3.79	255A	4.95	957	.75	WL468	14.95	6A8GT	.72	6X5GT	.54	25A6	1.06
2E30	2.25	274A	1.25	958A	.75	WL532A	4.95	6AB5/GN5	.88	6Y6G	.88	25A6G	1.06
2J21A	14.95	274B	1.25	959	.75	WL562	150.00	6AB7/1853	1.06	6Z7G	1.28	25AC5GT	1.06
2J22	24.95	301A	4.95	991	.69	WL616	105.00	6AC5GT	1.06	6ZY5G	.72	25C6G	1.06
2J26	14.95	304TH	7.95	1000	Spec.	WL619	49.50	6AC7/1852	1.06	7A4/XXL	.72	25L6	1.06
2J31	24.95	304TL	1.98	1000T	75.00	Z225	1.95	6AD7G	1.06	7A6	.72	25L6GT	1.06
2J32	24.95	305A	12.95	1611	.89	OA2	1.69	6AG5	.96	7A6	.72	25Y5	1.06
2J34	21.95	307	6.25	1613	.75	OA3/VR75	.98	6AG7	1.06	7A7	.72	25Z5	.54
2J38	37.50	310	4.95	1614	1.75	OA4G	1.06	6AH6	1.42	7A8	.72	25Z6	.72
2J39	34.95	311A	1.98	1616	1.39	OB2	2.05	6AJ5	.99	7AD7	1.06	25Z6GT	.54
2J40	34.95	316A	.89	1619	.75	OB3/VR90	.75	6AK5	.75	7AF7	.26	26	.60
2J42	34.95	322A	120.00	1621	1.98	OB3/VR105	.75	6AK6	.88	7AG7	.27	26	.54
2J49	34.95	327A	4.95	1622	1.75	OD3/VR150	.75	6AL7GT	.72	7AH7	.88	28D7	.88
2J51	34.95	328A	4.95	1624	1.75	OD	.50	6AL7GT	1.06	7B4	.72	30	.72
2J55	4.95	350 A/B	2.95	1625	.49	OY4	.88	6AQ6	.66	7B5	.72	31	.88
2J53	25.00	353A	4.95	1626	.49	OZ4	.88	6AQ7GT	.88	7B6	.72	32	1.06
2J54	25.00	368AS	4.95	1627	7.95	OZ4G	.88	6AR5	.66	7B7	.72	32L7GT	1.28
2K25	24.95	371A	2.95	1628	.69	OIA	.50	6AT6	.54	7B8	.33	33	1.06
2K28	24.95	371B	2.95	1630	7.50	IA3	1.28	6AV6	.54	7C4/1203A	1.06	34	1.06
3AF1	2.95	388A	7.95	1636	5.95	IA4	1.28	6AV6	.54	7C5	.72	35/51	.72
3B22	4.95	393A	7.95	1638	.98	IA4P	1.28	6B4G	1.06	7C6	.72	35A5	.72
3B23	4.95	394A	4.50	1641	.79	IA5GT	.88	6B5	1.56	7C7	.72	35B5	.72
3B24	1.95	417A	24.95	1642	.98	IA6	1.06	6B6G	.72	7E5/1201	1.06	35L6GT	.60
3B25	.98	434A	3.95	1654	1.98	IA7GT	.72	6B7	1.06	7E6	.72	35W4	.46
8B26	5.95	446A	1.95	1665	.98	IA85	1.06	6B8	1.06	7F7	.88	35Y	.72
3BP1	2.95	451TH	1.95	1685	1.95	IB3GT	1.56	6B8G	1.06	7F8	.88	35Z3	.72
3C21	5.95	503	195.00	1852	1.06	IB4	1.28	6BA6	.66	7F8	1.06	35Z4GT	.72
3C22	39.50	527	12.95	1853	1.06	IB5/25S	1.06	6BE6	.66	7G7/1232	1.06	35Z6GT	.46
3C23	4.95	531	49.50	1963	.95	IB7GT	1.06	6BG6G	1.92	7A7	.88	35Z6G	.88
3C24	.69	575A	14.95	2050	.98	IC5GT	.72	6GH6	.93	7J7	1.06	36	.88
3C30	1.50	632A	9.95	2051	.98	IC6	1.06	6HJ6	.60	7L7	1.06	37	.88
3CP1	3.00	701A	3.95	2140	20.00	IC7G	1.06	6C4	.72	7M7	.88	38	.72
3EP1	3.95	703A	4.95	5514	4.95	ID5G	1.28	6C5GT	.60	7N7	.88	39/44	.59
3Q21A	3.00	704A	1.98	5562	10.00	ID5GP	1.28	6C6	.72	7R7	.72	41	.60
3E29	4.95	705A	2.95	7193	.39	IO7G	1.06	6C8G	1.06	7S7	1.06	43	.60
3GP1	4.95	706BY	24.95	8005	4.95	ID8GT	1.28	6D6	1.06	7T7	1.06	45	.60
4-65A	14.30	706CY	24.95	8011	2.95	IE5GT	1.56	6D6G	1.06	7W7	1.06	45Z5GT	.60
4-125A	27.50	707A/B	24.95	8012	4.95	IE7GT	1.56	6E5	.72	7X7/XXFM	1.06	46	.88
4-250A	37.50	708A	7.95	8013	2.95	IF4	.88	6F5	.60	7Y4	.72	47	.88
4A1	1.98	709A	9.95	8016	1.89	IF5G	.88	6F5GT	.60	7Z4	.72	49	.88
4AP10	6.95	713A	1.65	8020	3.95	IF6	1.28	6F6	.72	10	1.56	50	1.56
4B24	4.95	714AY	14.95	8025	7.95	IF7G	1.28	6F6G	.60	12A6	.60	50A5	.88
4C35	19.95	715A/B	19.95	C5B	12.95	IG4GT	.88	6F6GT	1.06	12A6GT	1.06	50B5	.72
4E27	7.95	720A	24.95	C6A	9.95	IG6GT	.88	6F7	1.06	12A7	1.06	50C6G	1.06
4I28	34.95	717A	1.65	C7J	12.95	IH4G	.72	6F8G	1.06	12A8GT	.88	50D6GT	.60
4I29	34.95	720CY	34.95	CQ27	1.95	IH5GT	.60	6G6G	.88	12AH7GT	.88	50X6	.88
5AP1	4.95	721A/B	4.35	CK1005	.39	IH6G	1.06	6H6	.60	12AL5	.72	50Y6GT	.60
5AP4	5.95	723AB	5.95	CK1006	.69	IH6GT	1.06	6HG6T	.60	12AT6	.54	53	.88
5BP1	1.95	724A/B	4.95	EF50	.79	IJ6GT	1.06	6J5	.60	12AT7	.72	55	.88
5BP4	4.95	725A	24.95	EL3C	4.95	IL4	.72	6JGT	.54	12AU6	.60	55	.88
5CP1	3.95	726A	23.50	EL225	1.95	IL4A	1.06	6J6	1.06	12AU7	.88	57	.72
5CP7	13.95	728A	2.25	FI23A	12.95	IL4G	1.06	6J7	.72	12AW6	.96	58	.72
5D21	29.95	801A	.98	FI27A	22.50	ILB4	1.06	6J7GT	.72	12BA6	.66	59	1.06
5FP7	3.95	802	2.95	F660	150.00	ILC5	1.06	6J7G	.72	12BA6G	.66	70L7GT	1.42
5GP1	9.95	803	8.95	FG17	3.25	ILD6	1.06	6J8G	.88	12CB	.88	71A	.72
5JP1	11.95	804	5.95	FG81A	6.95	ILD5	1.06	6K5G	.88	12CH	.60	75	1.28
5J29	5.95	805	4.95	FG105	19.95	IE3	1.06	6K6GT	.54	12H6	.60	76	.60
5J30	29.50	806	17.50	FG172A	32.50	ILG5	1.06	6K7	.60	12J5GT	.54	77	.60
5LP1	11.95	807	1.25	FG238B	160.00	ILH4	1.06	6K7G	.60	12J7G	.72	78	.60
5TP4	20.00	808	2.95	GL146	11.00	ILN5	1.06	6K7GT	.60	12J7GT	.72	79	.88
6AF6G	.88	809	2.50	GL605	250.00	IN5GT	.72	6K8	.88	12K7G	.72	80	.42
6C21	24.95	810	7.95	GL697	150.00	IP5GT	.88	6K8G	1.06	12K7GT	.72	80	.88
6D4	1.95	811	2.25	H F100	3.95	IR4	1.06	6K8GT	.88	12K8	.88	82	.88
6I4	3.95	812	2.95	HF200	17.95	IR5	.88	6L5G	.88	12K8GT	.88	83	.88
6Q5G	1.25	812H	6.90	HY24	1.50	IR5	.72	6L6	1.28	12Q7GT	.60	83V	1.06
7BP7	4.95	813	7.95	HY31Z	5.50	IS4	.88	6L6G	1.06	12SA7	.60	84/6Z4	.60
7EP4	17.95	814	4.95	HY69	2.49	IS5	.66	6L6GA	1.06	12SA7GT	.60	85	.72
7GP4	19.40	815	2.50	HY75	1.25	IT4	.72	6L7	.88	12SC7	.72	89	.72
9GP7	15.00	816	1.19	HY114B	1.25	ITSGT	.88	6L7G	1.06	12SF5	.60	98V	1.28
9JP1	3.95	822	11.95	HY115	1.25	IU5	.72	6NG6	1.28	12SF5GT	.60	98X	1.28
9JP2	3.95	826	.79	HY615	1.25	IU5	.66	6N7	.88	12SF7	.72	117L7GT	1.42
9LP7	4.95	827R	99.50	HYE1148	.48	IV	.72	6N7GT	.88	12SF7GT	.88	117M7GT	1.42

# Radionic's Value Packed Free Catalog

# of RADIO AND TELEVISION PARTS & EQUIPMENT

## EVERYTHING IN TELEVISION

for the  
• SERVICEMAN  
• BUILDER  
• SET OWNER

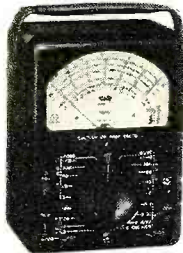

**TRIPLET MODEL 630 V-O-M**  
A completely new V-O-M. Beautifully streamlined... 5 1/2" meter... One switch for all ranges and functions... Molded selector switch body with completely enclosed contacts... Precision resistors for permanent accuracy... 6 ranges to 6000 volts at 20,000 o/p/v. DC... 6 ranges to 6000 volts at 5000 o/p/v. AC... 6 current ranges for 0-60 uA to 0-12 amps... 2 resistance ranges to 100 megohms... Decibel and output ranges... **\$37.50**  
Leather Carrying Case... **\$5.75**

### CRYSTAL DEVICES \$5.88

Interference Trap  
**VEE-D-X LIGHTNING ARRESTER** for TV and FM Antennas. Low loss, non-absorptive—mounts outdoors **\$1.50**

**CERAMICON** fixed condensers: 3, 5, 10, 50, 100, 200, 500 mmf. In lots of 10 **\$0.41/2** assorted each

**CERAMICON** variable trimmers: 3 to 13, 5 to 20, 4 to 30, 7 to 45 each **\$1.18** 6 for **1.00**

**KIVER'S "Television & FM Receiver Servicing"** **\$2.95**  
**KIVER'S "Television Simplified"** **5.88**

**KIVER'S "FM Simplified"** **5.88**  
**TRANSVISION'S 7" Construction Manual** **1.50**

**AEROVOX** tubular condensers, 3500 w.v.  
.001 ..... **\$ .59**  
.005 ..... **.62**  
.01 ..... **.65**  
.03 ..... **.71**  
10,000 w.v. .001... **.68**

**CARBON RESISTORS**, your selection of standard sizes. 1/2 watt, 25 for \$6.00, 100 for \$1.75; 1 watt, 25 for \$7.00, 100 for \$2.00; 2 watt, 25 for \$1.15, 100 for \$3.25.

**SYLVANIA 10HP4** (Electrostatic) **\$51.75**

**SYLVANIA 10BP4** (Electromagnetic) **32.50**

**SYLVANIA 7EP4** (Electromagnetic) **19.40**

**AMPHENOL 59-417** **\$9.99**  
Socket for 10HP4

**CAMBURN MODEL T-34**. Folded Dipole and Reflector for 41-216 mc. Complete with hardware **\$9.70** and instructions

**NEW VERTROD HIGH FREQUENCY ARRAY** to mount on existing TV low frequency antenna. All models include mounting means and hardware.

**HF High Frequency Array only \$3.57**

**HF/D** As above, but including patented Dividing Network **6.51**

**HF/R** High Frequency Array plus reflector **4.71**

**HF/RD** As above but including Dividing Network **7.65**



**NEW AMPHENOL TELEVISION ARRAY (#114-005)** Brighter pictures—fewer ghosts. All 13 channels. Include 75 ft. of 300 ohm line, stand-off insulators **\$16.50** and all hardware

**INDOOR FLEXIBLE TV ANTENNA \$1.03**

**INDOOR FLEXIBLE FM ANTENNA .88**

**AMPHENOL 300 ohm twin lead, per 100 ft. \$2.75**

**AMPHENOL polystyrene twin lead insulators .10 for .90**

**AMPHENOL screw eyes for twin lead .10 for .90**

**72 ohm coaxial cable (\$3.06 per ft.) 100 ft for 5.40**

**AMPHENOL Screweyes for coaxial cable .10 for .90**

## All RCA and TRANSVISION parts in stock

MAIL TODAY FOR YOUR  
**FREE CATALOG**

# RADIONIC

**EQUIPMENT COMPANY**

DEPT. 59  
TRIBUNE THEATRE ENTRANCE  
170 NASSAU ST., N. Y. 7, N. Y.  
CABLE "CHANSFOR"  
Worth 20421

Radionic Equipment Co., Dept. 59  
170 Nassau Street, New York 7, N. Y.

Send at once your free catalogs, supplements and Bargain lists as published—listing products of leading manufacturers of radio-electronic parts and equipment.

NAME .....

P.O. BOX or STREET .....

TOWN ..... STATE .....

## RADIO-TELEVISION

Learn the practical way—in laboratories equipped with commercial equipment. Acquire the practical "on-the-job" skills essential for a successful technical career. Prepare now for the high income opportunities open to specialists in Radio Communications (FCC licenses) and in Radio-Television Servicing. Before enrolling anywhere, investigate the advantages of WRCI Specialized Training—the training "with-a-purpose". Send today for Bulletin "L"—no obligation. Approved for veterans; non-veterans accepted.

**WESTERN RADIO COMMUNICATIONS INSTITUTE**

"Specialists in Radio-Television Training"

341 West Eighteenth Street Los Angeles 15, Calif.

## WANT TO TRIPLE YOUR EARNINGS ON RADIO REPAIR WIRING?

Get the AMP Radio Repair Kit and see for yourself how it makes **SOLDERLESS** connections **QUICK AS A WINK!**

**One Tool** does all the work—cuts and strips wire and attaches terminal to wire with a squeeze of the hand—tool has insulated handles and is of quality tool steel with corrosion resistant finish—

**100 assorted electronic terminals** including quick disconnect splices, and supply of tubing for insulation—

**Complete Kit**—only \$5.95—pays for itself in a few hours—works for you all through the year. Replacement terminals available at low cost.

**MODEL BUILDER'S KIT ALSO AVAILABLE**—only \$5.95

Send cash, check or money order to  
**RICHARD RENNER ASSOCIATES**  
315 S. 15th Street Dept. RN Philadelphia 2, Pa.

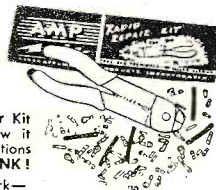

of the tank coil. Plate voltage for tube  $PM$  is fed through meter  $M_2$  and the r.f. choke through the tank inductor to the plate of  $PM$ . The plate of  $PM$  is tapped about mid-point on the tank coil so that tank condenser  $C_7$  may be charged separately as required.

The voltage developed by this condenser will discharge at this point of the coil, and will be stepped up by the autotransformer action of the complete coil. Operation of tube  $PM$  and its associated components provides at least double the current and voltage of carrier level, as required for positive modulation.

The inductor  $L_2$  is coupled to the tank inductor  $L_1$  for the power transfer to the load or antenna as desired, with condenser  $C_8$  for matching of the load, and meter  $M_3$  measuring the antenna current.

Also shown is the 6L6 electronic keying tube and associated components, with switch  $S_1$  as the phone-c.w. changeover switch. Bias blocking voltage for the keying tube is fed from the voltage divider  $R_3$ . Change of the phone-c.w. switch to the c.w. position allows several functions at the same time.

The keying circuit to the doubler cathode is opened, the grid of the 807 audio tube is grounded, and the bias of the positive modulator tube is reduced so that it may act as a booster for the power amplifier tube  $PA$  for increased output in telegraph service. When a conventional telephone transmitter is used for c.w. the modulator tubes are of no use.

Adjustment procedure is somewhat different than with other systems inasmuch as it is simpler. The power amplifier tube has screen voltage of a fixed value, limiting the dissipation, either in or out of adjustment. The r.f. drive is in the neighborhood of that required for telegraph service, at a lower value than that required for plate modulation.

The power amplifier tube actually has its plate input lowered during the positive modulation, permitting far less r.f. drive power with greater stability and less strain on the tubes during all functions.

A plate modulated tube takes an increased input during positive modulation, whereas the power amplifier tube in the Taylor system is allowed a pulsed cooling period under positive modulation. As the tube is operated at telegraph ratings, it has a cooling period similar to that of the key up conditions in telegraph service.

The positive modulator tube is not subjected to continuous use as it operates only on pulses. Its power is delivered directly to and on the carrier without the troublesome impedance matching modulation transformer.

The r.f. drive and last stage speech tube requirements are conventional. However, reserve power delivery capacity should be provided as the modulated output of the system requires full positive peaks of voltage from

**RADIO & TELEVISION NEWS**

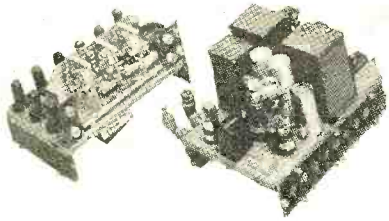

### BC-800A RADAR TRANSMITTER & RECEIVER

Loaded with tubes and components for the VHF experimenter. Contains 19 tubes including 1-955, 3-956's, 1-2C26, 1-5U4G, 1-2X2, 1-6SN7, 7-6AC7's, 2-6SL7GT's, 1-6V6GT, and 1-6H6GT/G. Several HF tuned circuits, 7 amphenol chassis fittings, sockets, 24 V. blower and motor (will operate on 110 V. AC), 2-4Mfd. 600 V. condensers, and many other resistors and parts. Weight approx. 40 lbs. In metal case 12 1/2" x 11 1/2" H x 8" D. **\$14.95**



A—Resistor kit composed of 150 or more assorted wattages. Containing various resistors of up to 10 megohms. Many with gold bands. An honest-to-goodness bargain. **Box \$2.65**

B—Condenser Kit. Contains assortment of 25 various condensers including 2-EMfd. 600 V. filters, 1-1000 Mfd. 15 V. filter, 4-1 Mid. 400 V. paper by-pass, 3-3 gang midjet trimmers, etc. **\$2.65**

C—Hardware Kit containing about 5 lbs. of radio hardware including nuts, bolts, washers, shafts, gears, grommets, lugs, screws, spacers. It is a gold-mine of invaluable parts. **\$1.95**

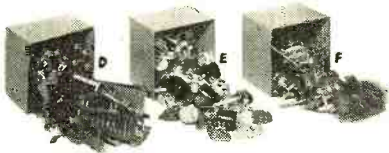

D—Resistor mounting lugs and terminal strip kit. Assorted sizes and shapes. Many, Many. **\$1.00**

E—Tube Socket Kit. 25 or more assorted sockets having various usable sizes. **\$1.50**

F—Switch Kit consisting of assortment of 10 rotary and toggle switches. Price. **\$1.25**

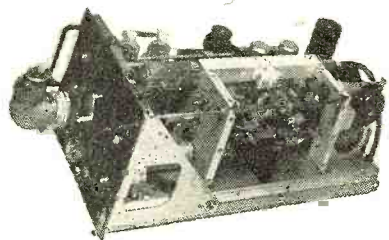

### T-39/APQ-9 RADAR TRANSMITTER

Loaded with VHF parts and tubes such as 2-RCA 8012's, 1-931A, 2-807's, 1-6AG7, 2-6AC7's. The RCA 8012's are rated at 50 W. input to 500 Mc. Contains variable parallel-plate oscillator silver plated, ventilating blower and motor, ceramic tap switch, pots, terminal strips, gears, counters, etc. Weight 36 lbs. Size 22" L x 10 1/2" W x 7 3/4" H. **Price \$9.75**

ALL PRICES F.O.B. INDIANAPOLIS  
**Telephone LINCOLN 8328**

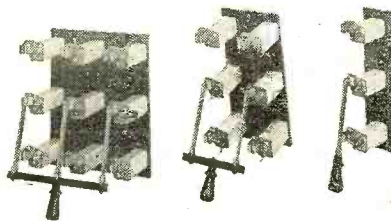

### ANTENNA KNIFE SWITCH

Has 2 1/2" porcelain insulator bakelite base, heavy blades 4" long.

- Single Pole Double Throw ..... **\$ .75**
- Double Pole Double Throw ..... **\$1.00**
- Triple Pole Double Throw ..... **\$1.25**



### TELRAD 18-A FREQUENCY STANDARD

Checks signals in the range of 100 Kc. to 45 Mc. with a high degree of accuracy. Self-contained power supply is 110, 130, 150, 220, and 250 V. 25-60 cycle AC. Complete with tubes, dual crystal, and instruction book. Brand new. Price. **\$24.95**

**\$24.95**

### CO-AXIAL CABLE VALUES

CO-AXIAL CABLE VALUES THAT WE CAN ONLY OFFER TO CUSTOMERS WHO BUY MINIMUM OF 100 FOOT PER TYPE.

- RG-8/U Cable 52 ohms impedance (unmarked) ..... **\$2.95** per 100 ft.
- RG-8/U cable 52 ohms impedance (marked) ..... **\$3.95** per 100 ft.
- RG-29/UCO AXIAL 53.5 ohms imp. (marked) ..... **\$3.95** per 100 ft.

### Westinghouse MERCURY-VAPOR

Battery charger bulbs. Commercial 6A. Style 289416, for screw socket. For 6 or 7 batteries charged at one time—2000 to 3000 hours with special high resisting glass. **NEW \$3.95**

TERMS: CASH WITH ORDER

## AMERICAN SURPLUS PRODUCTS CO.

537 N. CAPITOL AVE.  
INDIANAPOLIS, IND.



### BRAND NEW SCR-625 MINE DETECTOR

Attention, Prospectors, Miners, Oil Companies, Plumbers, etc.

Used by the Army to detect buried metallic mines. Its private use suggests the location of underground or underwater pipes, cables and ore-bearing rock, the location of metallic fragments in scrap materials, logs, etc., and the screening of personnel in plants for carrying of metallic objects. New, complete in original overseas packing container. Originally sold by War Assets for \$166.00. The U. S. Forestry Service has recommended procedure for using the SCR-625 Mine Detector to find concealed metal in tree logs and other timber products.

BRAND NEW

Price **\$79.50**

Used but checked and O.K.

**\$49.50**

Shipping Weight 125 lbs.

Size: 8 1/4" x 28 1/4" x 16"

Batteries not furnished—we can supply for \$4.50 extra.

### BLASTING MACHINES

Originally manufactured for the U.S. Army by White-Rodgers Electric Company. Detonate electric blasting caps. 10 cap capacity. BRAND NEW CONDITION.

Price ..... **\$4.50** each

# United's SUPER VALUES!!!

## MITEY-MITE

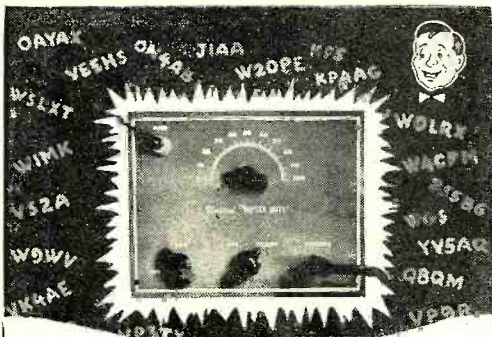

**It's Tiny! It's Thrilling! It's Terrific!**

A complete Transmitter and Receiver Kit for 75-80 meter C.W., incorporating these features:—3 latest multipurpose tubes—Crystal controlled transmitter—Improved regenerative receiver—Built-in AC-DC 110 V. power supply—Plug-in coil for receiver frequency change—Single control operates transmitter or receiver—Same antenna for transmitting or receiving. The "Mitey Mite" is ideal as a beginner's project or as an auxiliary rig for the old timer. Tests have shown remarkably gratifying results. Get on the air with the "Mitey Mite," while rebuilding the main rig! Tube line-up: 12 BA6 Def., 50B5 Xtal Osc.—Audio Amp. 35W4 Rect.

**Immediate Delivery**  
**ORDER NOW! 25% DEP. BAL. C. O. D.**  
**Complete Mitey Mite Kit \$14.95**  
 (less key and headset)

- Fenwal Thermoswitch. Cartridge Type.  $\frac{5}{8}$ " dia.  $3\frac{1}{2}$ " lg. Variable adj. and lock. Two 8" leads. Set for 200-210. 115 V. @ 10 Amps. 230 V. @ 5 Amps. New. Each.....**98c**
- Westinghouse Cartridge Heater. 115 V. 100 Watts.  $\frac{1}{2}$ " dia.  $2\frac{3}{4}$ " lg. Has 2 heat resistant leads  $10\frac{1}{2}$ " lg. Temp. to 750 F. New. Only.....**98c**
- Klixon Time Delay Relay. 115 V. @ 30 Amps. load. 115 V. element draws 7 W. 30 sec. delay. New. Each.....**59c**
- Beam Elements! Aluminum seamless tubing,  $\frac{3}{8}$ " OD. by  $\frac{3}{64}$ " wall. (Shipped Express only.)  
 10 ft. lg. Each.....**98c**  
 12 ft. lg. Each.....**\$1.39**
- Miniature Relay—24 V. S.P.D. T.Type P3 and 405. 1280 ohms.  $1\frac{1}{2}$ " x  $1\frac{1}{2}$ " overall. New.....**29c**
- 5 Gang Potentiometer (Clarostat). 4" long.  $1\frac{7}{8}$ " dia. insulated. 6000 ohms, 2500 ohms, 2 x 30,000 ohms. New. Each.....**69c**
- Relay Rack Panels. .051 aluminum. Hard.  $19\frac{1}{2}$ " x  $10\frac{1}{2}$ " (Unfinished). Standard notching. Each.....**69c**

- Quantities are limited—Order now! Prices subject to change without notice.
- Minimum order—\$2.00; 25% Deposit Required. Balance C.O.D. All orders shipped f.o.b. Chicago. All Foreign Shipments, minimum order—\$50.00.

★ Write for free copy of UNITED SURPLUS new Flyer!

## UNITED SURPLUS MATERIALS

3313-19 W. OGDEN AVE.

CHICAGO 23, ILL.

### SPECIALS

- 0-500 D.C. Voltmeter 3" Round (1000 O/P/V). New.....**\$2.79**
- 6 Mfd. 1000 V.DC Size:  $1\frac{1}{4}$ " x  $3\frac{3}{4}$ " x  $5\frac{1}{8}$ ". Oil filled. Each.....**\$1.29**
- 4 Mfd. 800 V.DCW Sealed Cond. New. Each.....**59c**
- 4 Mfd. 3000 V.DC Oil filled. Size:  $3\frac{1}{2}$ " x  $4\frac{1}{2}$ " x 5". New. Each.....**\$4.79**
- 3 Mfd. 2500 V.DC Oil filled. Size:  $3\frac{3}{8}$ " x  $4\frac{3}{8}$ " x  $5\frac{7}{8}$ ". New. Each.....**\$3.69**
- 2 x 3 Mfd. 2500 V.DC Oil filled. Size:  $3\frac{7}{8}$ " x  $4\frac{3}{8}$ " x 9". New. Each.....**\$6.95**
- 8 Mfd. 2500 V.DC Oil filled. Size:  $3\frac{7}{8}$ " x  $4\frac{3}{8}$ " x 9". New. Each.....**\$8.95**
- 2 Mfd. 5000 V.DC Oil filled. Size:  $4\frac{7}{8}$ " x  $4\frac{1}{2}$ " x 8". New. Each.....**\$9.95**
- 800 Mfd. 50 V.DCW Non-Polarized. Size 3" dia. x  $3\frac{3}{8}$ " H. 4 prong mounting. New. Each.....**59c**
- 1000 Mfd. 8 V.DCW Cardboard cartridge type. New. Each.....**49c**
- 807 Ceramic socket with below chassis mounting flange. New. Each.....**19c**
- National 5 prong socket. Isolantite. Centers,  $1\frac{1}{8}$ " New. Each.....**12c**
- Mica condensers, .0005 @ 3000 V.DCW. New. Each.....**87c**

- Dummy Antenna Resistor (Ohmite).  
 100 W. 600 ohms. New. Each.....**98c**  
 100 W. 219 ohms. New. Each.....**98c**  
 250 W. 73 ohms. New. Each...**\$1.39**  
 250 W. 104 ohms. New. Each...**\$1.39**

- Toggle Switches. Bat-handle S.P.S.T. Standard S.P.S.T. Each.....**25c**
- Selenium Rectifiers. Dual, input: 7.1 V.A.C. 115 Cyc. Output 1.7 W @ 2-4 Amps D.C. Ideal for converting battery sets to A.C. Each.....**49c**

- Remote Control Cables. Used with compass units, MN-26, BC-433G, RA-10, etc. 20' long. Has spline couplings on both ends. New.....**\$2.39**

- Loom. Weather-proof. Heavy fabric. Ideal for sleeving on TV. or FM. lead-ins, through skylights or around corners. Inside dia:  $\frac{1}{4}$ ",  $\frac{1}{2}$ ",  $\frac{3}{8}$ " (specify size). Minimum order 50'. Any size. 50 Feet.....**\$1.45**

- New Modified Electronics Surplus Package! 10 lbs. of assorted electronic units and parts, worth many times our low price of only.....**\$1.49**

both the r.f. drive source and the audio output tube.

Complete and ready for operation, including all power supplies, speech and modulation equipment, the 900-A unit is easily portable.

The 1 kw. transmitter section of the console, complete on a single main frame sub-assembly chassis, contains the complete r.f. chain consisting of a 6V6 oscillator, 6V6 doubler, TB-35 buffer-amplifier and the 4-250A power amplifier.

All controls of these stages are front panel operated. A 6L6 keying tube is mounted under the chassis and is front panel controlled for phone-c.w. operation.

The second 4-250A, as positive modulator and c.w. booster, is located on the power amplifier tube deck in the center of the chassis. The 807 last speech tube, modulation transformer, and 6SJ7 speech amplifier tube are located at the left rear of chassis.

Four sub-panel mounted meters are provided, with two of 0-500 ma. range, for reading the plate current of the power amplifier and positive modulator. The third meter of 0-10 volts range, meters the filament of the power amplifier, and the fourth meter, a 0-100 ma. type, is front panel switched for measurement of the plate current of all other r.f. stages and the 807 audio stage.

Unusual ease and simplicity of tuning is allowed, as the four front panel controls tune only the plate circuits of the r.f. stages. This eliminates any adjustment or tuning of the grid circuits. The only variable coupling circuit in the unit is that of the output link for the transmission line or antenna.

All r.f. stages are highly biased so that in tuning an out-of-resonance condition of any of the r.f. exciter stages causes no damage to any of the tubes in the following stages. The positive modulator is not affected by tuning, as it draws very little plate current with no modulation.

Plate current off resonance is not excessive as the high bias and the fixed screen voltage on this tube allows only a slight increase in plate current in the out of resonance condition.

By providing high fixed bias on all stages, and limiting screen and plate voltages, we have a pretty safe transmitter, that under a momentarily detuned condition, operates without damage to tubes or equipment.

The plate tank coils of all the r.f. stages are of the plug-in type, with band change requiring about 30 seconds. This type of band change was selected after deciding that maximum efficiency and stability at the high frequencies was more important than the convenience of bandswitching.

No neutralization is required, and no suppressors are required in either grid or plate leads in any of the tubes.

The power supplies are of conventional design. A 5Z3 tube is used as a

**WANTED**—Western Electric Carrier Telephone and Telegraph Equipment and Components. Filters, repeating coils, transformers, equalizers. Types CF1, CF2, H, C, and other carrier equipment. Telephone and telegraph repeaters.

Box 450, Radio News, 185 N. Wabash Chicago, Illinois

## LEARN TELEVISION

### ELECTRONICS RADIO

Modern Completely Equipped Laboratories

DAY AND EVENING CLASSES

G.I. Approved—Veterans Receive Subsistence

ENROLL NOW!

**ELECTRONICS INSTITUTE, INC.**

21 Henry, Detroit 1, Mich.

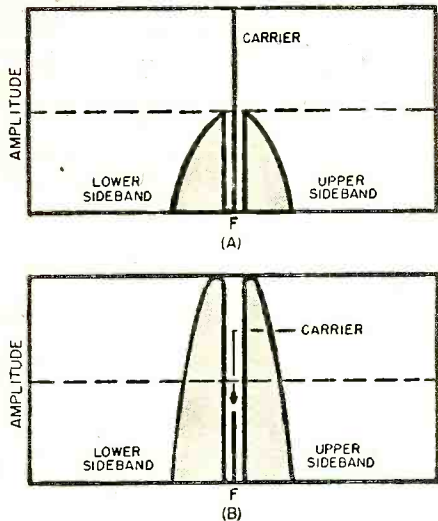

Fig. 4. Expanded super-modulation possibilities with greatly increased talk power and reduced interference.

bias rectifier, a pair of 866A's as rectifiers for the low voltage supply, and a second pair of 866A tubes are used as high voltage rectifiers.

Operational tests of 900-A transmitters using elementary super-modulation as described so far were as follows: In one case, power input to the power amplifier tube was 3000 volts at 305 ma., or 915 watts, while the power input to the positive modulator tube was 3000 volts at 25 ma., or 75 watts. This was a total power input of 990 watts at no-modulation carrier level.

Output was 3.3 amps. into a 72 ohm load, representing 800 watts of carrier output or a plate efficiency of 80 per-cent. With modulation, the measured current through the load was 4.1 amps. or 1210 watts.

The r.m.s. power output increase over carrier level was 410 watts or about the customary 50 per-cent increase by modulation. The .8 amp. increase represented the usual 22½ per-cent increase over the unmodulated carrier level.

At this modulation level, with narrow bandwidth and other advanced principles to be described in detail later, input to the power amplifier tube was reduced to 600 watts, represented by a plate voltage of 3000 volts at 200 ma. At a plate efficiency of 75 per-cent this allowed a semi-suppressed carrier output of 450 watts. Input of the positive modulator tube was 960 watts on peaks, which allowed, at a plate efficiency of 85 per-cent, sideband power production of 800 watts, over and above the 450 watts of semi-suppressed carrier power output of the power amplifier.

Therefore, with the plate power input of 1560 watts for carrier and modulation, we have in the output during positive modulation, about 450 watts of semi-suppressed carrier power and 800 watts of sideband power. This is 400 watts in each sideband. This represents about twice the normal sideband or talk power.

3

OZ. OF SMOOTH PERFORMANCE



ILLUSTRATION ACTUAL SIZE  
Dimensions  
2" diameter x 1¼" thick  
Metal cable stem—11/16"

## TURNER MODEL L40 Crystal Microphone,

A special purpose microphone  
of many uses

Small, lightweight and inconspicuous, the Turner Model L40 can be worn in the lapel, held in the palm of the hand, or concealed. Highest quality moisture sealed crystal produces high signal level. Engineered by Turner to give crisp, clear speech reproduction. Widely used for sales demonstrations, public address, call systems, sound re-inforcing, and recording systems. Also used in dictographic and detective work. Comfortable to wear. Alligator clip secures unit to clothing. Finished in satin chrome. Complete with 20 ft. of attached flexible cable.

### Model 3H—L40

• The Turner "third hand" and L40 microphone. A special combination for mobile sound work and call systems where operator must have both hands free. Ideal for sales demonstrators. The 3H slips over the head. Holds microphone close to mouth! Adjusts to any position. Also available with microphone switch at extra cost.



Ask your dealer

THE TURNER COMPANY

900 17th Street N. E., Cedar Rapids, Iowa

Microphones BY TURNER

Licensed under U. S. patents of the American Telephone and Telegraph Company, and Western Electric Company, Incorporated. Crystals licensed under patents of the Brush Development Company.



# New JERROLD BOOSTER GIVES YOU BETTER TV RECEPTION

## ELIMINATES INTERFERENCE

This new Jerrold Booster eliminates all interference from FM, Short Wave, Amateur, standard broadcast, and TV interchannel interference. This means steady, clear pictures that do not snowstorm, fade or fuzz.

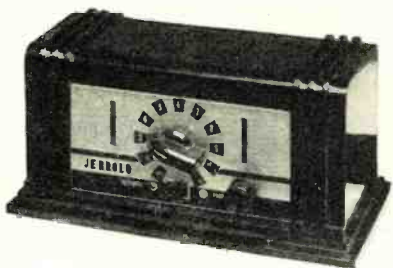

## BETTER RECEPTION IN FRINGE AREAS

Because of a minimum gain of 30 Db across the entire 6 megacycle bandwidth of all TV channels, you can see TV in fringe areas where it could never be seen before. Over six thousand Jerrold Boosters are now working in fringe areas, many of them from fifty to a hundred miles from the nearest transmitter.

## MULTIPLE UNITS ON ONE ANTENNA

The new Jerrold Booster is a boon to hotels, clubs, apartments and dealer showrooms. Only one antenna need be used when the Jerrold Booster is attached to each receiver. Each receiver can then tune in any station—with all signals working independently from one antenna.

## USE AN INDOOR ANTENNA

Most city locations can use an indoor antenna with a Jerrold Booster. Often just a wire tucked under a rug or behind the receiver is more than enough antenna to produce an excellent signal.

You can see the new Jerrold Booster at your favorite radio distributor or parts jobber. Write to us for FREE booklet.

**3450**  
LIST

**JERROLD ELECTRONICS, INC.**

121 N. Broad Street  
102

Philadelphia, Penna.

Examination of past practice in this system shows why there is such a great difference in talk power efficiency. Limited carrier and sideband output due to required reserve tube capacity for upward modulation, is not needed in this system. The direct application of the positive modulation energy, for the production of sideband power, is in the form of additional audio triggered r.f. voltage added to the output power. This eliminates three or more functions necessary in conventional practice, where first the high power modulating audio must be generated, and then matched and transferred to the plate of the modulated tube.

Then the modulated tube transfers this energy to the power amplifier plate tank circuit, which in turn adds the limited sideband power to the carrier power output.

Dispensing with these troublesome connecting links between the modulation energy and the carrier itself, allows direct carrier super-imposition by the modulation energy for sideband power production.

Further study shows considerable input power wasted in the production of modulation energy for sideband power in conventional practice. Carrier level plate power input in case of the low-level system represents wasted power under no-modulation conditions; about equal to the wasted power input necessary to generate the negative modulation, in the plate modulated system.

In the new system this power input waste is eliminated as the modulator tube consumes power only when needed for positive modulation, with high power amplifier plate efficiency, and little power consumed for negative modulation.

Where the same tube is effectively used to produce both carrier and modulation in plate modulation, there is no direct connection between the class

B modulators and the carrier. The power amplifier must produce the modulation as well as the carrier, as the class B modulators simply increase the plate input of the modulated tube.

Later study of this system in expanded performance and efficiency, with methods of procedure beyond that presented so far, will be of considerable interest. Fig. 4A shows a conventional carrier of approximately 800 watts or plus 51 db. This is about that obtained from a plate modulated or NBFM 1 kw. transmitter.

Of the 400 watts of maximum sideband power, that in one sideband is 200 watts or about plus 45 db. This is 6 db. below the carrier or interference level. Noise or interfering heterodynes at the plus 51 db. level smother the intelligence or talk power.

However, in the expanded form of super-modulation, as covered in the following article, transmission and reception conditions are reversed with the sideband power level far above the carrier or interference level.

This is accomplished by further increased sideband power and a high degree of semi-suppression or compression of the carrier, with results somewhat as shown in Fig. 4b. Non-modulated carrier power of about 800 watts or plus 51 db. is, with full modulation, reduced to about plus 42 db. as at 4B, or 8 to 10 db. below that of the plate modulated carrier or interference level.

Total sideband power of about 1600 watts then allows about 800 watts at plus 51 db. in each sideband or 6 db. more than in Fig. 4A.

By increasing the sideband or talk power level by 6 db. or more in one direction, and the simultaneous reduction of the carrier interference level by 6 db. or more in the other direction, we have a total difference of 12 db. or more in intelligence transmission efficiency.

*(To be continued)*

This new 300-foot aluminum-sheathed tower which will enable scientists to make extensive microwave experiments, was opened recently by Federal Telecommunication Laboratories, Inc., at Nutley, New Jersey. The laboratories which are housed in this modern building are research headquarters for International Telephone & Telegraph.



**RADIO & TELEVISION NEWS**

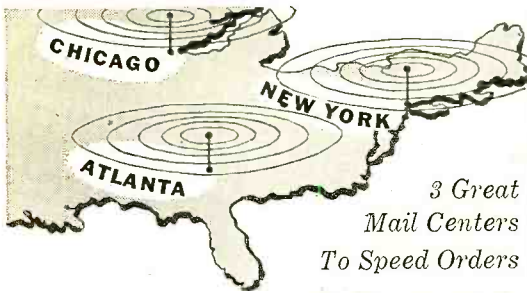

3 Great  
Mail Centers  
To Speed Orders

# LAFAYETTE-CONCORD

## ELECTRO NEWS

29 Years of Service—500,000 Satisfied Customers

# Great New Radio Merger Announced!

Below are shown 3 typical Lafayette-Concord values. Our shopping scouts will comb the country to bring you best-buys like these every month. So keep your bargain-hunting eye on Lafayette-Concord. You'll be missing plenty if you don't.

**LAFAYETTE-CONCORD** unite. Form largest organization... offer biggest values... most complete stocks, fastest delivery.

### 3-TUBE PHONO AMPLIFIER,

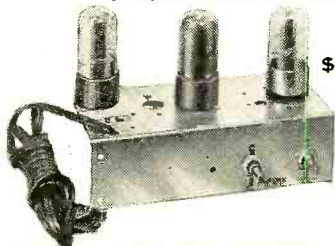

\$4.24

A compact, useful phono amplifier, ready for installation. Will work fine in hookup to record player. Uses 35Z5, 12SQ7 and 50L6 tubes. Audio stages are capacity coupled. Tone and vol. controls with 1/4" shafts. Plated chassis, 7 x 3 1/4 x 2". Including tubes, at a *slam-bang* low.....

### 5" PM SPEAKER

WITH OUTPUT XFORMER



Ideal to use with amplifier above or for replacement in radio receivers, call, paging and inter-communication systems. High quality, high permeability magnet. Formed one piece seamless cone. Dustproof spider and voice coil construction. 2-watt capacity. Voice coil impedance 3.2 ohms. Includes output transformer which matches 50L6 or 50B5 tubes. *Only Lafayette has it for*

\$4.24

### EXTRA SPECIAL!

### 2 STATION INTERCOM BUY



### HOME • NURSERY • OFFICE GARAGE • STORE • FACTORY

Complete 2 way system. Ideal for a dozen uses right in your home or place of business. Install in 5 minutes with screw driver. Calls can originate from either end. A baby's whimper will pick up at 15 feet. So powerful remote will operate over 2,000' from master station. Plastic cabinets, tubes, 50' connecting wire, etc., included. Supply will be limited to readers of this magazine, so send coupon with order.....

\$12.95

It's special news - for you - this exciting combine of Lafayette and Concord. Special, because now you can get from the largest organization in the industry...

#### 1. GREATEST VALUES

Tremendous purchasing power makes possible the lowest prices in the industry. Lafayette buys in huge quantities... savings are passed along. Just look through our new catalog and see what we mean. Compare Lafayette parts, radios, equipment... dollar for dollar. See if you can match the value anywhere!

#### 2. BIGGER STOCKS

Lafayette's huge stocks are complete to the tiniest accessory. Thousands upon thousands of items including many hard-to-get today. Full assortments, of course, in ham and hi-fi gear. Sound Systems? You bet! Lafayette P. A. is years ahead in engineering, styling, matchless performance.

TELEVISION'S BIG NEWS - you can find the latest TV gear at Lafayette-Concord. Add dozens of AM and FM models, and kits of every size and type. Pages and pages of 'em in the catalog. And don't forget Lafayette's reputation as Test Equipment headquarters. Every known name is represented. Stocks are always complete and up-to-the-minute.

#### 3. FASTER DELIVERY

Pahokee, Fla., Paducah, Ky., or Painted Post, Wyo., no matter where you are - you save time when you buy at Lafayette-Concord. Three Big Shipping Centers, located in focal spots in the South, East, and West, speed your order the same day it's received. Yes sir, faster than you can say super-sonic, your order is being processed through the world's largest radio house - marked special all the way.

#### 4. ENGINEERING SERVICE

Stumped on a P.A. puzzler? Shoot the problem to our engineers - we hate to brag, but they're smart. And that goes for our entire staff of answer-men. Hi-Fi. Television (you'll run into lulus in TV), you think them up, we'll answer them promptly.

#### 5. OLD TIME RELIABILITY

For 29 years, Lafayette-Concord has been giving folks "the best at the fairest prices". This reliability is an old story to 500,000 satisfied customers... So why take chances on unknowns? Trade with good old reliable Lafayette-Concord - you'll be sure of a square deal.

There you have 5 good reasons, and you'll probably think of a few new ones yourself, once you start doing business with Lafayette-Concord. Don't forget, too, the convenient L-C outlets. Check the addresses below. When you're in the neighborhood, drop in. Whether you buy or chat, we think you'll like the way we do business.



**FREE**

### BRAND NEW CATALOG!

Don't confuse this big book with any catalog you've ever seen before! When you get your copy, you'll see why. *It's complete!* What a book to have! Page after page on television, hi-fi, radios, P.A., parts, tools, test equipment, etc., etc. Everything in radio is here. But that's only the start of the story. Lafayette-Concord prices are lowest - *get this FREE book now and see for yourself!*

### JUST OFF THE PRESS!

Whatever your interest in radio - service work, engineer, hobbyist, experimenter, beginner - there's more in this book for you than in any ever before published. *Don't delay.* Mail the coupon, on penny postcard.

### RUSH THIS COUPON FOR

### FREE CATALOG

AND FOR ORDERING:

LAFAYETTE-CONCORD, DEPT. RI-8  
100 Sixth Ave., New York 13, or  
901 W. Jackson Blvd., Chicago 7

Please rush FREE catalog No. 89

I enclose \$..... Please fill attached order.

NAME.....

ADDRESS.....

CITY..... ZONE..... STATE.....

**MAIL NOW**

# Lafayette Concord

100 SIXTH AVENUE, NEW YORK 13  
265 PEACHTREE STREET, ATLANTA 3  
24 CENTRAL AVENUE, NEWARK 2

229 W. MADISON STREET, CHICAGO 6  
110 FEDERAL STREET, BOSTON 10  
542 EAST FORDHAM ROAD, BRONX 58

September, 1948

# Be sure to use FREED TELEVISION COMPONENTS for DEPENDABLE performance

TELEVISION TRANSFORMERS—Used in television receivers oscilloscopes, test equipment and high voltage, low current power supplies.

FREED NO.	HV AC VOLTS	DC MA	RECT V A		FIL V A		LIST PRICE
F-950	1700	4	2.5	2.			\$10.25
F-951	2000	2	2.5	1.75	6.3	.9	\$12.10
F-952	2500	2	2.5	1.75	6.3	.9	\$13.35

TELEVISION TRANSFORMERS—Used for a plate supply in television receivers (12 and 15 inch tube.)

FREED NO.	HV AC VOLTS	CT DC MA	RECT V A		FIL V A		LIST PRICE
F-960	775	225	5	3	6.3	1.75	\$14.80
F-961	800	300	5	3	5.	6.	\$30.75

### TELEVISION TRANSFORMERS

FREED NO.	DESCRIPTION	LIST PRICE
F-970	Horizontal Blocking Oscillator Tr.	\$4.50
F-971	Vertical Blocking Oscillator Tr.	\$4.25
F-972	Vertical Output Tr. for Magnetic Deflection CRT.	\$8.50
F-973	Horizontal Output Tr. for Electrostatic Deflection CRT.	\$4.50

Send for Catalog

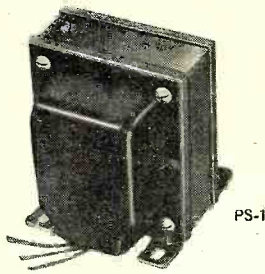

PS-1

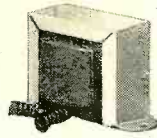

CH-1

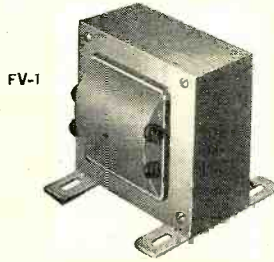

FV-1



CH-1

## International Short-Wave

(Continued from page 60)

be sent to R. H. Niino, Chief, Liaison Section, Broadcasting Corporation of Japan, Tokyo, Japan. (DXSA, South Australia)

Brazzaville, French Equatorial Africa, is verifying with a new card showing a typical African scene; details are on reverse side. (DXSA, Sou. Australia)

QRA of XURA, Taiwan, China, is Taiwan Broadcasting District, Chong Sun Park, Taipei, Taiwan, China. (Kary, Pa.)

All India Radio, Delhi, India, appears to verify by personal letter, enclosing schedules. (Stein, Calif.)

Radio France, Hanoi, Fr. Indo-China, verified by letter from P. Farines, station director. (Cushen, New Zealand)

Radio Nacional de Espana, Madrid, is sending a new type of card—showing radio mast, yellow background. (Pearce, England)

QRA of Radio Clube de Mocambique is Caixa Postal No. 594, Lourenco Marques, Mozambique, Port. East Africa. (Major, W. Australia)

EAJ-43, Canary Islands, verifies with a nice card, but is slow in replying; QRA is Radio Club Tenerife, Estaciones EAJ-43 y EA8AB, Apartado 225, Santa Cruz de Tenerife, Canary Island (Islas Canarias).

YV3RN, Barquisimeto, Venezuela, verified promptly; gave QRA of Radio Barquisimeto, Apartado 76, Barquisimeto, Venezuela. Frequency is 4.990. (Cohon, N. Y.)

### Club Notes

**United States**—A group of DX fans in Dallas, Texas, recently organized a new club called WWDXS (World Wide DX Society), with Jim Bithas as manager and Johnny Puckette as secretary. A bulletin is being sent to members once every two months but it is hoped to make this monthly soon; publication is called "The Rag Chewers Circle." Membership at present is free. For application blanks and details write Jim Bithas, 1814 South Marsalis Ave., Dallas 16, Texas. (Cooley, Pa.)

### This Month's Schedules

(NOTE: Shortly, some stations will be returning to winter schedules, after having observed Summer Time; in such cases, schedules will probably be one hour later than listed herein.—K.R.B.)

**Anglo-Egyptian Sudan**—Radio Omdurman's 31-r. outlet has changed frequency from 9.557 to 9.607. (Bluman, Eritrea, via Stockholm Radio)

**Austria**—KZCA, formerly KOFA, 7.220, Salzburg, "Blue Danube Network," is heard in Britain around 0330; gives call at 0400. (Pearce)

**British Honduras**—ZIK2, 10.598, Belize, is scheduled daily around 1330 with newcast; but sometimes is irreg-

**RADIO & TELEVISION NEWS**

Ask your Jobber. If he can't supply you—Order Direct from  
**FREED TRANSFORMER CO., INC., DEPT. SR, 72 SPRING ST., NEW YORK 12**

## LIFE-SIZE TELEVISION is here!



CORTLEY MODEL #720

Cortley Television Corporation brings you the greatest advancement in television since the invention of television itself. A Projection Television Receiver that throws an amazingly clear image, varying in size from several inches up to 6 x 8 feet, onto a screen—just like a home movie projector. Cortley installations in New York have been tested and proven successful for two years.

### UNLIMITED SALES OPPORTUNITIES

Your sales possibilities with the CORTLEY PROJECTION TELEVISION RECEIVER are absolutely unlimited. Bars, Restaurants, Schools, Clubs, Churches, Hospitals, Resorts—these are but a FEW prospects! They have been clamoring for television that can be seen by several hundred people at one sitting—and now you can supply them.

Get in on this brand new, easy-to-sell market. Be the first in your community to fill the enormous need. Send for full information and price today!

A limited number of Cortley Distributorships are still available. Write for particulars now.

### CORTLEY TELEVISION CORP.

Dept. A, 15 West 27th Street  
 New York 1, N. Y. Tel. MU 3-3624

\*\*\*\*\*

## R-L SPECIALS for IMMEDIATE delivery

### TO CELEBRATE OUR REOPENING IN OUR NEW LOCATION!

- 5" PM SPEAKERS ..... Ea. \$0.99
- 6" PM SPEAKERS ..... Ea. 1.69
- 8" PM SPEAKERS ..... Ea. 2.69
- 10" PM SPEAKERS with 20 oz. slug ..... Ea. 4.49
- 12" PM SPEAKERS with 22 oz. slug ..... Ea. 5.75

10" OSCILLATING FANS..... Ea. \$9.34  
 Underwriters Approved

AC 6' PURE RUBBER CORDS WITH PLUGS..... 8 for \$1; 25 for \$2.50  
 72" DISAPPEARING CAR ANTENNA

Reg. \$7.50 value..... Ea. \$2.95  
 Lots of 3 or more..... Ea. 2.75  
 No. 47 PILOT LIGHTS..... Per 100 \$4.80

We Buy and Trade Test Equipment



608 West Randolph Street  
 Dept. N9 Chicago 6, Illinois



# RADIO CABINETS

**DIRECT FROM  
MANUFACTURER'S CLOSEOUT**

Pay Less Than Manufacturer's Cost

- (A) Leatherette covered.  $8\frac{7}{8}$ " x  $5\frac{3}{4}$ " x  $6\frac{1}{2}$ ". Cutout as shown. Complete with dial scale, grille, dial glass. No. 268. **\$1.50**
- (B) Plastic, Brown,  $6$ " x  $10\frac{1}{4}$ " x  $6\frac{3}{4}$ ". Cutout as shown. Complete with dial scale, grille, dial glass. No. 274. **\$1.50**
- (C) Leatherette covered.  $12$ " x  $11\frac{1}{2}$ " x  $7\frac{1}{2}$ ". Cutout as shown. Plastic handle. Complete with dial face, dial glass. No. 261. **\$1.95**
- (D) Leatherette covered.  $9\frac{1}{2}$ " x  $12\frac{1}{2}$ " x  $5$ ". Leather handle. White—brown trim. Cutout as shown. No. 286. **\$1.50**
- Same—in brown and tan. No. 285. **\$1.50**
- (E) Walnut.  $11\frac{3}{4}$ " x  $7$ " x  $6$ ". No. 276. **\$1.95**
- (F) Plastic.  $10\frac{1}{2}$ " x  $6$ " x  $6\frac{3}{4}$ ". Cutout as shown. Accessories as above. Choice blue, black, yellow. No. 273. **\$1.50**

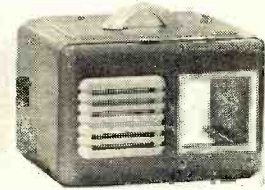
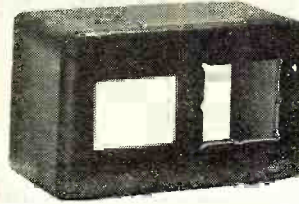
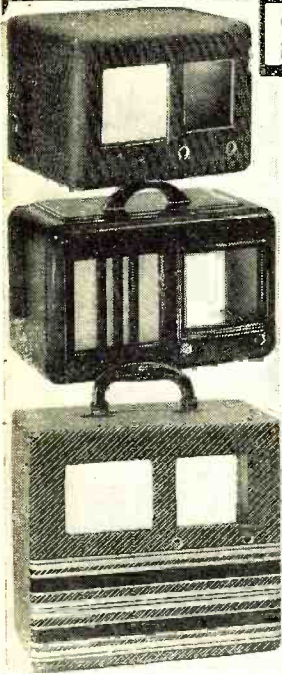

## SHIELDED LEAD IN WIRE

No. 20 Stranded.  $\frac{1}{2}$ " rubber covered, copper shielded. 200'. **\$2.50**

## HOOK-UP WIRE

No. 18 Solid or stranded. **\$6.50** per 1000 ft.  
No. 20 Solid or stranded. **5.50** per 1000 ft.  
No. 22 Solid or stranded. **3.75** per 1000 ft.  
No. 24 Solid. **3.00** per 1000 ft.

## TIME DELAY RELAY

Type Galvin 59C48746. Set for 2 seconds. 50-70 cy. 115V. Calibrated at 60 cy. SPDT Switch. 10 Amps. ea. **\$5.00**

## SPEAKERS

3" P.M. **\$ .98**  
3" P.M. with 50L6 Output Transformer **1.29**  
4" P.M. with 50L6 Output Transformer **1.39**  
5" P.M. with 50L6 Output Transformer **1.49**

## AMPHENOL 2 METER DIPOLE

144-148 MC.

Furnished complete with all parts and instructions for assembling, including 75' amphenol 300 ohm twin lead.

Affords consistent performance in the high frequency band. A specialized antenna designed for optimum performance over the band or which it is designed. May be assembled for either horizontal or vertical polarization.

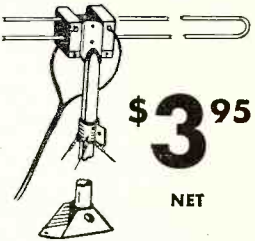

# SAVE DOLLARS ON DOLLAR ITEMS!

## CONTROLS

Choice of 300; 500; 1000; 3000; 5000; 10,000; 50,000; 250,000 Ohms. Choice of any 7 for **\$1.00**

## P. L. 68 PLUG P. L. 540 PLUG

Choice. **10** for **\$1.00**

## METAL DIAL SCALE

$2\frac{3}{4}$ " dia. Calibrate 0-100, 180 degrees. Fits  $\frac{1}{4}$ " shaft. 7 for **\$1.00**



## OUTPUT TRANSFORMER FOR 50L6

3500 Ohm to 3.2 Ohm voice coil. 39¢ ea. **3** for **\$1.00**

## PILOT LITE ASSEMBLY

$\frac{1}{2}$ " white, red, green or amber. **5** for **\$1.00**

## TIMING RELAY

General Electric. No. CR-2791-J106G9. 24V DC. **2** for **\$1.00**

## MOLDED PAPER CONDENSERS

500 mmfd. 600V.  $\frac{1}{2}$  postage stamp size. **20** for **\$1.00**

## MINIATURE TUBE SOCKETS

7 Prong, Bakelite. Furnished with retainer ring. **12** for **\$1.00**

## MAGIC EYE TUBE ASSEMBLY

Used with 6AF6. **2** for **\$1.00**

## POLYSTYRENE WALKIE TALKIE ANTENNA PLUG IN COIL

With sockets. Choice of:  
4225-4425 KC 4425-4625 KC  
4845 KC 5305 KC  
5300-5500 KC **10** for **\$1.00**

## FLEXIBLE SHAFT COUPLINGS

Ceramic  $\frac{1}{4}$ " to  $\frac{1}{2}$ ". Bakelite  $\frac{1}{4}$ " to  $\frac{1}{2}$ ". Choice **8** for **\$1.00**



## SLIDE RULE POINTERS

As shown. 1". As shown. 2". **20** for **\$1.00**

## OCTAL SOCKETS

Amphenol.  $1\frac{1}{2}$ " Mounting ctr **25** for **\$1.00**

## PANEL BEARING AND SHAFT EXTENSION

$\frac{1}{8}$ " dia. x  $1\frac{1}{2}$ " shaft. Fits  $\frac{3}{8}$ " hole. **8** for **\$1.00**

## MOLDED PAPER CONDENSERS

.1 mfd—400V. Domino size. **12** for **\$1.00**

## SLIDE SWITCHES S.P.D.T. SLIDE SWITCHES D.P.D.T.

Choice. **8** for **\$1.00**

## BANANA PLUG JACK

$\frac{1}{8}$ " Dia. hole.  $\frac{1}{2}$ " O.D. x  $1\frac{1}{8}$ ". **20** for **\$1.00**

## W.W. RESISTORS

1 ohm 10W. **20** for **\$1.00**

## RELAY SPST

110V A.C. **1.00** ea.

## LOOP ANTENNA

For portable AC-DC sets. **6** for **\$1.00**



## MALLORY TYPE PHONO JACK

**20** for **\$1.00**

## OSCILLATOR COIL

For use with 6SA7, 12SA7. etc. **5** for **\$1.00**

## BAKELITE BINDING POST

$\frac{3}{8}$ " Dia., non-removable screw top. With 10-32 x  $\frac{3}{4}$ " screw. **12** for **\$1.00**

## TUNING SLUG ASSORTMENT

40 assorted, small, medium, large. **40** for **\$1.00**

## CERAMIC CONDENSERS

250 mmfd. and 1000 mmfd. Choice. **20** for **\$1.00**

## LOW IMPEDANCE EAR PHONES

ANB-H-1. Used, less headband. Guaranteed Perfect. **3** for **\$1.00**

## PHONE JACK

JK 34A. Fits P.L. 55 Plug. **10** for **\$1.00**



## CLOSED CIRCUIT JACK

Fits PL-55 Plug. **7** for **\$1.00**

## RUBBER GROMMETS

150 assorted. Sizes  $\frac{3}{8}$ " I.D. to  $1\frac{1}{2}$ " I.D. Will cover most requirements. **\$1.00**

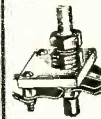

## CARDWELL TRIMMER

10 mmfd. Max—1.2 min. Isolantite assembly for stability.  $1\frac{1}{2}$ " x  $1\frac{1}{4}$ ". **2** for **\$1.00**

## TANK COIL

Type C-447. 14 Turns. Freq. range 8-11 mc. With fixed coupling links. 5 Banana plug mounting.

TANK COIL. Type C-449. 8 turns. Freq. range 14-18 mc.

TANK COIL. Type C-449B. 6 turns. Freq. range 14-18 mc. with rotary  $1\frac{1}{2}$ " turn coupling link wound inside coil. Choice. **20** for **\$1.00** ea.

**TERMS:** All items subject to prior sale. Prices subject to change without notice. Minimum order \$2.00. No C.O.D.'s accepted less than \$5.00. Please remit 25% deposit on all C.O.D.'s over \$5.00. All shipments made F.O.B. Chicago, Illinois.

# IRVING JOSEPH

220 S. Halsted St.,

Chicago 6, Ill.

# JUST OFF THE PRESS

## YOUR *NEW* COMPLETE W. R. L. CATALOG

CONTAINING  
**Everything New in Radio**

Sent FREE at your request

**GET YOURS TODAY!!**

## IT PAYS To Buy Hallicrafters

It pays to buy Hallicrafters from Leo because every model is carried in stock for immediate delivery. Use your present receiver as a trade in. Take advantage of my *E-Z-Payment plan* which is the lowest in the country. You'll enjoy dealing with the World's most personalized radio supply house. Let's get acquainted. *Every order is handled by me personally.*

Write to Leo I. Meyerson WØGFO

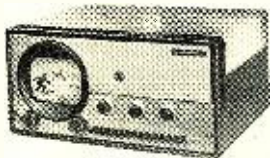

**T-54 TELEVISION SET**  
Here is the hottest television set on the market for the money. **\$169.50**



**S-53 RECEIVER**  
Eight tubes—5 bands from 540 KC to 54.5 MC. Here is a popular receiver for both the amateur & short wave listener. **\$79.50**



Look me up in Booth 142 at the National Ham Convention in Milwaukee, Sept. 4-6.

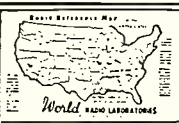

### GIANT RADIO REFERENCE MAP

Just right for your control room wall. Approximately 28" x 42". Contains time zones, amateur zones, leading shortwave stations, monitoring stations. Mail coupon today & 25c.

WRITE — WIRE — PHONE 7795



WORLD RADIO LABORATORIES  
744 West Broadway  
Council Bluffs, Iowa

Please send me:  
 Radio Map  
 New Catalog

Name .....

Address .....

City..... State.....

Send Free Hallicrafter catalog

R-9

**RADIO MEN**  
WRITE FOR  
**BARGAIN CATALOG OF RADIO PARTS**

BUYERS SYNDICATE  
30 TAYLOR STREET  
SPRINGFIELD 3, MASS.

BUYERS SYNDICATE  
30 TAYLOR ST., SPRINGFIELD 3, MASS.

**CUTS MACHINE SCREWS** without damaging threads!  
**\$3.95**

**SHEARITE**

Amazing new AMP "SHEARITE" hand tool shears machine screws right off! No burrs, no smashed threads! For #10-32, 8-32, 6-32 and 4-40 screws—brass or steel. Cuts and strips electrical wire too, sizes 22-10. Only \$3.95 complete, postpaid.

**RICHARD RENNER ASSOCIATES, Dept.—RN**  
315 South 15th Street, Philadelphia 2, Pa.

ular in signing on; has been heard coming on at various times between 1330 and 1340. (Stark, Texas) This station is usually weak, is seldom audible here in northern West Virginia. News is mostly local items, according to Bill Arthur, Charleston, southern West Virginia, who has better luck with this one than I do!

*Celebes*—Radio Makassar, 9.550, is heard in Australia at 0445 with music. (Sanderson) According to URDXC, YFA4, 9.550, with YFA10, 5.030, in parallel, has a new schedule of Monday-Saturday 0400-1000, 1730-1930; Monday-Friday 2200-0130; Saturday 1900-0130; Sunday 0400-1000 only; English commentary Monday and Friday 0750-0800; all reports are answered, correct ones are verified; power is now 10 kw.

*China*—Some weeks ago, Park, British Columbia, reported a new Nanking outlet, XGRD, 17.765, testing from 1930 in English, relaying XGOA's 11.835, and beamed to the West Coast of North America; excellent signal, drowning out KWID's QRM; a check here in West Virginia and by Kary in Pa. revealed only a "mild" heterodyne on KWID's 17.76 outlet. Park reported frequent announcements were given in English and that they asked for comments and reports to XGRD, c/o Central Broadcasting Administration, Nanking, China; had news 2010 or 2015. Later, Radio Australia listed the new 17.765 outlet as XGRZ and schedule of 2115-2155, relaying XGOA. Balbi, Calif., reported hearing it on the 2115-2155 schedule, but with severe QRM from KWID; while frequency of XGRZ appears approximately 17.761. Balbi says he cannot entirely separate it from KWID.

*Colombia*—URDXC lists as a new outlet, HJWO, Bogota, on 6.270, heard 2030-2300.

*Honduras*—HRA, "La Voz de Lempira," Tegucigalpa, has moved from 6.048 to 9.045 where is heard to 2300, through CWQRM. (Sutton, Ohio)

*Israel*—According to Herbert Bluman, Eritrea, Nor. Africa, "This is Kol-Yisrael, the Broadcasting Station of the State of Israel" is the announcement used during English periods by the new Tel Aviv outlet heard on approximately 6.835; news is broadcast at 2230, 0445, and 1230; latest schedule appears to be 2155-2245, 0000-0015, 0330-0500, 0600-0615, and 0930-1345 daily. The call during Arabic periods is "Mehattat Isra-il." During Hebrew periods this station introduces itself as "Kol-Yisra-el," except at 0330 when the call "Kol Ha-Haganah," preceded by fanfare, presumably begins a special Haganah broadcast. Mr. Bluman informs that of the Haganah network of five low-powered short-wave transmitters, only Radio Kol-Hagalil, "The Voice of Galilee," probably located at Tiberius, has been heard lately; frequency is approximately 7.000, daily 1130-1200 or later. The Haganah stations—Jerusalem, approximately 8.100; Haifa, 6.500, and Radio Negev, 3.800—are definitely still

**RADIO & TELEVISION NEWS**

on the air since their broadcasts are frequently quoted in Tel Aviv news-casts, but they have not been heard by Mr. Bluman since Israel adopted *double* Summer Time (GMT plus 4 hours) at the end of May. (Stockholm Radio) Nilsson, Sweden, lists frequency of Tel Aviv to me at 6.830. Pearce, England, says Tel Aviv, which he lists 6.835, when signing off at 1245 says, "Shall be with you again tomorrow morning at 7:30" (local time); apparently has altered schedule as formerly had news at 1330, now is at 1230.

**Jamaica**—VRR4, 11.595, Stony Hill, is often heard at excellent level around 1015 calling VFI2 (or VSI2?), Turks Island. (Arthur, West Virginia)

ZQI, Kingston, operates 1600-1730 on 4.92; 1930-2200 on 3.48; has local and world news 2000, and possibly at 1715. (Southall, Pa.)

**Java**—Capt. M. J. O. Branse, Territorial Welfare Officer in Central Java and Chief Radio Welfare Section, Semarang, has informed Skoog, Sweden, that the station is using two transmitters—YDH on 2.500, and YDH-2 on 11.030; programs in Dutch are radiated daily 2100-2200 and 0600-1000, and in Indonesian 2300-0000, and 0400-0600; transmissions at 2100 and 0400 are opened with the familiar march, "Entry of the Gladiators." The day's operations close at 1000 with announcement first in Dutch, and then in *English*; latter is, "Listeners all over the world are requested to send their reports or QSL cards to Radio Semarang, Java, Indonesia." The station relays some programs from Batavia.

PLS, 10.365, Batavia, good in Newfoundland at 1730-1830. (Peddle)

An unidentified Indonesian has been heard irregularly on West Coast for several months on approximately 11.120; bad CWQRM. (Dilg, Calif.)

**Radio Indonesia** has been heard in Australia on 6.17 at 0630 with music for local listeners. (Sanderson)

Dilg, Calif., says "the Bandoeng outlet on 10.600 seems to be an alternate; have never heard it when 10.067 is in use." He says that a Javan outlet heard on about 9.845 seems to have an irregular sign-off, appears to remain on longer Sundays at which time may be relaying from Holland since they have a musical comedy program that day opening at 0800; this may be a Batavia station, used for phone work with U. S. at times; weekdays signs off usually around 0745. He believes the Javan on approximately 13.370 may be Soerabaja which last year used 13.601 and which during the winter moved to around 7.270/7.280; sign-off on 13.370 is 0930 with musical signature of "Aloha"; uses Indonesian language, and is a fair signal.

**Kenya Colony**—VQ7LO, 4.855, Nairobi, is being heard at improved strength in New Zealand just prior to closing around 1400, (Clark) Pearce, England, reports frequency as 4.850; heard closing 1400 with time pips and  
(Continued on page 134)

# PROJECTION TELEVISION!

## CONVERT YOUR RCA 630 OR CROSLY 307 TO THIS AMAZING TELEVISION CONVERSION OF 1948!

The gigantic picture this set projects must be seen to be believed! One set converted by a Los Angeles company was demonstrated at the Shriner's Temple during the Rose Bowl game. It was seen by 4800 people at one sitting! A 12 x 16 foot rear projection plastic screen of our type was used.

The complete kit for RCA 630 or Crosley 307 conversion—less chassis—includes necessary condensers, resistors, RF power supply, kinescope tube, lens, stand, front plate, ring for mounting lens and full instructions. **\$336<sup>95</sup>**

Net Price, Complete

### F 1.9 TELEVISION PROJECTION LENS

Dimensions: Length 7", Diameter 4 1/4"

F 1.9 EF. 5 in. (127.0 mm). This lens incorporates in barrel a corrective lens for use with a 5TP4 projection tube. It is easily removable for use with flat type tubes. Lens can be utilized to project picture sizes from several inches to 7 x 9 feet. Made by Bausch & Lomb Optical Co.

Net Price ..... \$125.00  
Mounting ring available for above lens ..... \$2.50



G. E., Philco, Transvision, etc. — practically any set using electro-magnetic deflection can be converted to Projection Television.



### 5TP4 PROJECTION KINESCOPE TUBE

Features a metal backed white fluorescent screen having high brightness and contrast. Net Price ..... \$67.50

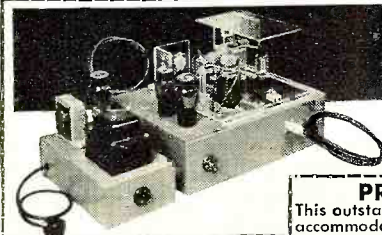

### 30 KV RF POWER SUPPLY

Dimensions: Length 14", Width 11", Height 11 1/4"

New improved unit of exceptional regulation. Has a focus control pot built in for use with 5TP4 Tube. Voltage variable from 27 to 30 KV. Supply utilizes 6 tubes. Net Price, including DC Power Supply ..... \$99.50  
Also available with voltages up to 60 KV. Write for information, stating your requirements.

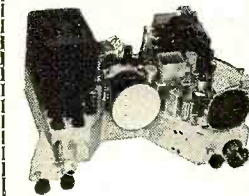

### PROJECTION TELEVISION CHASSIS

This outstanding set using famous 630 circuit is a modified version to accommodate 5TP4 Projection Tube. The intense source of light on the face of the projection tube enables set to project pictures onto screens of sufficient size to be utilized by auditoriums and small theaters. FEATURES: Set, less 30 KV RF Power Supply, contains 30 tubes. Full 13 channel coverage; FM sound system; A-F-C horizontal hold; stabilized vertical hold; 2 stages of video amplification voice saturation circuits; three stage sync separator and clipper; four mc. band width for picture channel. Exclusive Cutout Relay to protect projection kinescope in the event of sweep failures!

Net Price—Chassis Only (Includes all tubes less projection tube shown above) ..... \$340.00  
Chassis as above, but designed for 10" or 15" tube use, relay circuit not included. Set complete less kinescope ready to operate— Net Price \$298.00



### HIGH VOLTAGE TELEVISION CAPACITORS

SPECIFICATIONS: JEFFERS TYPE SKC CAPACITORS

Type	Capacity	Operating Voltage	Size			Net Price
			A	B	C	
SKC 10-10	1000 mmfd	10,000	1 3/4"	1 1/2"	.565"	.45 ea.
10-20	500 "	20,000	2"	1 1/2"	.800"	.84 ea.
10-30	300 "	30,000	2 1/4"	1 3/4"	1.05"	2.10 ea.
SKC 20-10	1600 mmfd	10,000	1 3/4"	1 3/4"	.535"	2.32 ea.
20-20	1200 "	20,000	2"	1 3/4"	.800"	3.36 ea.
20-30	600 "	30,000	2 1/4"	1 3/4"	1.05"	4.17 ea.
SKC 30-10	3200 mmfd	10,000	2 1/4"	1 3/4"	.535"	4.17 ea.
30-20	2500 "	20,000	2 1/2"	1 3/4"	.800"	5.01 ea.
30-30	1200 "	30,000	2 3/4"	1 3/4"	1.05"	5.85 ea.

### STAND FOR PROJECTION TELEVISION SETS

Dimensions: Height 23", Width 25", Depth 18 1/2".

For use with RCA 630 chassis or Crosley table model sets. Unit mounted on ball bearing soft tired wheels. Depth is designed to accommodate RF Power Supply. Open grill allows free circulation of air. This stand a natural for mounting scopes and other lab. equipment for easy mobility. Specify whether for Television use or shop. Stand as shown in top photo.

Net Price ..... \$31.50

### NEW REAR PROJECTION PLASTIC TELEVISION SCREENS

The screen surface consists of a conglomerate arrangement of microscopic plastic crystals that "Pin Point" the projected image providing unexcelled angular viewing with a minimum loss of projected light. It is estimated that there is a loss of approximately 10% of light viewing the image at 45 degrees off center. Light transmission percentages are controlled to obtain the maximum efficiency of the television optical projection system.

The percentage of 80% of transmission has been determined as that providing maximum efficiency. Stock sheets are available from 3 x 4 feet down. Specify inside dimensions of screen desired. If larger sizes are required, they can be made to order.

The special construction of this screen material permits its use in places where even direct light falls on the screen. The screen is designed to give maximum black and white quality when used with a new 5TP4 Tube. Net price of Rear Projection Screen, per sq. foot \$3.00

### FRONT PROJECTION SCREENS

High Efficiency, Crystal Beaded Roll-up Type.

Size	Price
30"x40"	\$10.00
37"x50"	14.00
45"x60"	20.00
52"x72"	25.00
5'x7'	40.00
6'x8'	62.00
7'x9'	78.00

RCA PROJECTION TELEVISION COMPONENTS  
Send for FREE Catalog "A" of complete line

Include 25% Deposit With Order, Balance C.O.D.

**PIONEERS IN PROJECTION TELEVISION**  
**SPELLMAN TELEVISION CO., INC.**  
DEPT. A, 130 WEST 24th STREET, NEW YORK 11, N. Y. • AL 5-3680

# HOW' YOUR

# TV ?

Weak signals, "snowy" pictures can be corrected in your antenna system with a VEE-D-X installation.

getting pictures like this



or

pictures like this



The VEE-D-X long range antenna

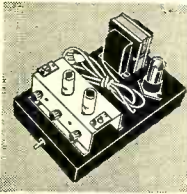

Two- or three stage Pre-Selector

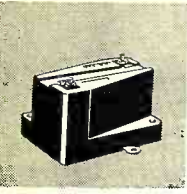

VEE-D-X lightning arrester

Distance from the transmitter to the receiver is becoming less a factor in determining good TV reception . . . VEE-D-X, the long range antenna, is pulling in stations regularly with clear, bright pictures for receiver owners more than twice the set manufacturers' recommended range. Receiver owners are cleaning up that "snow" and other interference in their receivers with a complete VEE-D-X installation.

In areas where the signal is extremely low, a VEE-D-X two stage—or three stage Pre-Selector solves the problem. It boosts the weak signal while isolating outside interference. Designed by experienced television engineers for those who want tops in TV reception, a Pre-Selector installed will show you what real reception is.

For protection against lightning on antenna installations, the VEE-D-X lightning arrester affords the maximum of protection with no line loss. Protection for your TV receiver and equipment.

**La POINTE PLASCOMOLD CORP.**  
UNIONVILLE, CONN.

# VEE-D-X

Adds more vision to television

## What's New in Radio

(Continued from page 78)

of aluminum foil laminated to heavy corrugated board which has been reinforced for strength and rigidity. The unit comes complete with a 50 foot, low-loss transmission line.

Priced moderately, the antenna is said to provide high gain and to eliminate television ghosts.

A data sheet, prices, and further details will be furnished by *The Workshop Associates*, 66 Needham Street, Newton Highlands 61, Massachusetts, upon request.

### CUSTOM BUILT CABINETS

*Nemes* of Chicago is currently offering a line of custom built cabinets to house radio and television receiver chassis.

One of the cabinets measures 38" high, 37" wide, and 18" deep. It is available in any desired finish. This particular cabinet will house a record changer, radio, separate speaker and has two record compartments.

The manufacturer invites inquiries on all types of radio and television cabinets. Address letters to *Nemes*, 2631 Lehmann Court, Chicago 14, Illinois.

### TV TEST EQUIPMENT

*Belmont Radio Corporation* has introduced a new line of *Raytheon-Belmont* television test and installation

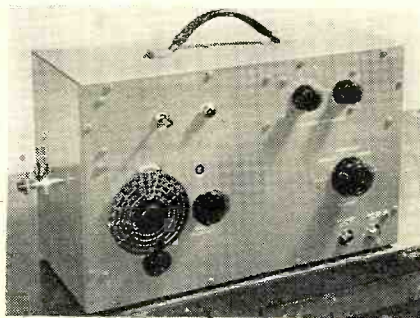

equipment which has been especially designed for the service engineer.

Three units are included in the new line; a composite video generator (Model 30G1); an r.f. alignment signal generator (Model 6G111); and an antenna alignment communicator (Model 3AW8).

The composite video generator provides all elements needed to give a complete "standard television video signal" and is housed in a small portable case. Troubleshooting and repair work can thus be carried out in the shop or in the home without waiting for a television transmitter to come on the air.

With the r.f. alignment signal generator, the service engineer obtains complete r.f. and i.f. signals for the analysis, testing, and alignment of television and FM receivers. In conjunction with the video generator and

any standard oscilloscope, this provides a complete portable television and FM service laboratory. The unit weighs 31 pounds.

A means of ready communication between the site of the antenna and the television or FM receiver is provided by the antenna alignment communicator. This a.c.-d.c. two-way communicator is a timesaver for the television installation crew.

A brochure covering this new line of equipment is available from *Belmont Radio Corporation*, 5921 West Dickens Avenue, Chicago 39, Illinois.

### RECORDER HEAD

*Webster Engineering Co.* of Cedar Rapids, Iowa, is now in production on a new magnetic tape recorder head for commercial and entertainment use.

This new head is of the plug-in type and fits into a standard 8-pin octal tube socket. A variety of coil arrangements and output impedances are available to suit the requirements of the individual user. When used with the proper circuit and amplifier, these heads are capable of high fidelity. Coils are arranged in a hum-bucking fashion and the steel cover helps eliminate hum and pickup.

Both the record-playback and erase heads are housed in identical cases and designed for use with standard ¼" magnetic tape. Heads may be supplied in a variety of colors to match or contrast with other mechanical parts. Head size is approximately 1¼" in diameter and 1" high.

Full details may be secured from *Webster Engineering Co.*, 421 Sinclair Avenue, S.E., Cedar Rapids, Iowa.

### RECORDER MECHANISM

*Crescent Industries, Inc.* has introduced a new combination record player and magnetic recorder-reproducer.

The unit records magnetically on a stainless steel wire up to one full hour program from any input source that can be fed into the associated amplifier equipment. The unit plays back magnetically and is capable of playing or recording on the wire from phonograph records. The company's special tone arm is incorporated in this unit.

Rewind is fast, five times faster than the recording speed. A single knob controls the mechanism. A special control assembly combines the me-



chanical and electrical control functions. The wire recorder automatically shuts itself off at the end of the wire, in all positions of operation.



### USN NOISE LINE FILTERS

10 Amps/130 VACDC Filters 0.1 to 1000mes. NEW SPECIAL \$1.29.  
30AMP/250VACDC Filters 0.15 to 30mes "C" cut for RCVRs. XMTRS Oil Burners, Refrig MCH tools. Signs. SPECIAL \$4.50. Filter Coils 12 Amp line use 4 for \$1.00. Parasitic Chokes HF .25 APR4 RCVR & COILS 30 to 4-100 me's. Write for full details.

ELECTRICAL WRENCHES Tool Steel... 2 for \$2.25

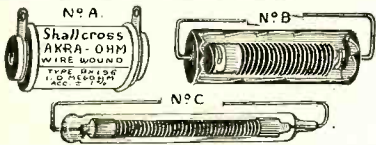

Precision Resistors for Meters, Bridges, Amplifiers, Radar, Television and Telephone equip. Standard Mfgs. Specialists in Precision RSTRS. Write Qty Prices. Over 2,000,000 RSTRS. in stock.

.116	170	680	2600	13500
.425	175	689	2700	14400
.7	182.4	700	2860	14460
1.01	200	705	4000	15000
1.75	220.4	808	3290	16500
3	230	900	3500	17500
4	240	917	3700	18380
5	250	1000	3760	19000
6	260	1056	4200	20000
7	275	1100	4300	21000
7.5	280	1110	4440	22000
8	290	1150	4500	22900

Other Values Available This Group. Write List.

10	300	1162	4750	23150
12	310	1200	4885	23400
14.2	320	1250	5000	24600
15	340	1322	5210	25200
17	366.6	1355	5200	26600
21	478	1495	5600	29000
25	390	1510	5910	29900
26	410	1600	6140	31000
30	418.8	1646	6300	35000
48	427	1670	6500	38140
50	450	1710	6990	39500
55	470	1740	7500	43000
60	478	1800	7930	48000
68	487	1830	8250	49000
75	520	1900	8700	52000
81.4	540	1960	9000	56000
90	575	2045	9500	61430
95	600	2080	10000	64000
100	612	2142	10500	68000
120	638	2160	11000	72000
125	650	2200	11500	80000
150	657	2300	12000	90000
165	673	2400	13220	95000

ABOVE SIZES EACH 30c.....TEN for \$2.50

100000	150000	240000	353500	575000
110000	155000	245000	380000	600000
150000	166750	250000	400000	620000
120000	180000	260000	402000	621000
125000	185000	268000	422000	654000
130000	201000	275000	458000	750000
135000	220000	294000	478000	761300
140000	225000	307500	500000	800000
141000	229000	314800	520000	800000
145000	235500	330000	521000	830000
127000	238000	335000	570000	950000

ABOVE SIZES EACH 40c.....TEN for \$3.50

1 Meg	2 Meg	3.5 Meg	4.23 Meg	10 Meg
1.2	2.855	3.673	4.5	11.5
1.5	3	3.9	5	12.83
1.8	3.673	4	9.05	20

ABOVE SIZES EACH 75c.....TEN for \$6.50

VACUUM HIACCY 1/2% HILVOLT RSTRS (C) 1.2, .25, .6, .75, .83, .99 megohms 1, 1.5, 2, 3, 37, 25 megohms. Glass vacuum sealed.

SPECIAL \$1.00 @.....TEN for \$ 7.50

MEGOMAX 10or12Meg/10KV/9W \$1.35 10 for 10.00  
MVZ8/25Watt/30Megohms/25KV \$1.98 @ 6 for 10.00  
MFBI05/1Meg/.5%accy/1ANR-29 \$1.98 @ 6 for 10.00

ABOVE SIZES EACH 25c.....TEN for \$2.50

BUSS HCM/4AG	25c
BUSS HKM/3AG	25c
Little Fuse 1077S/3AG	18c
Little Fuse 1087F/4AG	25c
Fuse Mtg Dual	10 for \$1.00
THERMOSTAT 95°F/20A @ 48c	
RELAY Time Delay 115VACDC/10 Amp. for 866A or 872 filaments.	\$1.49

HEINEMAN CKT BREAKERS (0ma 3, 5, 10, 15, 20, 30 & 40, 80, 100, 180 Amps. NEW, each, \$1.95; asstd. 10 for \$18.00

SO'D. KLIXON & CH 5, 10, 20, 25, 33, 35 & 60, 70Amps, 98c @ 10 for 8.00

ANTENNA Tuning Unit 1001A NEW 1KW/1.5to7mcs loose Coil Turns. CSD Rack mtg. 9.95

SIREN USN, NEW. OPERATES 2VACDC. Will work 0N 3Volts. ADJUSTABLE for Photoceol or BURGLAR Alarms, Boats, Cars, Busses, Trucks. SPECIAL, ea., \$2.98. 10 for \$25.00

BELL 115VACDC HOLTZER CABOT, New Adjustable.... \$1.29

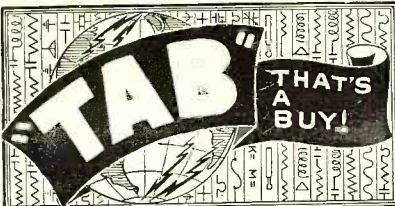

PHOTOFLASH KIT AIRCORPS 1503 NEW. Contains POWER SUPPLY, RECTIFIERS & CONDENSERS, 30mfd, TRANSFORMERS & Relay. 2 STROBOLAMPS 12 MILLION lumens light output. 15 to 30000 flashes & rctrs. FOR COLOR & BW film. READY for USE on 12VDC. IN ADDITION, KIT INCLUDES INSTRUCTIONS & PARTS TO CONVERT to 115VAC. SPECIAL "TAB" BUY. \$59.95 1503 SET plus 6x2V (12V) SBATYS..... 69.95  
PHOTOFLASH 1503 & BATYS & PCK for 115VAC/12VDC operation READY TO WORK. 119.00  
16mm/PAN/50 FILM Gun Camera 3 for \$1.  
Pan 32/10 Rolls \$1.98; Pan 50/74..... for 8.98

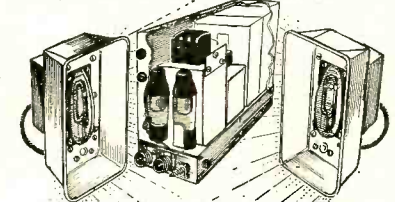

### NEW XTAL DIODES & THERMISTORS

IN34 \$1.08 @ 2 for \$2.10, 10 for \$9.85.	\$45.00
IN21 or IN23..... 3 for 1.00	
IN21A, 22, 23A..... 25 @ \$1..... 12 for 10.00	
IN23B..... @ \$2..... 10 for 17.50	
D 168391 Compensator @ \$2..... 3 for 5.00	
D170396 HF pwr meas @ 90c. 3 for 2.50	
IC + Bulb time delay @ 90c..... 3 for 2.50	
BOX KITE NYLON..... 2.95	
BALLONS J' & H' Gas..... 4.95	
GLYPTAL 4R..... .35	
DIRECTION INDICATOR & DRIVE Bendix & G..... 4.95	
BAT 3V/12ZBP Burgess..... 4 for 1.00	

### COLLINS ART13 SPEECH AMPLIFIER

Dynamic or Carbon Mike or Line inpt, Audio & Drive to PPG& Monitoring & osc tube. SPECIAL less tubes \$4.50  
SAME & CLIPPER KIT & TUBES & Data NEW..... \$8.25

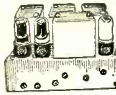

### BLOWERS

100CFM/28VACDC..... \$ 4.95	
SAME & Transf 115VAC..... 6.45	
125CFM/115VAC..... 8.95	
250CFM/28VACDC & Xformer 115VAC (cut)..... 10.95	
40CFM/28VACDC..... 3.25	
SAME & Transf 115V..... 4.25	
Pilot light 1/2" & bulb 115 VACDC..... 4.95	
KIT 1/2" & IW RSTRS..... 100 for 1.98	
KIT CONTROLS..... 10 for 2.00	
KIT SOCKETS..... 25 for 2.49	
KIT SILVER & MICA CAP..... 50 for 2.00	

### 1-198 SIGENERATOR NEW TEST Oscillator 7 to 15mc. Mhz.

Atntd with 1-10-100-2000/outpt & PWR SUP 115VAC & 3 tubes 37, 41 & 62L, National N Dial easy to add Ranges In HVY Metal Case..... \$14.95  
BC906/Montr & Fregmtr..... 29.95  
EC1066 RCVR 150-225mes. New..... \$7.95  
1-198 Sigenrtr 150-225 mes. New..... \$7.95



### KIT 866A'S

XFORMER INPUT 115VAC/50-60cy OUTPUT 2.5VCT/10 Amps 10KV insulation & Socket Ceramic SPECIAL \$5.95	
KIT 872A XFORMER INSLTD 12.5KV SOCKETS & TUBES \$12.95	

### VOLTAGE REGULATOR NEW RAYTHEON

95/130V, 60cy. Output 115V/60 Watt CSD. \$ 10.95	
198 to 242 Vmpt/50-60 cy. Output 220V/500 Watts/0-5% Regulation Rack mtg. 36.00	
SOLA VOLTAGE REGLTR Pk 95 to 190V 50-60cy/output 125 or 220V/2KW/17.4 Amps USN CONT Duty 1LN \$14.95 NEW 175.00	
STORAGE BATY BB52/36 Volt \$1.49 @ 8 for 10.00	
S'BATY BB206/2V/19A \$1.89 @ 6 for 10.00	
S'BATY BB54/27A \$1.98 @ 6 for 11.00	
WESTON 0-5ma 2 1/2" B'C tuning meter..... 1.98	
VARIAC 200B/0-115VAC/175 Watt..... 10.95	
VARIAC 200C/0-115VAC/180 Watt..... 15.95	
VARIAC 100R/115 or 230/230 or 270/2 KW 36.95	
LN Like New Used Good Guaranteed.	

"TAB" MONEY BACK GUARANTEE \$3. MIN. ORDER F.O.B. N.Y.C. ADD SHIPPING CHARGES & 25% DEPOSIT, C'TABOGRAM, WO 2-7230.

### RECTIFIERS BRIDGE

IN	OUT	AMPS	PRICE	IN	OUT	AMPS	PRICE
18V	14	1.35	\$2.49	64V	50	3.5	\$12.95
18V	14	3.5	3.49	64V	50	5	5.95
18V	14	5	4.85	90V	72	.150	2.85
36V	28	.320	1.49	90V	110	.150	2.95
In	Out	Amps	Price	In	Out	Amps	Price
36V	28	1.5	3.25	120V	110	150	2.85
36V	28	3.5	6.50	135V	116	3.5	16.95
36V	28	5	7.50	120V	150	10ma ea.	.49
64V	50	.220	2.89	135V	116	3.5	16.95
64V	50	1.5	3.19	210V	150	10ma ea.	.49

EACH, SPECIAL 1TAT/SELENIUM..... 3 for \$1.10  
6000mfd/15WV \$2.49; 500mfd/60WV..... 1.98  
2000mfd/30WV 1.98; 500mfd/200WV..... 1.49

### "TAB" Standard "JAN" Tubes

0A4G \$ 1.00 687 \$ 0.87 922 \$ 1.40	
024..... .85 68A7..... .54 923..... .49	
1B24..... 2.95 6SC7..... .71 931A..... 3.49	
1B27..... 2.95 6SG7..... .71 954..... .45	
1E7G..... .98 6SH7..... .72 955..... .45	
1L4..... .70 6SJ7..... .58 956..... .49	
1L6G..... 1.00 6SJ7G..... .58 957..... .49	
1L14..... 1.00 6SK7..... .58 958A..... .45	
1LN5..... 1.00 6SL7..... .87 991..... .35	
1P5G..... .79 6SN7..... .75 1613..... .69	
1P24..... 2.95 6SN7GT..... .75 1614..... 1.50	
1R4/1294..... 1.00 6SQ7..... .54 1616..... 1.87	
2AP1A..... 2.85 6SS7..... .71 1619..... 1.87	
2C26..... .38 6UGT..... .71 1622..... 1.49	
2C34/RK34..... 4.98 6U6T..... .58 1624..... .70	
2C40/446..... .73 6X4..... .53 1625..... .39	
2D21..... 1.20 6X5..... .53 1626..... .45	
2E22..... 1.45 6Y6G..... .88 1629..... .38	
2J21/725..... 12.49 6Z4/84..... 74 1635..... 1.90	
2J26..... 14.95 7B7F/1813..... 2.95 1639..... .75	
2J30..... 14.80 90Y..... 3.95 2050..... .88	
2J31..... 14.50 10J..... .59 2051..... .48	
2J32..... 16.95 12A6..... .34 7193..... .38	
2J33..... 14.50 12AH7..... .87 8005..... 3.25	
2J34..... 18.95 12AR7..... .95 8012..... 3.95	
2J49..... 35.00 12D7P..... 14.75 8013A..... 4.95	
2J55..... 24.95 12G7P..... 14.75 8020..... 4.95	
2K16A..... 39.95 12SA7..... .58 9001..... .49	
2K25..... 9.95 12SH7..... .71 9002..... .59	
2K29..... 6.95 12SK7..... .58 9003..... .49	
2V3G..... .98 12SQ7..... .58 9004..... .49	
2X2..... .70 12X3..... .90 9006..... .45	
3A4..... 7.0 15E..... 1.45 CG1..... 4.95	
3B7/1291..... .95 25Z5..... .65 CE206..... 3.95	
3B24..... .95 35L6..... .58 CE215..... 5.95	
3BP1..... 1.49 35Z5..... .45 CK1005..... .30	
3BP1A..... 2.95 37..... .78 F127A..... 12.00	
3C23..... 4.95 50L6..... .58 FG104..... 14.95	
3E29/829B..... 3.90 80..... .52 FG105..... 16.95	
3F2..... 2.98 83V..... .88 FG166..... 49.00	
3JP12..... 2.95 205B/VT2..... .98 434/7C29..... 7.90	
3S4..... .55 211..... .79 HK24/3C24..... 9.95	
4J47..... 35.00 215..... 2.95 RX215..... 9.95	
5AP1..... 2.75 250TH..... 19.49 T200..... 12.00	
5BP1..... 1.45 250TL..... .58 V60..... 14.95	
5B24..... 3.95 304T..... 5.95 VR92..... .45	
5CP1..... 2.95 304TL..... 1.98 VR105..... .74	
5D21..... 19.00 307A/RX95..... 3.75 VR150..... .74	
5FP7..... 3.95 388..... 2.95 WL468..... 9.95	
5HP1..... 3.95 393..... 5.95 WL530..... 49.50	
5T4..... 1.25 450TH..... 36.00 WL619..... 20.00	
5UG..... .87 527/1000S..... 65.00 UX6553..... 2.95	
5W4..... .87 631PI/SN4..... 3.75 TUNGAR*.....	
5Y3..... .38 703A..... 4.95 20X672*..... 2.95	
5Z4..... .88 707B/2K28..... 9.95 198698*..... 2.95	
6AB7..... .98 710A/8011..... 2.90 10W..... 3.95	
6AG7..... .72 717A..... 3.74 313/.....	
6AG5..... .88 722/287A..... 9.95 49**Box..... .60	
6AG7..... 1.05 728AB..... 6.95 64**Box..... .70	
6AJ5..... .98 726A..... 6.95 56/74**.....	
6AK5..... .69 802..... 1.95 Box..... 1.40	
6AL5..... 1.05 803..... 7.95 10W**..... .39	
6BG6..... 1.04 804..... 3.74 313/.....	
6B8G..... .98 805..... 3.74 313/.....	
6C4..... .39 807..... 1.24 28V**..... .10	
6C5..... .51 808..... 1.95 323/.....	
6C6..... .71 810..... 5.75 100**qty 10.00	
6C8G..... .98 811..... 1.95 10W.....	
6D4..... .59 813..... 2.98 4522/250W 1.49	
6D5..... .59 814..... 2.25 4560/.....	
6E5..... .71 815..... 1.15 60W..... 2.49	
6F6/1613..... .69 816..... .79 NEON BULB*.....	
6F8..... 1.04 826..... 3.75 NE21/100..... 4.50	
6G5/6U5..... .95 829B..... 2.75 NY.....	
6G6..... .86 832A..... 1.10 NE16T &.....	
6H60orM..... .54 836..... 2.25 991..... .25	
6J4..... 5.25 837..... 12.95 NE51T &.....	
6J5..... .49 WL632A..... 4.50 NE20/qty 6.00	
6J6..... .65 845..... 2.49 100.....	
6J7..... .70 860..... 19.95 SOCKETS.....	
6K6GT..... .86 861..... 5.95 2X2HV..... .30	
6K7..... .49 864..... 1.00 705/715..... .69	
6K8..... .36 868..... 1.00 803/304T..... .90	
6L6G..... 1.04 GL872A..... 3.75 807..... .24	
6L7..... .87 884..... .98 813..... .69	
6N7..... .87 918/CE1C..... 1.82 829/832..... .25	

TUBES GTD except open Fil. & breakage. Write Qty Prices.

### FREQMTR, WYEMTR & CONTROL UNIT

BC1162p/orC150 f req 150-210mcms ideal Unit Convert citizens band Radio 115V 60cy Pwr Supply with 19 tubes NEW..... \$25.95	
SAME less tubes (LT)..... 13.95	
Fregmtr&Wymtr only (LT)..... 8.95	
Power Supply only (LT)..... 6.95	
BC456 MODULATOR used LN..... 12.95	

ONE OF A SERIES



**BALANCE WEIGHTS**

**WHY BURLINGTON PANEL INSTRUMENTS PROVIDE UTMOST RELIABILITY...**

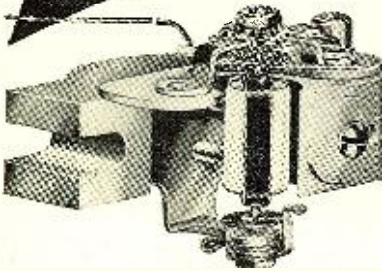

BALANCE WEIGHTS of helical type phosphor bronze, formed in a manner which eliminates slipping or shifting, are used to balance the moving element. All ranges AC and DC available in 2 1/2", 3 1/2", 4 1/2" rectangular or round case styles and are guaranteed for one year against defects in workmanship or materials. Refer inquiries to Dept. K98.

**Burlington INSTRUMENT COMPANY**  
BURLINGTON, IOWA

Full details on the new mechanism may be secured from *Crescent Industries, Inc.*, 3430 Milwaukee Avenue, Chicago 41, Illinois.

**MOBILE XMTR.**

*Suburban Radio Company* of East Rutherford, New Jersey has just introduced the "Subraco" MT-15X mobile transmitter which is sufficiently small to be mounted in the glove compartment of the average car.

The unit weighs only 6 pounds and measures 5 1/2 inches wide, 4 1/2 inches high, and 6 1/2 inches deep. A specially designed illuminated meter has three different scales to read all stages. All controls, including the crystal jack, are on the front panel within easy reach of the operator. The unit incorporates a built-in antenna change-

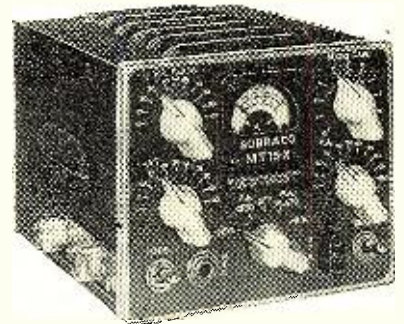

over relay. The high level class B modulator is capable of delivering 17 watts of audio.

Push-to-talk operation as well as a send switch for lengthy transmissions or tuning up is also included in the design.

Full details and price on the "Subraco" MT-15X may be secured from *Suburban Radio Company*, 83 Herman Street, East Rutherford, N. J. -50-

The winner! Harry L. Smith of Long Island City, New York, won the May award in the Hytron Radio & Electronics Corp. contest to discover new ideas for servicing tools. Mr. Smith won a DuMont Type 274 five-inch oscilloscope. Everett B. Boise, Hytron's commercial engineer in the New York area makes the presentation as Bill Harrison of Harrison Radio Corp. stands by to add his congratulations. There are five more monthly prizes to be awarded and servicemen are invited to enter the contest. The board of judges includes: Oliver Read, RADIO & TELEVISION NEWS; Sanford Cowan, Radio Service Dealer; W. W. MacDonald, Electronics; Joseph Roche, Radio Maintenance; J. L. Stoutenburgh, Radio & Television Retailing; and Lewis Winner, Service. See your Hytron jobber for entry blanks.



**RADIO & TELEVISION NEWS**

For the best...  
look west  
of the Rockies



**quality at a price**

Taking full advantage of the notably superior Altec Lansing design principles and engineering know-how, the new Peerless "20-20 Line" offers input, output, interstage, and special purpose transformers within price range that meets the realities of present-day manufacturing and replacement markets.

**The NEW Peerless "20-20 LINE" of Audio Transformers**

Transportation prepaid anywhere in the United States, on orders totaling 100 pounds or more. Write to Dept. U for new catalogue.

PEERLESS ELECTRICAL PRODUCTS DIV.  
6920 McKinley Ave., Los Angeles 1, Calif.  
Frazar & Hansen, Ltd., 301 Clay St., San Francisco 11,  
exclusive export agent



**6 C 4 TUBES—10c Ea.**

New—Guaranteed  
Limit 3 to a Customer

**ELECTROLYTIC CONDENSERS**

2x4500 Mfd. 2V.....	.55	50 Mfd. 100V. \$	.45
2x3000 Mfd. 3V.....	.75	2x40 Mfd. 150V.	.45
2x1250 Mfd. 10V.....	.75	500 Mfd. 200V.	.95
500 Mfd. 25V.....	.45	15-15-20 Mfd. 250V.	.45
2x 500 Mfd. 25V.....	.75	125 Mfd. 350V.	.45
2x3500 Mfd. 25V.....	.90	30 Mfd. 450V.	.35
25 Mfd. 50V.....	.35	2x 8 Mfd. 475V.	.60
100 Mfd. 50V.....	.45	2x19 Mfd. 575V.	.90

**OIL FILLED CONDENSERS**

2 Mfd. 400 VDC. \$	.30	2x8 Mfd. 600 VDC. \$	1.45
2x5 Mfd. 400 VDC.	.85	2 Mfd. 1000 VDC.	.70
.1 Mfd. 600 VDC.	.20	2x4 Mfd. 1000 VDC.	1.75
2x.25 Mfd. 600 VDC.	.35	10 Mfd. 1000 VDC.	1.95
5 Mfd. 600 VDC.	.70	15 Mfd. 1000 VDC.	2.25
7 Mfd. 600 VDC.	.75	5 Mfd. 1800 VDC.	2.25
8 Mfd. 600 VDC.	.80	2 Mfd. 4000 VDC.	4.50
10 Mfd. 600 VDC.	.85	4 Mfd. 4000 VDC.	7.95
3x4 Mfd. 600 VDC.	1.45	.1 Mfd. 7500 VDC.	1.25
4x3 Mfd. 600 VDC.	1.45	.25 Mfd. 20 KVDC.	24.50

**VARIABLE CONDENSERS**

(Maximum Ratings Per Section)

Single Sec. 18 Mmfd. 3500 V.—Cardwell	.....	\$1.45
Single Sec. 18 Mmfd. 5000 V.—Bud	.....	1.75
Dual Sec. 20 Mmfd. 5000 V.—Bud	.....	2.95
Dual Sec. 25 Mmfd. 3000 V.—Johnson	.....	1.45
Single Sec. 28 Mmfd. 2000 V.—Hammerlund	.....	.69
Single Sec. 35 Mmfd. 2000 V.—Hammerlund	.....	.69
Dual Sec. 75 Mmfd. 1000 V.—Bud	.....	1.25
Dual Sec. 80 Mmfd. 5000 V.—Bud	.....	3.25
Dual Sec. 100 Mmfd. 3000 V.—Johnson	.....	3.45
Single Sec. 110 Mmfd. 3500 V.—Cardwell	.....	1.75
Triple Sec. 160 Mmfd. W/Air Trimmers—Cardwell	.....	2.25
Single Sec. 170 Mmfd. 1000 V.—Bud	.....	1.20
Triple Sec. 195 Mmfd. 1000 V.	.....	1.95
Dual Sec. 200 Mmfd. 2000 V.—Bud	.....	3.75
Dual Sec. 300 Mmfd. 1750 V.—G.E.	.....	3.75
Triple Sec. 399 Mmfd. 1000 V.	.....	2.25
Triple Sec. 493 Mmfd. 1000 V.	.....	2.25

**MISCELLANEOUS**

300 Ohm Twin Lead.....	per ft. \$	.025
73 Ohm Coax Cable RG59/U.....	per ft.	.055
Swinging Choke 9-36 Hy. @ 75/075 A.....		14.95
Relay, 115 VAC—DPDT—30 Amp. Contacts.....		3.25
Deflection Coil for 7" C.R. Tube.....		2.75
Mica Condenser .1 Mfd. @ 600 V.D.C.....		1.45
100 Insulated Resistors—1/2 & 1 W. Ass't'd.....		1.45
110 V. Line Filter 2 Amp.....		.35
Blocking Oscillator Transformer (Wemco).....		.45
3 Cm. Adjustable Impedance Transformer.....		12.50
Hookup Wire—Ass't'd Lengths & Colors W/Tinned Ends.....	Approx. 500 ft.	1.45
4A Fuse Extractor Post (Ideal Crystal Diode Holder).....		.15

15% Discount on Orders of \$25.00 or More  
Min. Mail Order \$2.00—25% Dep. with order. Bal. C.O.D.  
WRITE YOUR NEEDS

**MARCO ELECTRONICS, INC.**

513-515 W. Franklin St. Baltimore 1, Md.  
Lexington 0198

**LOW  
FACTORY  
PRICES!**

*... on the Sensationally NEW 1949*  
**MIDWEST RADIOS**

**NEW**  
**SERIES 16**  
**SUPER DE LUXE**  
**AM-FM**  
**CHASSIS**

**30 DAYS TRIAL**

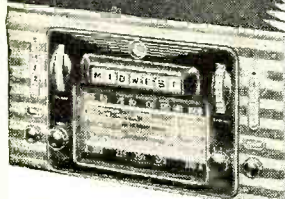

Here is the last word in radio engineering . . . a powerful, world-ranging, magnificently-toned radio that is unsurpassed for performance, selectivity, sensitivity, and advanced engineering features. Uses these latest-type tubes, rectifier and tuning indicator: three 7A7, three 7A4, two 7C5, one 7A6, one 7Q7, one 6BA6, one 6BE6, one 6C4, one 6AL5, one 5U4, one 6U5. Comes complete with satin stripe copper finish front panel attached, Magna-Tenna Loop Aerial and giant 14½" Electro-Dynamic Panasonic Speaker. Requires only a few minutes to install, plug in and play. **LOW FACTORY PRICES . . . EASY TERMS . . . 30 DAYS TRIAL.** Send TODAY for FREE 1949 Midwest Radio Catalog of separate Chassis and beautiful Console and Table models.

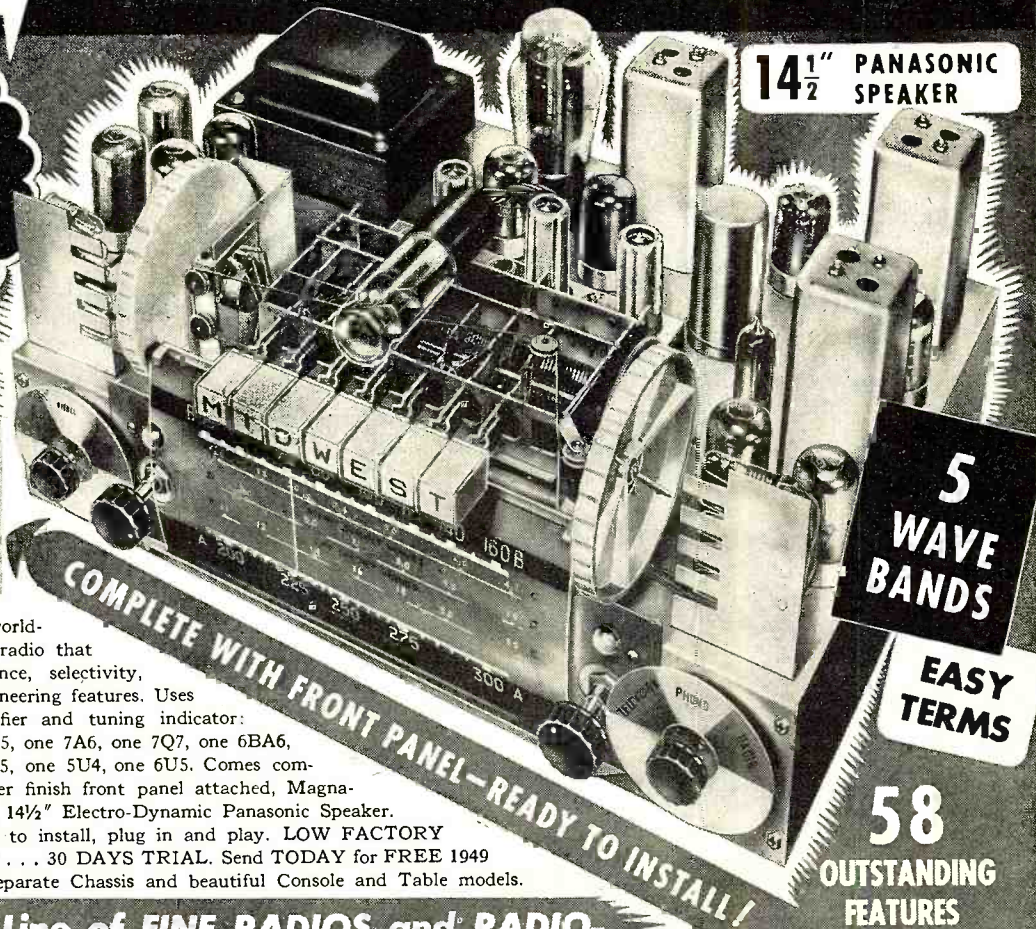

**14½" PANASONIC  
SPEAKER**

**5  
WAVE  
BANDS**

**EASY  
TERMS**

**58**

**OUTSTANDING  
FEATURES**

- Including the Exclusive Midwest
- FLASH-O-MATIC Volume and Band Indication
- TELEVISION Audio Switch-Over
- FIDEL-A-STAT Color-Ray Tone Selection
- TRI-MAGNADYNE Coil System
- ...Plus NO-DRIFT FM and many other features

**A Complete Line of FINE RADIOS and RADIO-PHONOGRAPHS . . . Available in SEPARATE CHASSIS Like the POWERFUL SERIES 16 AM-FM Model above or in COMPLETE CONSOLES like this...**



**Beautiful  
SYMPHONY GRAND  
AM-FM Radio-Phonograph with  
TELEVISION Audio Switch-Over  
and NEW Intermix AUTOMATIC  
RECORD CHANGER**

A Magnificent musical instrument and a masterpiece of cabinet design—the finest Midwest Radio in 29 years of manufacture. Offers world-ranging radio reception and newest automatic Intermix Record Changing Phonograph. Uses Series 16 Super DeLuxe AM-FM Chassis. Giant 14½" Panasonic Speaker; Tri-Magnadyne Coil System; Built-In Loop Antenna. Other luxurious console and table model cabinets available with Series 16, 12, and 8 chassis—on Easy Terms and 30 Days Free Trial.

*Rush for Free Catalog!*

**FILL IN COUPON AND MAIL TODAY OR JUST SEND NAME AND ADDRESS ON 1c POSTCARD**

**MIDWEST RADIO & TELEVISION CORP.**  
Dept. 372 909 Broadway, Cincinnati 2, Ohio  
Please send me your new FREE 1949 Catalog.

NAME .....

ADDRESS .....

CITY ..... ZONE ..... STATE .....

**BUY DIRECT FROM FACTORY and SAVE!**

**MIDWEST RADIO & TELEVISION CORP.**

Dept. 372 909 Broadway, CINCINNATI 2, OHIO

# WAR SURPLUS BARGAINS ORDER BY MAIL FROM ABELL!

## MINE DETECTOR SCR 625

Ideal for locating buried metal, pipes, treasure, metallic fragments in lumber. Approximate depth of detection 6 feet depending on soil conditions. Supplied with batteries and tubes. Schematic. Tested before shipment. Shipping weight, 70 lbs. **\$49.50**



## MACKAY RADIO LIFEBOAT TRANSMITTER—TYPE 148-B

5 Watt Output 500 KC A2 1000 cycle emission. Fully automatic in operation. Transmits either, SOS or SSS signal; or can be keyed manually. Equipment contained in watertight carrying case. Everything supplied except for 6 V battery which is all that is required for power. Lightweight, compact, durable. Slightly used **\$18.95**

## EE-8 FIELD PHONES

Small portable 2-wire telephone. Generator, bell handset, etc. Excellent for farms, contractors, mines, etc. Requires only 2 flashlight batteries. Tested before shipment. Each \$9.75. Pair \$17.95

## 100 WATT AM TRANSMITTER (BC 375 or BC 191)

Frequency Range 200-500 KC and 1500-18,000 KC. Can be modified to operate on 10 and 20 meters. Self-excited oscillator, temperature controlled. PA neutralized 211 operating Class "C". Pair of 211's as Class "B" modulator. Versatile antenna matching network built in. Meters—0-350 MA, 0-8 Amps RF and 0-15 V. Fine business for your medium power rig. Use as is or take apart for hundreds of top quality parts. BC 375 with tubes and tuning unit **\$15.95** BC 191 with tubes, 2 tuning units, connecting plugs, dummy load, and 12 V dynamotor power supply **\$24.95**

## BC-603 FM Tank Receiver and BC-604 FM Tank Transmitter

Range 20 to 29 MC, 30 KC deviation. Manual tuning or push-buttons. Receiver has 10 tubes, speaker, BFO and Call signal. Transmitter has 8 tubes, including 1624 output tube capable of 20 watts RF. Output meter and grid metering included. Phase modulated. Your choice of either 603 or 604 w/schematic **\$15.95** or both for **\$29.95**

Satisfaction guaranteed. Order by Mail. We ship C.O.D. Order today. Prices subject to change without notice.

## COAX AND CABLE

RG8/U, 52 ohm, .405" OD. For antennas, matching sections, etc. 25' or over **5c per ft.** 250' or over **4 1/2c per ft.** RG29/U, 53.5 ohm, .184" OD. Small size. For signal generators, lead ins, connecting cables. 25' or over **4c per ft.** 250' or over **3 1/2c per ft.** RG39/U, 74 ohm, .310" OD. For RF coupling, patching cords. 25' or over **4c per ft.** 250' or over **3 1/2c per ft.**

## 7 CONDUCTOR CABLE #14 STRANDED

600 V insulation. Heavy duty rubber covered. 65 feet long. Russell-Stoll plug #3880 at each end. 7/8" OD. **\$4.95**

## 3 CONDUCTOR CABLE #18 STRANDED

400 V insulation. Heavy Duty rubber covered. 250 feet long 1 Cond. Shielded. Plug each end **\$6.95** Heinemann Circuit Breakers, Single Pole 115 VAC. Choice of 1.5, 5, 7, 10, 12, 15, 30 or 35 amps. **\$1.95**



## 1-138A—SIGNAL GENERATOR

2600 to 2900 mc. Uses variable cavity resonator with lighthouse triode as oscillator. Features built in attenuator, delay line, output indicator, output control and phasing control. 3" meter 0-200 microamp mounted in front panel. Tubes 6AG7, 2-6AC7, 2C40. Separate compact regulated power supply delivers 275 to 375 VDC at 60 MA. This power supply alone worth twice our asking price. Tubes \$14, 2A3, 6AT7, 6X5, WE 313CC. Both oscillator and power supply can be removed and installed in 19" rack—Schematic. **\$29.95**

## WIRE GRIPS (COMALONGS)

SMALL **\$1.50**  
MEDIUM **\$2.50**  
LARGE **\$3.50**

SCR-522 VHF Transceiver—100 to 156 MC. Crystal controlled. 17 Tubes **\$22.95**

## ELECTRIC MOTOR

1/20 HP Motor. Split Phase **\$10.95**  
Cap. start **\$11.95**  
1/4 HP Motor. Split Phase **\$14.75**  
Cap. start **\$15.95**

## ROPE

ROPE—3/4" SISAL  
Minimum order—15'  
Max. length—150'

## ANTENNA TRIPOD

13 ft. high; strong. Weather-proofed head rotates on ball bearings. Will clamp two inch tube or shaft. Legs are 2" phenolic tubing, with foot-proof lock joints for assembly. Fine business for rotating beams. TV. No guying or RF insulation needed. Weight, 75 lbs. Brand New **\$10.95**  
See May ad for photo

## BC-221 FREQUENCY METER

A heterodyne frequency meter comp. w/ tubes, crystal, calibration chart. Range is 125KC to 20 MC. Can be used with 110 Volts AC power pack, batteries or vibrator. Makes a fine signal generator or converts to VFC. These are slightly used. Tested before shipment **\$37.75**

## LINEMAN'S POLE CLIMBERS AND STRAPS

LINEMAN'S BELTS AND SAFETY STRAP. State belt size. **\$5.75**

## AUTO TRANSFORMERS 300 WATT—FULLY ENCLOSED

115/160/170/180 Volts or 115/140/150/160 Volts. State Voltage range **\$2.95**

## ANTENNA SWITCHING RELAY UNIT—BC-442

0-10 Amp., R.F. meter. 50 mfm. 5 KV vacuum capacitor. 24 Volt Relay **\$1.95**

## DESK STAND MICROPHONE

With switch, 6 ft. cord and plug, 200 ohm carbon button. **\$2.95**

## ROTARY BEAM GEAR BOX

Gear train, motor mounts, enclosed in a waterproof housing. Excellent for use in constructing your new beam. Brass gears, bearings, useful hardware. Plenty of room for motor, selsyn and controls. 1 1/2 x 14 x 9". Two waterproof junction boxes also included. NEW, ridiculously low **\$5.95**

## MAST BASE, MP-19

Suivel stud. Fits MS-44 mast section. 1 3/4" D x 4" L stud. Mounting centers 4 3/4" **\$1.25**

## 24 FT. ANTENNA WHIP

8 Screw-in sections, tubular copper-plated steel, with insulated mounting base. Our Price **\$9.95**

## CHECK BULLETINS DESIRED:

- Transformers
- Power Units
- Insulators
- Fuses  Cable
- Sporting Goods
- Clothing & Miscellaneous
- Pole Line Equipment
- Photographic Equipment
- Test Equipment

We will gladly prepare a bulletin on any items you may desire. We have hundreds of items. Hundreds of bargains.



**AUTOMATIC M-86 AUTO RADIO**

- Six Tube Superheterodyne
- Three Gang Condenser
- Powerful, Long-Distance Reception
- Fits All Cars, Easy Installation
- Mounting Brackets Included. Net **\$27.97**

**MAIL US YOUR ORDERS**

All orders filled within 24 hours  
Illustrated parts list on request  
Sylvania and Cunningham tubes 50% off list

**Bill Sutton's** Wholesale Electronics  
Fifth at Commerce Fort Worth, Texas

**COMPLETE RADIO HANDBOOK**  
**The RADIO DATA BOOK**

the only radio handbook of its kind... 118 pages... 12 sections... each covering a radio subject more completely than any other book!

ANYONE and everyone in radio and electronics can use this book!

Section 1. The 150 Basic Circuits in Radio  
Section 2. Complete Test Equipment Data  
Section 3. Testing, Measuring and Alignment  
Section 4. All about Antennas  
Section 5. Sound Systems  
Section 6. Recording  
Section 7. Complete Tube Manual  
Section 8. Charts, Graphs and Curves  
Section 9. Codes, Symbols and Standards  
Section 10. 50 Tested Circuits Designed for Optimum Performance  
Section 11. Dictionary of Radio and Electronic Terms  
Over 1000 illustrations! Less than 42c a book!

Order from your jobber, or from address below.

**\$5.00** **MONTCLAIR 1, NEW JERSEY**  
BOLAND & BOYCE INC., PUBLISHERS

## Spot Radio News (Continued from page 20)

Others who testified included A. Earl Cullum, Jr., consulting engineer, representing WHDH, Boston; Joseph Waldschmidt, consulting engineer for the Yankee network; G. W. Ray WNHC-TV consulting engineer; George C. Davis, WJNO, West Palm Beach, and WIND, Chicago, consultant; Dr. Thomas T. Goldsmith, DuMont's director of research, who discussed WTTG's coverage, and scores of others.

The volumes of testimony will involve weeks and weeks of study by FCC. A decision will probably be ready in the early fall, perhaps after the September 20 hearings on the possible use of the u.h.f. bands for television.

**AS PREDICTED**, no radio legislation was enacted by the 80th Congress. The much debated Lemke, Johnson, and White bills were still in the committee stages when Congress adjourned. Consensus was that the Lemke measure, which would have returned the 42 to 50 mc. band to FM, might reappear at the next session in the same or similar form. The White and Johnson bills, which would have granted program review powers to FCC and banned broadcast station powers above 50 kw., were deemed so important that Senator Wallace H. White announced appointment of a three-man subcommittee to study communications problems, including features of his bill, during the Congressional recess. The committee, functioning as a panel of the powerful Senate Interstate and Foreign Commerce Committee, which probes radio legislation, will be chairmanned by Senator White, who will work with Senators Tobey and McFarland. According to the Senator White order, the committee will consider, specifically, the manner in which the FCC has been exercising its licensing authority, extent to which the commission examines the qualifications of applicants for renewals or new licenses, problems arising from unprecedented demands for frequencies for safety and special services and common carrier uses, including new industrial uses, aviation, railroads, busses, trucks, taxicabs, etc.

A special House committee was also appointed to investigate the policies and licensing practices of the FCC. Rep. Harness was named chairman of this committee. Assisting will be Reps. Hall, Elston, Priest, and Harris.

Five years ago, the FCC was also the subject of an intensive investigation which lasted many, many months.

**A NEW INDUSTRIAL MOBILIZATION PLAN** to provide equitable distribution of an anticipated billion dollars of military contracts among manufacturers, and accelerated production, has been set up by RMA. The



program is being guided by a special policy committee who have suggested to the military that the services centralize and coordinate the procurement of radio and electronic equipment and components by placing all purchase contracts under the direction of a four-man committee composed of representatives of each of the three services—Army, Navy, and Air Forces—and one civilian industry representative.

The new committee, which replaces the government liaison committee which was headed by Fred Lack and included Frank Folsom and W. A. MacDonald, went into action on the first of July, requested immediate revision of government procurement policies before the government rearmament contracts were let.

Broadcasters are also playing a prominent role in the mobilization plan, with many oldtimers having been asked to serve on committees of the Office of Civil Defense Planning. Experts on the broadcasting group include J. Harold Ryan, former NAB president and wartime assistant director of censorship; Everett L. Dillard, president of the FM Association; Jack Poppele, president of TBA and chief engineer of WOR; and Capt. William C. Eddy of WBKB, a TV station in Chicago.

According to present plans, the group would cooperate with the FCC, State Department, Signal Corps, Navy Communications, Air Force, and Research and Development Board.

OCDP is headed by Russell J. Hopley, who is president of the *Northwestern Bell Telephone Company*, and is now on leave. Communications activities of OCDP are under the direction of Herbert J. Schroll, assistant to the vice president of the *New York Telephone Company*.

**THE NORTH AMERICAN** Regional Broadcasting Conference scheduled to begin in August in Montreal has been postponed.

In a memorandum to ye correspondent, Francis Colt de Wolf, chief of the Telecommunications Division of the Department of State, said: "It has been necessary to postpone the proposed conference for approximately one year because of the need to reach certain domestic decisions, particularly in the matter of clear channels, before the proposals for the Montreal Conference could be drafted. This government has suggested to the other countries party to the North American Regional Broadcasting Agreement that the conference be postponed and the terms of the currently effective NARBA be extended. A number of the countries have indicated their acceptance of the proposal, but all have not yet done so. It is certain, however, that the United States cannot attend the proposed conference in Montreal in August."

The clear-channel project had received quite a bit of tossing about in the Senate, with Senator Johnson in-

Why Your RAYTHEON Tube Distributor\* Recommends

## The New RAYTHEON BANTAL TUBE



### It's Easier to STOCK

At the same price as ordinary tubes one Raytheon Bantal takes the place of two—cuts your stock problem in half! The Bantal 12SK7GT, for ex-

ample, replaces, without shielding, either the GT or metal equivalent. Fast turnover, less money tied up in stock, more profit on your investment.

### It's Easier to SELL

All these advantages at NO EXTRA COST

**Rugged Eight-Pillar Construction** — Short pillars direct to elements: low grid-plate capacitance — greater stability.

**Completely Shielded Internally** — No external shielding hardware or installation labor. Increases your service profit.

**Glass Button Stem** — Low Loss.

**Glass-To-Glass Seal** — Permanent Vacuum.

**Wide Lead Spacing** — No Electrical Leakage.

**Strong Non-Flexible Leads** — No Base Shorts.

**Glass-Tc-Dumet Vacuum Seal** — No Air Leaks.

**EIGHT POPULAR TYPES** — 6SA7GT — 6SJ7GT — 6SK7GT — 6SQ7GT — 12SA7GT — 12SJ7GT — 12SK7GT — 12SQ7GT.

**SUPERIOR FOR HEAVY DUTY SERVICE** — Recommend Raytheon Bantals particularly for replacements in sets or equipments requiring tubes of long life and greater dependability. Their superior performance assures customer satisfaction and repeat business.



\*Your Raytheon Distributor sponsors the famous Bonded Dealer-Service Program. Ask him for full details on this business building plan.

RAYTHEON MANUFACTURING COMPANY

RADIO RECEIVING TUBE DIVISION

NEWTON, MASSACHUSETTS • CHICAGO, ILLINOIS • LOS ANGELES, CALIFORNIA

RADIO RECEIVING TUBES • SUBMINIATURE TUBES • SPECIAL PURPOSE TUBES • MICROWAVE TUBES

# SAVE

## Brand New and Fully Guaranteed

### SYNCHROS

- 1F Special Repeater, 115 volts, 400 cycle.  
Will operate on 60 cycle at reduced voltage. **Price \$15.00 each net.**
- 2J1G1 Control Transformer, 115 volts, 400 cycle. **Price \$2.00 each net.**
- 5G Generator, 115 volts, 60 cycle. **Price \$25.00 each net.**
- 5SG Generator, 115 volts, 400 cycle. **Price \$12.50 each net.**

### VIBRATOR

- 3H6694-11 Rauland Corporation, 6, 12 or 24 volt operation, 200 cycle. **Price \$2.75 each net.**

### PIONEER AUTOSYNS

- AY1, 26 volts, 400 cycle. **Price \$3.50 each net.**
- AY20, 26 volts, 400 cycle. **Price \$5.00 each net.**
- AY30, 26 volts, 400 cycle. **Price \$10.00 each net.**

### PIONEER PRECISION AUTOSYNS

- AY101D, new with calibration curve. **Price—Call or Write.**
- AY131D, new with calibration curve. **Price—Call or Write.**

### D.C. SELSYN SYSTEM

- G.E. 8TJ9 Position Transmitter & 8DJ11 Indicator, 24 V. D.C. dial calibrated to 0-360°. Ideal for ham beam antenna position indicator. **Price \$9.00 per set.**
- With Resistor & Rectifier. For 110 V. A.C. operation. **Price \$10.50 per set.**

Write for Complete Listing

**NOTE OUR NEW ADDRESS AND TELEPHONE!**

### D.C. ALNICO FIELD MOTORS

- 5069600, Delco, 27.5 V., 250 R. P. M. **Price \$4.00 each net.**
- 5069370, Delco, 27.5 V., 10,000 R. P. M. **Price \$4.50 each net.**
- 5069466, Delco, 27.5 V., 10,000 R. P. M. **Price \$2.50 each net.**
- 5068571, Delco, 27.5 V., 10,000 R. P. M. **Price \$3.65 each net.**
- SS-FD6, Diehl, 27.5 V., 10,000 R. P. M. **Price \$2.65 each net.**

### D. C. SERIES MOTORS

- C-2A-1B, John Oster, 27 V., 7,000 R. P. M. .7 amps., 1/100 H. P. **Price \$3.75 each net.**
- C-28P-1A, John Oster, 27 V., 7,000 R. P. M. .7 amps., 1/100 H. P. **Price \$3.75 each net.**

### D. C. SHUNT MOTOR

- 5066665, Delco, Reversible, 27.5 V., 4000 R. P. M. Flange mounted. **Price \$4.50 each net.**

### A. C. MOTORS

- 5069625, Delco, Constant Speed, 27.5 V. A. C. or D. C., 120 R. P. M. Has built-in reduction gears and governor. **Price \$4.25 each net.**
- 5071930, Delco, 115 V., 60 cycle, 7,000 R. P. M. **Price \$3.75 each net.**
- 36228, Hayden Timing Motor, 115 V., 60 cycle, 1 R. P. M. **Price \$2.75 each net.**
- Two-phase low-inertia motors, Pioneer, Diehl and Minneapolis-Honeywell. **Price—Call or Write.**

roducing his famous bill which would curb high power, with 50 kilowatts being the highest power available for clear-channel work. This action was the first step in causing the NARBA postponement. Introduction of the Johnson proposal in the White bill was the next. FCC then was told they could process a clear-channel decision, provided the maximum 50 kw. power ratings were retained until a new NARBA is set up. At that time, according to the Senate Interstate and Foreign Commerce Committee report, "it is hoped that the question of power can be equitably settled among all the signatories so that the use of power for radio stations will be uniform and fair among the countries of North America."

**A NEW RMA-IRE** eight-man joint technical committee to advise FCC and other professional and industrial groups has been formed, with Philip F. Siling, chief engineer of the *RCA Frequency Bureau* in Washington, as chairman. He will represent IRE, while Don Fink will represent RMA, and serve as vice-chairman.

The formation of JTAC follows a suggestion of FCC Chairman Wayne Coy that the industry provide FCC with authoritative technical information on the adaptability of frequencies above 216 mc. for telecasting. Data that the group will compile will be offered at the Sept. 20 u.h.f. TV-allocation hearings.

Other members of JTAC, which supplants the Radio Technical Planning Board (RTPB), include Dr. Ralph Bown of *Bell Telephone Labs*, Melville Eastham of *General Radio*, John V. L. Hogan of *Interstate Broadcasting Company*, former FCC Commissioner E. K. Jett who is now director of the *Baltimore Sun's* radio and television operations, Haraden Pratt of *Mackay Radio and Telegraph Corp.*, and David B. Smith of *Philco Corp.*, all of whom will serve for two years.

**THE SEVEN-MEMBER FCC** is now graced with feminine charm and beauty—Miss Frieda B. Hennock—who won the approval of Congressional committees and became Madame Commissioner in the final hours of the 80th Congress. The first woman to serve on the commission, and the first of her sex to sit on a government body regulating communications, Miss Hennock will serve for seven years, until June 30, 1955. As Miss Hennock was being sworn in, FCC Chairman Wayne Coy commented that the FCC has had . . . "rectitude, fortitude, solemnity, but never before pulchritude."

Good luck, Madame Commissioner.

**RETIRED FCC COMMISSIONER** Clifford J. Durr, whom Miss Hennock succeeded, was feted at an honorary luncheon given by the National Lawyer's Guild in Washington, D. C.

Guests included Senator Claude Pepper, former Assistant Attorney General Thurman Arnold, Supreme Court

**RADIO & TELEVISION NEWS**

# INSTRUMENT ASSOCIATES

147-57 41st AVENUE - FLUSHING, N. Y.  
Telephone INdependence 3-1919

## GREYLOCK

A Dependable Name in  
**RADIO TUBES**

GT, Glass, and Miniature Types

ALL TUBES IN INDIVIDUAL CARTONS

39c	39c	39c	49c	49c	49c	59c
6A8GT	12A76	25L6GT	1R5	6AK5	6X4	6L6GA
6K7GT	12BE6	25Z6GT	1T4	6AC5	25Z5	6U5
6Q7GT	12BE6	35W4	1U4	6AQ5	6A7	4J5
6SA7GT	12K7GT	45	1S5	6BE5	6C6	70L7
6SK7GT	12Q7GT	46	354	6BA6	6D6	84
6SQ7GT	12SA7	47	3Q4	6AU6	75	117L7
6V6GT	12SK7	50B5	3V4	6BJ6	117Z3	32L7
12A8GT	12SQ7	50L6				

Webster A11 Pickup, plastic arm. . . . . \$1.49  
TERMS: Net C.O.D. No order accepted for less than \$5.00

Write for Bargain Catalog N-9

**GREYLOCK ELECTRONIC SUPPLY CO.**  
30 CHURCH STREET NEW YORK 7, N. Y.



## RADIO COURSES

Preparatory, Broadcast, Marine Operating, Servicing, Aeronautical, Television, Frequency Modulation, Radar.

Classes forming for fall term Oct. 1.  
Entrance examination Sept. 20.

Veteran Training. Literature.

**COMMERCIAL RADIO INSTITUTE**  
(Founded 1920)  
38 W. Biddle St. Baltimore 1, Md.

# MORE VALUE! ... that's why more and more tubes are bought at SENCO!

HERE is value — Plus! With each and every purchase, you are assured of the best — GUARANTEED — merchandise at phenomenally low prices. Compare our tube list now and prove to yourself that only SENCO gives you these values!

## COMPARE OUR PRICES!

Type	Lots of 10		Type	Lots of 10	
	Each	Each		Each	Each
OZ4	69c	59c	6V6GT/G	45c	39c
1A3	45	39	6X5GT/G	49	39
1A5GT/G	59	49	7A4	53	43
1A7GT/G	55	45	7A7	59	49
1H5GT/G	59	49	7B6	44	35
1L4	49	45	7F7	49	44
1LA4	49	39	7N7	49	44
1LH4	69	59	7X7		
1LN5	69	59	(XXFM)	44	35
1N5GT/G	59	49	7Y4	44	35
1R5	55	49	12A6	29	25
1S5	59	55	12A8GT	35	28
1T4	69	55	12A16	50	45
1TSGT	59	49	12A17	69	59
1U5	36	30	12BA6	50	45
1V	45	39	12BE6	50	45
2A5	54	43	12F5GT	35	27
2A6	45	35	12H6	39	34
2A7	49	39	12J5GT	25	19
2X2/879	35	29	12J7GT	45	39
3A4	49	39	12K7GT	45	39
3S4	55	45	12K8Y	35	25
5U4G	50	40	12Q7GT	45	39
5W4GT	39	34	12S47GT/G	40	32
5X4G	39	35	12S7	35	32
5Y3G	42	37	12SC7/1634	49	39
5Y3GT/G	40	33	12SG7	43	37
5Y4G	39	32	12SJ7GT	55	49
5Z3	49	39	12SK7GT/G	45	35
5Z4	59	49	12SL7	49	43
6A7	50	45	12SQ7GT/G	40	32
6A8GT	49	39	12SR7	35	32
6AB7/1853	53	46	14A7	65	55
6AC5	69	59	14B6	59	49
6AC7/1852	65	60	24A	49	39
6AG7/6AK7	89	79	25A6	69	59

### ALL BRAND NEW!

Nobody Has This Tube At This Price

#### 350B — R.F. TETRODE

Fil. Voltage 6.3  
 Fil. Amp. 1.6  
 Plate Voltage (Max.) 600  
 Plate Current (Max.) 125  
 Screen Voltage 430  
 Diss. Plate 30W

only 79c ea

### COMPARE OUR PRICES! THOUSANDS OF TUBES! INDIVIDUALLY CARTONED!

#### RK34/2C34—R.F. AMPLIFIER-TWIN TRIODE

Fil. Voltage 6.3  
 Fil. Amps. 0.8  
 Plate Volts (Max.) 300  
 Plate Current (Max.) 80

Diss. Plate 10W  
 Grid Drive 1.8W  
 Power Out. 16W  
 Useful at full ratings to 250 MC

While They Last 29c ea.

### HERE'S A SENCO SCOOP

#### 836A/3B27 HALF-WAVE HIGH-VACUUM RECTIFIER

Voltage 2.5 A.C. volts  
 Current 5.0 amp.  
 Has two separate cathodes each of which is connected to its respective heater.

New Low Price 49c ea.

### DIVIDEND OF THE MONTH

2C26—U.H.F. Triode, Pulsed Oscillator Tube, 19c ea.  
 306A—Pentode R.F. Amplifier 19c ea.  
 7193/2C22—U.H.F. Triode Class A. Amplifier 19c ea.  
 Special—Any of these tubes 6 for \$1.00

### IMMEDIATE DELIVERY on all items

### HERE IS THE TUBE YOU'VE BEEN WAITING FOR

Especially for Wave Lengths between .5 Meter and 5 Meters A.F. Amplifier Detector, RF Power Amplifier and Oscillator — Class C.

#### 955 ACORN TYPE

only 19c ea.

### VT 52/45 SPECIAL CLASS A TRIODE

10 for \$1.00  
 Minimum Quantity 10

### E1148 TRIODE

Max. Plate Diss. 35  
 Fil. Voltage 6.3  
 Fil. Amps. .175  
 Amp. Factor 20  
 Max. Plate Volts 300  
 Max. Plate Cur. MA. 2C  
 Current MA. 4  
 DON'T WAIT  
 Only 39c ea.

A TUBE THAT ALL AMATEURS WANT  
**801A-R.F. Power Amplifier, Modulator**  
 Now 89c ea

### TRANSMITTING TUBES AT RIDICULOUSLY LOW PRICE

**830B**  
 R-F POWER AMPLIFIER, OSCILLATOR, CLASS B MODULATOR  
 Your Cost \$3.95

### R.M.A. GUARANTEE

### LOOK AT THIS SENCO VALUE TUNING INDICATOR TUBE

Heater 12.6V., .15 Amp.  
 Other Characteristics Same As 6ES  
 Special Price 19c ea.

### FOR THIS MONTH ONLY

**803 R-F POWER AMPLIFIER PENTODE**  
 Only \$5.95 ea.

### 1626 TRANSMITTING TRIODE

For oscillator applications requiring unusually stable characteristics R.F. Power Amplifier and Oscillator — Class C-Telegraphy

For This Month 14c ea.

### 8011 - VT90 MICRO PUP

Used as a C.W. Oscillator from 2 meters and up.

Now 59c ea

### 58P1 — High Vacuum Cathode Ray Tube

Electrostatic-Deflection  
 Fluorescence-Green  
 Max. Overall Length 17 1/8 inches  
 Heater Potential Length 17 1/8 inches  
 Max. Anode No. Potential Volts 2200  
 Stock a few for your scope \$1.19 ea.

## COMPARE OUR PRICES!

6AK5	74	69	25L6GT/G	49	39
6B7	55	49	25Z5	49	45
6B6G	79	69	25Z6GT/G	45	39
6B7J6	69	59	26	45	32
6C4	29	25	27	49	44
6C5GT	40	35	32L7GT	52	48
6C5MG	89	79	35/51	42	32
6C6	45	32	35L6GT/G	45	39
6C8G	37	29	35W4	43	40
6D6	49	45	35Y4	43	40
6F5	55	45	35Z3	44	35
6F6GT	45	39	35Z5GT/G	43	39
6F7/VT10	49	39	36	35	29
6H6GT/G	45	39	39/44	25	19
6J5GT/G	45	39	41	49	45
6J6	59	49	42	47	41
6P5GT	59	49	43	54	47
6J7GT	42	38	45	49	39
6K6GT/G	45	39	45Z5GT	59	49
6K7G	50	41	47	49	39
6K7GT/G	49	39	50A5	60	55
6K8G	55	49	50B5	42	32
6L6G	79	69	50L6GT	50	45
6Q7GT	47	39	50Y6GT	50	45
6R7	55	45	56	55	45
6R7GT	59	49	57	45	39
6SA7	49	39	58	45	39
6SA7GT/G	44	37	71A	39	29
6S87	55	45	75	50	39
6SD7GT	39	34	76	49	45
6SF5	49	39	77	35	27
6SG7	44	39	78	49	39
6SH7GT	40	32	80	40	38
6SJ7GT	44	37	83V	79	69
6SK7GT/G	49	39	84/6Z4	49	39
6SL7GT	49	47	85	49	45
6SN7GT	49	47	99V	35	25
6SQ7GT/G	44	37	99X	35	25
6SD7	49	39	117Z6GT/G	89	76
6U6	49	39	182B	99	89
6U7G	35	25	1231	39	29
6V5G	59	49	1644	29	19

## COMPARE OUR PRICES!

Minimum Order \$1.00

WHEN ORDERING — Send 25% deposit for all C.O.D. Shipments. Include sufficient postage—EXCESS WILL BE REFUNDED. Orders without postage will be shipped express collect. All prices F.O.B. New York City.

# SENCO RADIO INC.

71 West Broadway, New York 7, New York  
 Telephone — Beekman 3-6498

For the Sharpest, Clearest Pictures

# INSTALL A WORKSHOP RECEIVING SYSTEM

In many locations, the ordinary television antenna does not provide enough "signal strength" for even the finest receivers. Workshop custom-designed Receiving Systems, because of their "high gain," will bring you pictures with brilliant clarity -- even at places far beyond the normal range.

Here's what users say! --

—"My WORKSHOP 6-element high-gain antenna brings in Chicago stations 225 miles away." -- New York City

—"Ghosts and noise have completely disappeared since I installed your Television Receiving System." -- New York City

—"The tough winter brought down a lot of antennas in my neighborhood, but my rugged Workshop antenna stood up beautifully." -- White Plains

—"I get wonderful reception on baseball games 125 miles from Cleveland with your antenna system."

Many new television stations will come on the air soon. Play safe with a Workshop Receiving System -- it is designed to take care of them.

Write for Free Television Catalog

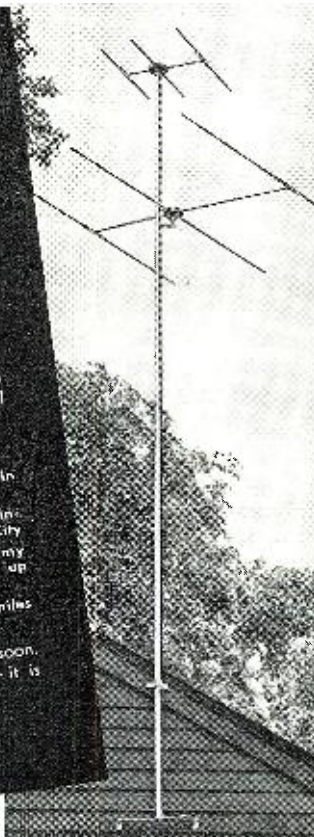

**THE WORKSHOP ASSOCIATES, INCORPORATED**  
62 Needham Street, Newton Highlands 61, Mass.

## ALMO PRESENTS THE JERROLD TV BOOSTER

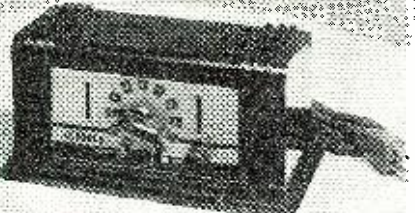

This new Jerrold Booster has a minimum of 30 Db gain across the entire 6 megacycle bandwidth of each TV channel. Channel selector switch tunes easily to selected station. Vernier control matches impedance of any TV antenna.

- Fringe area reception is greatly improved, and all interference from FM, short wave, amateur and other broadcast is greatly reduced or eliminated completely.
- In city areas the Jerrold Booster may be used with any indoor antenna, or just a wire tucked under the rug or behind the receiver.

Your order will be shipped the same day as received. Send check, money order, or C.O.D.

**List \$34.50 Dealer Net \$20.70**

10% CASH WITH ORDERS



**Covers the Globe**

PHONE Lombard 3-9225

509 Arch Street, Phila. 6, Pa.

## RADIO TUBES

For immediate shipment  
R.M.A. Guaranteed  
Individually Sealed Cartons

GT Types		Miniature Types	
6K6GT	.40	1S5	.50
6K5GT	.46	1T4	.55
6V6GT	.46	1R5	.55
6SA7GT	.46	3S4	.55
6SJ7GT	.46	6BA6	.50
6SK7GT	.46	6BE6	.50
6SQ7GT	.46	6AT6	.42
6X5GT	.40	12BA6	.50
12SA7GT	.46	12BE6	.50
12SQ7GT	.46	12AT6	.42
12SK7GT	.46	35W4	.42
12SJ7GT	.46	50B5	.55
35L6GT	.40		
35Z5GT	.32		
50L6GT	.46		

25% DEPOSIT REQUIRED ON C.O.D.—2% C.O.D.  
10% DISCOUNT ON LOTS OF 50 OR MORE.

**RAVAC ELECTRONICS CORP.**  
432 Fourth Avenue  
New York 16, N. Y.

Justice Hugo L. Black, FCC Chairman Wayne Coy, FCC Commissioners George E. Sterling and Rosel H. Hyde, and Justice Harry W. Edgerton of the U. S. Court of Appeals.

Praising Mr. Durr's accomplishments at the commission, Mr. Coy said: "Today the name of Clifford J. Durr stands high on the roll of those who have contributed to American broadcasting in the public interest. He has always had before him the vision of broadcasting as a palladium of the peoples' liberties."

**EVERYONE WAS SHOCKED** to hear of the sudden death of Harry Diamond, chief of the Electronics Division of the National Bureau of Standards. One of the inventors of the radio proximity fuze, Mr. Diamond was widely honored for his outstanding work. He had received the 1940 Award for Engineering Achievement of the Washington Academy of Sciences; the Naval Ordnance Development Award for Exceptional Service, 1945; and the War Department Certificate for Outstanding Service in 1945.

Commenting on Mr. Diamond, Dr. E. U. Condon, director of the Bureau said: "He was an unusually gifted, capable and conscientious scientist and administrator. His creative work included basic research that led to the development of the instrument landing system for aircraft, the development of the radiosonde and the development of automatic weather stations . . . His career was a distinguished one, and one devoted to the interests of his country; as a scientist and a man, he was a great public servant."

. . . . . L.W.

### Communications Receiver

(Continued from page 52)

ohms to 297,000 ohms will cause the frequency to change approximately 3 kc. This type of b.f.o. frequency vernier has its good points. A small variable condenser shunting the b.f.o. tuned circuit will accomplish the same results, but unless shielded, will spray r.f. This r.f. voltage is in the order of several volts, and the sensitivity of the r.f. channel is in the order of a few microvolts. Stray r.f. from the b.f.o. can exceed the incoming signal several hundred times.

With the present design it is necessary to couple the b.f.o. to the second detector of the narrow and sharp channel to obtain a beat note which indicates the leakage is quite low. The b.f.o. does not operate on the wide-band channel.

The b.f.o. frequency control is smooth and operates like an audio oscillator when the receiver is tuned to a steady carrier.

The "R" meter circuit is the conventional screen bridge type, utilizing the screen voltage variation due to different levels of a.v.c. action with approximately 5 db. per "R" sensitivity.

**BC-375  
MOPA  
TRANSMITTER**

**A really  
fine buy!**

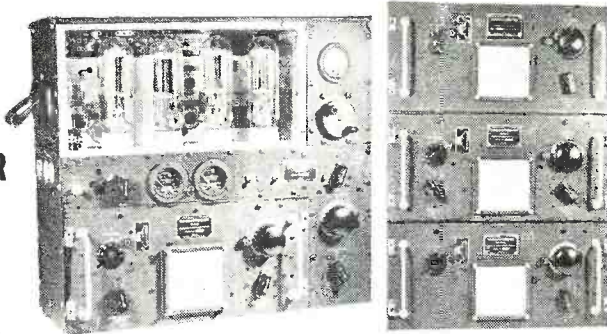

The most famous of all surplus transmitters. Was used by the Army bombers and ground stations during the War. Frequency range is covered by means of plug-in tuning units as shown below. Each tuning unit has its own oscillator and power amplifier coils and condensers, and antenna tuning circuits all designed to operate at top efficiency within its particular frequency range. Transmitter and accessories are finished in black crackle, and the milliammeter, voltmeter, and RF ammeter are mounted on the front panel. **FREQUENCY RANGE:** 200-500 Kc. and 1500-12,500 Kc. (Will operate on 10 and 20 meter band with slight modification.) **OSCILLATOR:** self-excited, thermo-compensated, and hand calibrated. **POWER AMPLIFIER:** neutralized class "C" stage, using 211 tube, and equipped with antenna coupling circuit which matches practically any length antenna. **MODULATOR:** Class "B"—uses two 211 tubes. **POWER SUPPLY:** Dynamotor which furnishes 1000 V. at 350 Ma. Conversion instructions and diagram for 110 V. AC furnished upon request for \$1.00. **PRICES:** As follows:—

Transmitters only.....	<b>\$12.50</b>
Tuning units TU-5B, TU-6B, TU-7B, TU-8B, TU-9B, TU-10B, TU-26B, choice.....	<b>\$2.50</b>
Dynamotor PE-73C.....	<b>\$3.95</b>
Antenna tuning unit (BC-306A).....	<b>\$4.95</b>

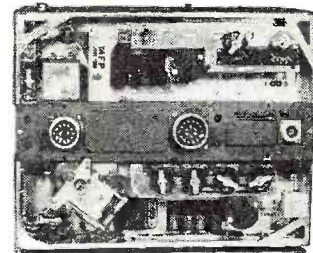

**SCR-522 100-156 Mc.  
RECEIVER AND TRANSMITTER**

One of the most interesting and useful pieces of surplus equipment. Designed for plane and ground station use, this unit offers remote control of any four pre-selected crystal controlled frequencies in the spectrum of 100-156 Mc. This spectrum covers fac-simile, air navigation aids, airport control, railroad, police, urban telephone, as well as the amateur band 144-148 Mc. October Radio News gives details for converting the SCR-522 receiver section, BC-624.

Transmitter section, BC-625, is voice amplitude modulated and has an output of 8-9 watts. Tubes used and included: 2—832, 3—12A6, 1—6G6, 2—6SJ7, 1—12J5GT, 3—12SG7, 1—12C8, 1—9002, 3—9003, 1—12AH7GT. Used with tubes, dynamotor and remote control. Price..... **\$29.75**

**24V—L-3  
50 AMP  
LEECE NEVILLE  
AIRCRAFT**

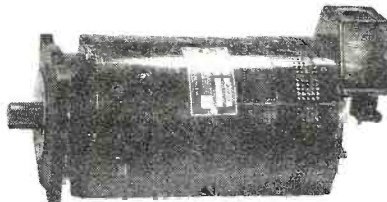

**GENERATOR FOR HEAVY DUTY WORK**

24 V L-3—50 Amp—Leece Neville aircraft generator for heavy duty work. Can be used on automobile, etc., for that 24V rig. Weight 24 lbs.—5" diameter—11" long—(3/4" diameter; 1" length shaft) Brand new..... **\$17.50**

**NAVY ARB  
RECEIVER**

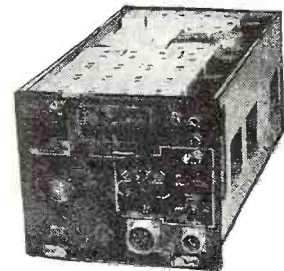

195 Kc. thru 9 Mc. Includes broadcast band. Can be converted easily to a good ham receiver. 28 V. DC input. Covers 4 bands. This is a deluxe type super-het receiver. Note: The frequency coverage includes the standard broadcast band. Has 4-gang tuning condenser; can be converted to 110 V. AC receiver. Complete with tubes: 12SF7, 12SA7, 3—12SF7 and 12A6. Dial is built on front of chassis. Electric driven or manual band change switch. Weight 28 lbs. Size 6" x 7" x 15". Complete with tubes and dynamotor..... **\$19.95**

**MAGNESYN INDICATOR (remote) COMPASS**

Selsyn type meters, 12-25 V. AC, 60 cycle, or DC. For use on beam antennas, in same method as Selsyn Indicators type 1-81 and 1-82..... **\$1.60** each

**BUSS FUSES—CARTRIDGE TYPE** packed ten to a box.

6 amp. 250 V. non-renewable.....	<b>\$.40</b>
3 amp. 250 V. non-renewable.....	<b>.40</b>
6 amp. 250 V. renewable.....	<b>.75</b>
3AG 10 amp. Glass fuses .02.....	<b>1.35</b> per hundred

**CONDENSER-AEROVOX**

.25 mfd. 20,000 DC working volts. Size 4" x 8" x 16" overall height. Weight 28 lbs. Price..... **\$4.50**

**COMMAND SET COMPONENTS**

Receivers: BC-454 3-6 mc.....	<b>\$5.75</b>
Transmitters: BC-457 4-5.3 mc.....	<b>5.75</b>
BC-458 5.3-7 mc.....	<b>5.75</b>
BC-456-E MODULATOR w/DYNAMOTOR 28 V. DC.....	<b>2.95</b>
ANTENNA RELAY RE-2/ARC-5.....	<b>1.95</b>
CONTROL HEADS C-26/ARC-5.....	<b>1.95</b>
TRANSMITTER RACKS (double rack).....	<b>1.00</b>
RECEIVER RACKS (triple rack).....	<b>1.50</b>
RECEIVER RACK (single rack).....	<b>.75</b>



**Radio Co**  
130 W. New York St.  
Indianapolis 4, Ind.

Unless Otherwise Stated, All of This Equipment Is Sold As Used **CASH REQUIRED WITH ALL ORDERS** Orders Shipped F.O.B. Collect

## for your BEAM!

- \* Runs on 24 to 33 volts AC or DC (4 amp. transformer will do)
- \* Reversible — only three wires required.
- \* 7000 to 1 Gear Reduction stops free swing.
- \* Approx. 3/4 RPM.
- \* Powerful 1/4 H.P. motor, rugged precision gear train, and sturdy thrust bearing — will support and turn even a heavy dual beam.

Used on aircraft to control pitch of propeller blades, these dependable power units are excellent beam rotators (see pages 22, 23, 29, Nov. QST. Used, but in perfect tested working conditions, with instruction sheet ..... **\$8.95**

Your Net Converted **\$10.95**  
(Mail orders add \$1.25 for packing)



## Look at these EXCLUSIVE War Surplus BUYS!

**DC POWER SUPPLY**  
Price Only (HRU)

**\$69.50**

24-28 V at 70 Amp. 2000 watts gasoline engine generator with electric starter. Power supply which can be used to operate 24-28 V. equipment, start airplane engines, charge batteries.

Shpg. Wgt. 115 lbs.

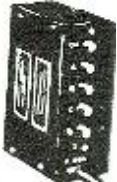
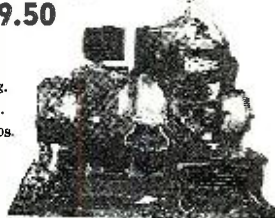

### ATTENTION!!!

All SCR-522 Owners Remote Control Boxes for SCR 522's. Brand New in Original Packing; consists of 5 push button switches, 5 Western Electric Pilot Assemblies, with Pilot Bulbs and Dimmer, and Lever Switch all finished in Black Crackle. Order yours Today.

Your Cost, **79c EA**

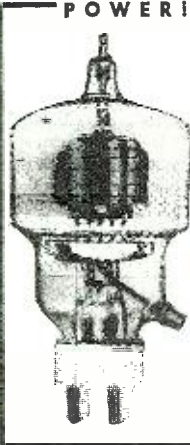

**POWER!! POWER!!**

**EIMAC 304TH**

BRAND NEW JAN. INSPECTED

**SUPER VALUE**

BETTER ORDER 4 OR MORE TODAY

**90c EA**

WHILE THEY LAST—ANY QUANTITY

**Super Special EIMAC 304TH Brand New ea \$3.95 JAN. INSPECTED**

**Sound Powered Phones & Chest Set with Mike \$4.95**

**Vertical Antenna MAST KITS**

Fully Adj.

5 to 35 Feet

Easy to Set-up

FOR FM, TELEVISION AND ROTARY BEAM COMPLETE

**\$9.95**

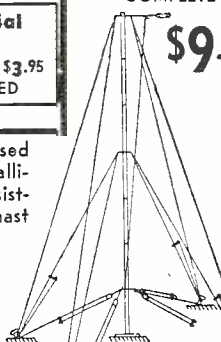

### SCOOP!

**110 M.C. REC. BARGAIN**

BC-733 Localizer Receiver

Freq. 108-110 Mc; Tube complement: 10 tubes - 1-12SQ7, 2-12SR7, 1-12A6, 1-12AH7, 2-12SG7, 3-717A. NEAR NEW CONDITION.

Companion to the glide path receiver.



Also contains 90 and 150 cycle band-pass filters. Has the best AVC system yet developed; can use parts or use as a model for construction. 10 tubes, crystals, relays, etc. Schematic included. Don't pass this up! With Dynamotor. At only ..... \$3.95 2 for \$7.50

**DOW RADIO**  
LA RY16683—SY31196

BE SURE TO ASK FOR OUR BIG SPECIAL BULLETIN

**1759 EAST COLORADO BLVD. PASADENA 4, CALIFORNIA**

Doublet Antenna Kit, used with the famous Hallcrafters BC-610, consisting of 7 steel-alloy mast sections in a handy canvas bag. Each section is 5'6" long, 1 1/2" OD with the last 6" rolled to a smaller OD to telescope into the end of the preceding section. No taper. Assemble into mast up to 35' high or shorter by any multiple of 5'. Finished in weatherproof olive drab. Ideal for erection of FM and Television Beams! Drop your coaxial cable right through the center! Brand new, export packed.

TERMS: F.O.B. Pasadena unless postpaid. No C.O.D.'s under \$2.00. 25% deposit on ALL orders. All C.O.D.'s shipped by Rail Express. Save freight and C.O.D. fees by sending full price with order and we will ship by fast truck, transportation collect. Minimum order \$2.00. Californians include 2 1/2% sales tax.

The a.v.c. bus is common to both i.f. channels. The wide-band i.f. tube operates the "R" meter regardless of which i.f. channel is in operation.

The noise limiter uses a 6H6 tube in series with the audio output of the second detector. The noise limiter operates only when the narrow and sharp i.f. channel is used.

There are two power sockets, P<sub>1</sub>, P<sub>2</sub>, and one audio terminal board, P<sub>3</sub>, located on the rear of the chassis. One socket connects by means of a cable to the power supply and audio chassis. The other socket connects the cable to the tuner chassis. The audio terminal board is connected by means of a shielded lead to the audio input jack on the audio chassis.

The chassis layout can be established by checking the circuit diagram with the top chassis view. Main components are shown on both the photograph and circuit diagram.

To simplify construction the circuit diagram has been blocked off into four sections. Construction sequence should start with Section One. When this section is completely wired and tested, start Section Two. Repeat the same procedure for Sections Three and Four. Following this procedure will reduce the possibility of error. If trouble does develop, it will be easy to isolate and correct.

First, mount all sockets, both tube and power. A solder lug should be mounted under each tube mounting nut. Next, mount all i.f. transformers, switches, and controls. Wire only Section One.

Section One consists of the following; wide-band i.f. stage and its second detector, "R" meter, power sockets, audio output terminals, and connections to selectivity switch, S<sub>1</sub>.

Two small holes are located underneath each i.f. transformer. Use one hole for primary leads (red and blue) and the other for secondary leads (green and black). The second lead hole will be located near the appropriate tube socket grid prong.

First, wire power sockets P<sub>1</sub> and P<sub>2</sub> on rear flange of chassis. Several leads interconnect between these sockets. Next, wire all tube filaments in parallel and connect filament wires to power socket pins numbers 2 and 7. The filament contacts on all tube sockets are numbers 2 and 7. These leads need not be twisted but should be dressed flat on the chassis.

The location of ground points in i.f. and r.f. amplifiers is almost as important as making correct wiring connections. Poorly located ground connections cause regeneration and in some cases oscillation.

Number one pin connection is the shield on all tubes used in the i.f. channel. Solder the number one pin to the nearest solder lug. All screen, plate filter, and cathode bypass condensers associated with a particular tube should ground to this same point as indicated in the circuit diagram. The a.v.c. bypass condensers do not go to ground; instead they connect to the

## FOR BEST FM PERFORMANCE TROUGH-LINE FRONT END Tuned RF Amp.—Mixer—Oscillator

- High Gain
- Image Rejection 100 to 1
- Low Noise Factor
- A Quality Product
- 75 to 120 MC or 140 to 150 MC



Complete building instructions for IF amplifier \$3.00  
Wired and Tested ..... **\$18.95**  
IF Amp. 10.7 MC ..... **\$50.00**

**WARDELL SMITH**

65 Glenwood Rd. Upper Montclair, N. J.

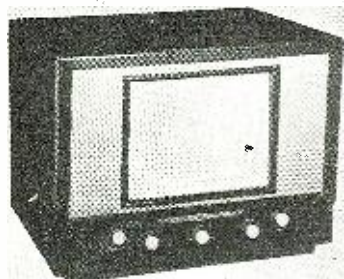

### MASTERPIECES IN CABINETRY

Television cabinets specially engineered for 12" and 15" Standard and De Luxe "Transvision" models. Also available for 12" and 15" Standard and Champion "Television Assembly" models. Exclusively designed tables to match. Various finishes. Write for particulars.

**TEL-CRAFT COMPANY**

108 Havemeyer St. Brooklyn 11, N. Y.

cathode of the tube. To the man with little radio experience, this will present no problem. Men with considerable radio experience may have to almost force themselves to wire according to this instruction. The reason for this statement is as follows.

Experience teaches that a bypass condenser grounded to the chassis in a majority of cases will operate satisfactorily. It has become common practice to pay little attention or no attention to the proper location of bypass grounds. Soldering to the chassis encourages this bad practice.

The use of an aluminum chassis eliminates the possibility of soldering to the chassis. An easy way of obtaining grounds is to locate a solder lug under the tube mounting screw. In practically every case this places the ground exactly where it should be.

According to Ohm's Law, resistance must be present for a potential difference to exist due to current flow through a conductor. The d.c. resistance between two points on a chassis to another is quite low, but the a.c. impedance under certain conditions can be sufficiently high to cause regeneration when the bypass condensers which should be grounded at one point are not. Any amount of regeneration will cause the signal-to-noise ratio to decrease, and this is undesirable.

Pick one ground point for each stage and use it if at all possible. In some cases this will be difficult, and the use of another ground point then becomes necessary.

The i.f. transformer mounting screws make convenient locations for tie points, since they are invariably located near the associated tube socket. Mount appropriate multiple tie points near the tube socket for a.v.c.,

Fig. 6. Selectivity curve of i.f. system. Curves were obtained by changing signal generator frequency and increasing input signal to maintain a 50 mw. output.

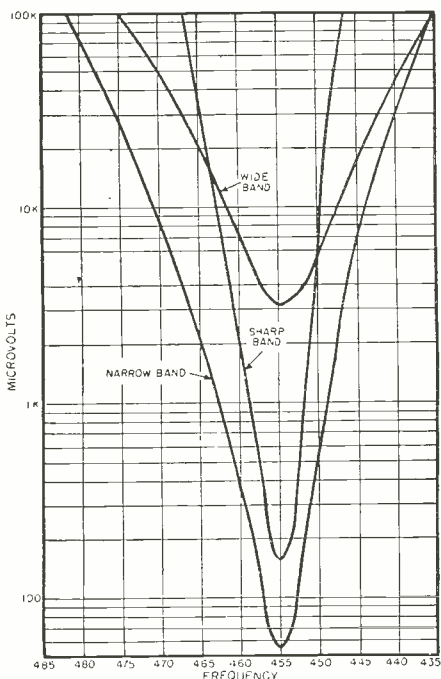

## THE NEW MODEL 247

# TUBE TESTER



Checks octals, loctals, bantam jr. peanuts, television miniatures, magic eye, hearing aids, thyratrons, the new type H.F. miniatures, etc.

### Features:

- ★ A newly designed element selector switch reduces the possibility of obsolescence to an absolute minimum.
- ★ When checking Diode, Triode and Pentode sections of multi-purpose tubes, sections can be tested individually. A special isolating circuit allows each section to be tested as if it were in a separate envelope.
- ★ The Model 247 provides a super sensitive method of checking for shorts and leakages up to 5 Megohms between any and all of the terminals.
- ★ One of the most important improvements, we believe, is the fact that the 4 position fast-action snap switches are all numbered in exact accordance with the standard R. M. A. numbering system. Thus, if the element terminating in pin No. 7 of a tube is under test, button No. 7 is used for that test.

Model 247 comes complete with a new speed-read chart. Comes housed in handsome, hand-rubbed oak cabinet sloped for bench use. A slip-on portable hinged cover is indicated for outside use. Size: 10 3/4" x 8 3/4" x 5 3/4". ONLY.....

**\$29.90** NET

## THE NEW MODEL 257

# ELECTRONIC ANALYZER

THE MOST COMPLETE MULTI-RANGE, MULTI-SERVICE UNIT EVER DESIGNED!!

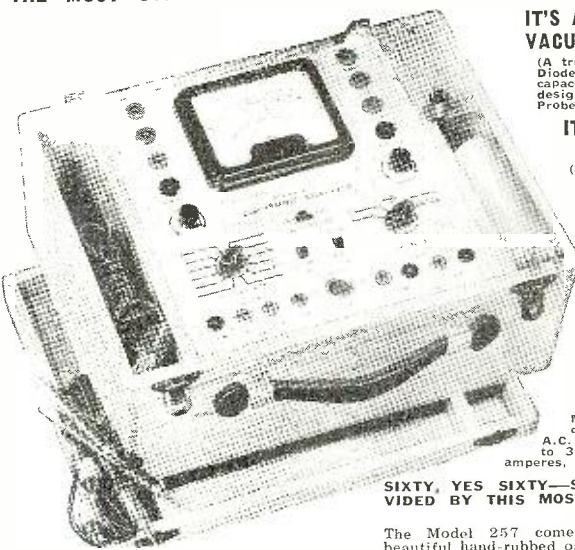

IT'S A HIGH FREQUENCY A.C. VACUUM TUBE VOLTMETER

(A true A.C.-V.T.V.M. employing a 1-A3 Diode which together with a resistance-capacity network is built into a specially designed Polystyrene High Frequency Probe.)

IT'S A D.C. VACUUM TUBE VOLTMETER

(At 11 megohms input resistance.)

IT'S A CAPACITY METER

IT'S A REACTANCE METER

IT'S AN INDUCTANCE METER

IT'S A DECIBEL METER

IT'S A 1000 OHMS PER VOLT V.O.M.

Measures D.C. Voltages (at 1,000 ohms per volt) up to 3,000 volts. A.C. Voltages (at 1000 ohms per volt) up to 3,000 Volts. D.C. current up to 15 amperes. Resistance up to 1000 megohms.

SIXTY, YES SIXTY—SEPARATE RANGES ARE PROVIDED BY THIS MOST VERSATILE UNIT EVER DESIGNED

The Model 257 comes housed in a beautiful hand-rubbed oak cabinet complete with test leads, V.T.V.M. probes and instructions. Size: 6 1/2" x 10 3/4" x 14"

**\$57.50** NET

### Specifications

**A.C. V.T.V.M. VOLTS:** (Input resistance—10 megohms shunted by 8 microfarads. Freq. Range—50 cycles to 500 Megacycles)  
0 to 3/15/30/75/150/300 Volts.

**D.C. V.T.V.M. VOLTS:** (At 11 Megohms Input Resistance)  
0 to 3/15/30/75/150/300/750/1500/3000 Volts.

**D.C. VOLTS:** (At 1,000 Ohms Per Volt)  
0 to 3/15/30/75/150/300/750/1500/3000 Volts.

**A.C. VOLTS:** (At 1,000 Ohms Per Volt)  
0 to 3/15/30/75/150/300/750/1500/3000 Volts.

**D.C. CURRENT:**  
0 to 3/15/30/75/150/300/750 Ma.  
0 to 3/15 Amperes.

**RESISTANCE:**  
0 to 1,000/10,000/100,000 Ohms.  
0 to 1/10/1,000 Megohms.

**CAPACITY:** (In MFD)  
.0005—2.05—20 .5—200.

**REACTANCE:**  
10 to 5M (Ohms) 100—50M (Ohms).  
.01—5 (Megohms).

**INDUCTANCE:** (In Henries)  
.035—14 .35—140 35—14,000.

**DECIBELS:**  
—10 to +18 +10 to +38 +30 to +58.

20% DEPOSIT REQUIRED ON ALL C.O.D. ORDERS

**MOSS ELECTRONIC DISTRIBUTING CO.**

DEPT. RN-9, 229 FULTON ST.

NEW YORK 7, N. Y.

**PREMAX**

**NEW**  
**For TV**

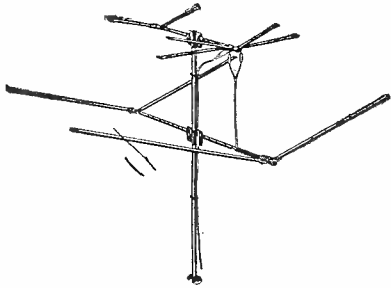

**LO-HI 3-DIMENSION  
ANTENNA Gets All 12**

- SIMPLE
- EASY TO ERECT
- RUGGED CONSTRUCTION
- COVERS ALL CHANNELS

Premax Lo-Hi Television Antenna is radically new and severely simplified in design for quick, easy assembly and erection and for rugged strength and service.

Two completely separate arrays, each consisting of dipole antenna and reflector, provide maximum signal pickup for all 12 channels, in both low and high frequency bands. Both are mounted on the same mast but thru a simple device each is adjustable in BOTH horizontal and vertical planes, entirely independent of each other. Spacing between arrays may be varied at will. They are interconnected into a single electrical system by a new circuit licensed under the A.A.&K. patents.

Get complete details on this revolutionary, low-cost, all-channel Antenna.

**ASK YOUR JOBBER**



**4813 Highland  
NIAGARA FALLS, N. Y.**

screen, plate filter, diode filter, and load resistors.

When Section One is complete, connect the intermediate amplifier chassis to the power supply and audio chassis and test. (For testing procedure refer to "Testing Procedure.")

After Section One has been tested and is working satisfactorily, start on Section Two.

Section Two consists of the narrow and sharp-band channel. The main component parts are  $T_1$ ,  $T_2$ ,  $T_3$ ,  $V_1$ ,  $T_4$ ,  $V_2$ ,  $T_5$ ,  $V_3$ . Wire this section, keeping in mind the wiring suggestions offered in the discussion covering Section One. Audio coupling condenser  $C_{33}$  should connect directly to selectivity switch  $S_1$  instead of the plates of  $V_5$ , the a.n.l. tube. This will allow Section Two to be tested without wiring Section Three. When Section Two is completely wired, connect and test.

The wiring of Section Three is simple and should take less than an hour. Note that condensers  $C_{11}$  and  $C_{31}$  bypass the same lead. Condenser  $C_{11}$  is located near  $V_3$ , and  $C_{31}$  is located near  $V_5$ . This lead is high impedance and long. Bypassing on both ends reduces the possibility of regeneration or hum pick-up.

The coupling between the b.f.o.  $V_5$  and  $V_3$  consists of a piece of hookup wire with one turn wound around the diode lead of  $V_3$ .

When this Section is completely wired the same test procedure should be followed as for Sections One and Two.

Section Four is the narrow-band FM section. It consists of  $V_4$ ,  $T_6$ , and  $V_5$ .

Discriminator transformer  $T_6$  was made by modifying a Miller 912C4 i.f. transformer. This transformer lends itself to modification since it is slug tuned. Transformers tuned by variable condensers present a more difficult problem. The minimum capacity of the variable condenser tuning the secondary may be too high with

the addition of condensers  $C_{16}$  and  $C_{17}$ . These two condensers establish the center point for condenser  $C_{15}$ . Resistors  $R_{16}$  and  $R_{17}$  complete the d.c. path for the two diodes.

The primary winding is shunted by resistor  $R_{14}$ . The purpose of this resistor is to lower the "Q" of the discriminator transformer.

**Construction Notes**

The "R" meter  $M_1$  has a 200 micro-amp movement. The use of a meter with a different current rating will require a change of resistor values.  $R_{27}$  is the zero adjustment resistor. If zero is not obtained by the adjustment of  $R_{27}$ , change the value of  $R_{26}$ . The correct value of resistance will have to be determined by experimentation.

Resistor  $R_{28}$  determines the sensitivity of the "R" meter. Decreasing the value of  $R_{28}$  will cause the "R" meter sensitivity to increase.

The low impedance lead wire used to connect  $T_1$ ,  $T_1$ , and  $T_3$  is Amphenol microphone cable. The wire is constructed like regular transmission cable using the same type insulation but with the over-all diameter considerably reduced. One ground point is established near selector switch  $S_1$ , and all three transformer leads ground at this point only.

This same type shielded wire is used to connect the audio switch deck of  $S_1$  to the audio output terminals.

The third switch deck on  $S_1$  is used to change the cathode resistor value of  $V_1$ . There is a change of gain when the sharp section, consisting of i.f. transformers  $T_1$  and  $T_2$ , is switched into the circuit. By switching cathode resistor  $R_{21}$  in and out of the circuit, the over-all gain of the i.f. channel remains comparatively the same for narrow- and sharp-band operation.

There are three blank switch sections on selectivity switch  $S_1$ . These sections are available for future needs.

Resistors  $R_{31}$ ,  $R_{35}$ , and condenser  $C_{26}$

Fig. 7. Details of the modified i.f. transformers used at  $T_1$ ,  $T_3$ , and  $T_1$ .

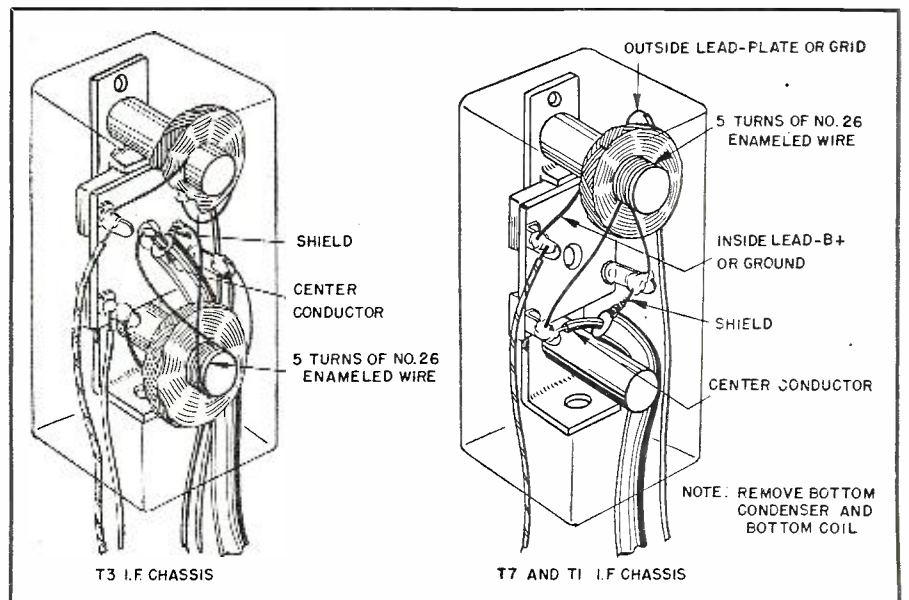



# INDUSTRIALS! EXPERIMENTERS! Look at these EXCLUSIVE "G&G" BUYS!

JUST ARRIVED!

## TUBES

thousands of them!

Famous Makes • Boxed and Bulk • Rock-Bottom Prices

SPECIAL! SPERTI R-F Vacuum Switch

Famed Collins Xmtr Antenna Switch. 9200 peak volts. 8 amperes. BRAND NEW!

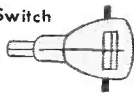

Only.....\$1.69

12SH7	\$.40	6J5/GT	\$.40	1486	\$.52
6AK5	\$.50	5T4	\$.72	786	\$.55
35L6	\$.45	6W7/G	\$.75	6H6/GT	\$.40
12SK7	\$.45	25Z6/G	\$.45	2X2, 879	\$.50
12SJ7	\$.50	2051	\$.45	65C7	\$.65
6C4	\$.40	VR-150	\$.65	7F7	\$.65
1LA6	\$.70	6AL5	\$.66	6S7J	\$.55
1LC6	\$.68	6A3/G	\$.83	25W4	\$.45
1LN5	\$.65	6V6/GT	\$.55	50B5	\$.59
9002	\$.45	12SA7	\$.55	8U4/G	\$.55
807	1.10	6AG5	\$.62	6H6	\$.50
RK-60	\$.60	6AC7	\$.68	1R5	\$.65
1T4	\$.60	VR-105	\$.68	6K7	\$.50
3Q5	\$.65	5V4/G	\$.72	8011	\$.65
1LH4	\$.60	1N5	\$.60	45Z5	\$.50
954	\$.45	12H6	\$.40	14J7	\$.60
955	1.10	5V4/G	\$.72	8011	\$.65
14A7	\$.50	12A6	\$.38	6L6/GA	\$.85
6SG7	\$.50	50L6	\$.55	7C5	\$.65
1LD5	\$.65	35Z5	\$.45	12K8	\$.55
16Z6	\$.45	7A7	\$.40	12K8/Y	\$.55
9008	\$.45	707	\$.48	024	\$.65
6SL7	\$.60	7Y4	\$.48	78	\$.50
6SN7	\$.60	35Y4	\$.48	77	\$.50
83V	\$.85	14Q7	\$.52	6J6	\$.60



### DC AMMETER 0-15 Amps

A terrific buy! 3 1/2" easy reading scale. 75 divisions. Black plastic case 4 1/2 x 5 1/4 x 2 1/4". Rubber covered test clip leads plus black metal carrying case with hinged cover. Brand New. Wonderful for automotive, battery charging, general test work.

Value \$25. All yours for only.....\$3.99

### McElroy Automatic KEYER

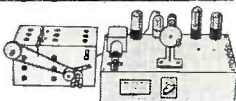

For Xmtr keying or code practice. Has photocell and sensitive relay. Variable speed motor, 110V AC or DC. Complete with 2-117Z6 and 1-117L7 tubes, your cost.....\$14.95

### CATHODE RAY TUBE BUYS!

All Brand New, in Original Cartons



5BP1	Lots of 4, each.....	\$1.79
5BP4	Lots of 4, each.....	3.95
3FP7	Lots of 4, each.....	1.49
304TL	Eimac, each.....	1.95
GE-211	Each.....	1.22
826	Each.....	.69

## Sensational Buy! Brand New COMPASS RECEIVER MN-26

3 Bands—150 Kc. to 1500 Kc.

Commercial Navigation Receiver. Remote control operation. Picks up broadcasts and shows location of any transmitting station tuned in. Includes twelve 6 volt tubes. No accessories.

Your Cost, only.....\$39.50

### U. S. Army

### Field Phone Set EE-8

Leather case, with handset, generator, ringer, etc. Requires 2 flashlight cells. Wonderful value!

Good Used ea.....\$8.50

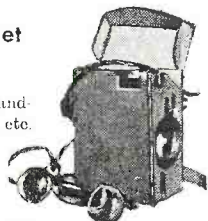

## BC-645 XMTR RECEIVER 15 Tubes 435 To 500 MC



BRAND NEW

\$975

2 FOR \$1895

supply in factory carton. Shipping weight 25 lbs.

PE-101C DYNAMOTOR for above BC-645.....\$2.95

UHF ANTENNA ASSY. for above BC-645.....\$2.45

The electronic equipment that saved many lives in the war. Set can be modified to use for 2-way communication, voice or code, on following bands: ham band 420-450 mc, citizens radio 460-470 mc, fixed and mobile 450-460 mc, television experimental 470-500 mc. 15 tubes (tubes alone worth more than sale price!): 4—7F7, 4—7H7, 2—7E6, 2—6F6, 2—955 and 1—WE316A. Now covers 400 to 490 mc. Brand new BC-645 with tubes, less power carteron. Shipping weight 25 lbs.

## BRAND NEW GE THYRATRON FG-105 MERCURY RECTIFIER Sensational Value!

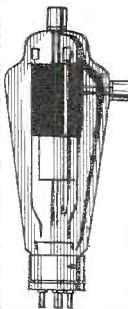

INDIVIDUALLY BOXED in factory sealed cartons. List Price \$40.00

Your Cost \$11.95 While they last

Tube of a hundred uses! One of the best ever designed for continuous service and welder control service. Selling at far below the usual price, the FG-105 has a wide variety of industrial, commercial, and domestic applications. Tetrode type, indirectly heated cathode. 10000 V peak, 10000 V peak inverse. Av. max. current: 6.4 amps on continuous service; 2.4 to 4 amps on welder control service. STOCK UP! SAVE PLENTY! ORDER NOW!

### HANDSET



Cradle-type handset with butterfly switch, unbreakable black plastic, 4-ft. 3 wire cable, BRAND NEW, individually packed, each.....\$2.75

### HANDMIKE T-17

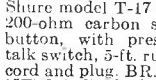

Shure model T-17 mike 200-ohm carbon single button, with press-to-talk switch, 5-ft. rubber cord and plug. BRAND NEW, individually packed, lots of 3, each.....\$1.19

HEADPHONES—All Brand New! Individually packed, complete with phone plug. HS-33 600 ohms, in lots of 3, each.....\$2.45 HS-23 2000 ohms, in lots of 3, each.....1.85 HS-30, With earplugs......99

BEDE DC METER, new, black bakelite case, 3" round 0-1000 DC Ma. Special.....\$1.95

QUANTITY PRICES—Inquiries welcomed from institutions, wholesalers, dealers, large users.... Phone, write, wire for quantity prices.

Please include 25% Deposit with order—Balance C.O.D. Minimum order \$3.00. All Shipments F.O.B. Our Warehouse N.Y.C.

G&G GENUINE MAJESTIC RADIO PARTS SERVICE 53 WESEY STREET - NEW YORK 7, N.Y.



### TERRIFIC VALUE! 24-VOLT STORAGE BATTERY, BRAND NEW! 17 AMP. HRS.

Made by Delco. 12 cells, heavy duty, very rugged. Shipped dry, uses standard sulphuric acid electrolyte.

VERY SPECIAL.....\$16.95

SPECIAL! 24 VOLT DELCO 12-CELL STORAGE BATTERY 11 ampere-hours. Only a few left at.....\$14.95

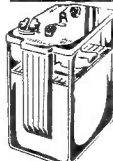

### WILLARD 2-VOLT STORAGE BATTERY 20 Ampere-Hours

Exact replacement for GE portables—brand new. Each.....\$1.95

### WILLARD 6-VOLT STORAGE BATTERY 27 Ampere-Hours

3-cell battery, transparent plastic case, very specially priced.....\$5.75

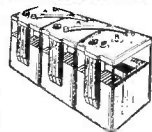

### 1-QUART BOTTLE BATTERY ELECTROLYTE

Made by Willard, for above storage batteries. 1 qt. sufficient for two 2-volt cells. Hermetically sealed. SPECIAL.....\$1.25 per qt. bottle.

7-PRONG 2-VOLT RADIO VIBRATOR for Portable and Farm Sets Replacement for GE LB 530.....\$1.65

### GOULD 6-VOLT STORAGE BATTERY

Navy Standard, Black Rubber Case. BRAND NEW. 15 Amp. Hour Rating.....\$4.95



### WILLARD 6-VOLT STORAGE BATTERY

Similar to above but in transparent plastic case. Real value at.....\$4.95

RADIO RECEIVER Brand New in Original Carton BC-454A 3.1 to 6 Mc complete with tube.....\$6.95 40-WATT VFO DRIVER BC-457A 4 to 5.3 Mc.....\$6.95 BC-458A 5.3 to 7 Mc.....6.95

## Last Minute Specials! G-E Tungar Battery Charger

BRAND NEW!

5 Amperes—Famous General Electric Tungar Charger for all automobile and radio storage batteries. Complete with 6 amp. tungar bulb and one extra spare tungar bulb.

Only \$16.50



### BIAS METER BRAND NEW!

Excellent for measuring DC voltages, bias voltages, or checking polarity of DC voltages. Designed originally for telephone and tele-type voltage measurements. With adaptor plug, schematic, metal carrying case. Batteries not needed for operation. Your cost, only.....\$5.95



### FREQUENCY METER CABINET

For BC-221 Series freq. meters. BRAND NEW! 3 compartments. Massively built 14 1/2 x 10 1/2 x 10". Value \$20.00. Complete with canvas cover for both ends. Yours for only.....\$3.95

# STAHL'S Star Studded SPECIALS

## METERS

4 1/4" Round Westinghouse 0-150V DC; panel mounting. Type DX. **\$4.95**

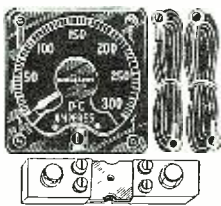

4 1/4" Square Westinghouse 0-300 amp. DC, flush; complete with shunt and leads. Type KX-24.

**\$7.95**

2" Round Westinghouse Bakelite Case 0-30 Milliamps D.C. **\$2.25**

3" Round Western Electric 0-1000 Mill D.C. Bakelite Case **\$2.25**

3" Round Beede 0-1000 Mill D.C. Bakelite Case **\$1.95**

3" Round Westinghouse 0-15 Mill D.C. Bakelite Case **\$3.45**

4 1/2" Weston Panel Board flush metal case 0-5 amp. A.C. with a 0-200 amp. scale. **\$3.95**

## RADIO COMPASS SELSYN INDICATOR

1-81-A-Radio Compass; works on 16 to 25 Volt AC has three inch -0-360° dial. **\$2.45**

2 for **\$4.45**

## Voltage Regulator

G. E. 110 to 220V AC, 400 cycle, single phase-15 amp. -20 W; 0-7.2 ohms/2.75 amp; black wrinkle finish metal case



**\$4.95**

## Transtat Voltage



Regulator Type RH 115V AC, 400 cycle 7.2KVA-output 75 to 120V @ 6 amp. black wrinkle finish metal case. Weight 11 lbs. **\$2.45**

Western Electric Crystals 1N23. .35c each; 3 for **\$1.00**

11power quartz crystal units, type CP5, 5000 KC. complete with holder. **\$1.95**

Standard rack cabinets heavy gauge steel, gray crackle finish; panel opening 19" wide, 27" high. **\$12.95**

Parallel No. 18 Zip wire; 10 feet lengths, with lugs on each end. Each. **10c**

Hammarlund variable APC210 micro microtarad. **50c**

Sola step down-or up transformer, 200 V. center tapped to 110V; 60 cycle; cap. V.A. 50; **\$3.95**

Jefferson step down (or up) power circuit transformer double wound 230V input 50-60 cycle, to 115V output, 250KVA. Weight 17 lbs. **\$7.95**

Metal case, black wrinkle finish.

## Control—G.E.

28V DC-95 amp. load; can be used to control motors, radio transmitters, receivers, etc. Complete with ten 12V relays. **\$4.95**



RCA-CRV-51019 Hand Sets self contained battery operated. Uses 4 pen light batteries excellent for Television Antenna installation. Sold in pairs only. **Pair \$15.00**

TS-10P Sound power handsets in original export packing. **Each \$15.00 2 for \$27.95**

## CS Differential

Dual coil with armature pivoted between coils. All contacts normally open. Operates 220-250 Volts, 8000 Ohms each coil, contacts S.P.D.T. Controls rated 2 amps. at 110 VAC. Ideally suited for balanced or bridge type circuits where limited current or power is available. Will withstand 12 G. Vibration up to 60 cycles at 35,000 feet altitude. Special low price. **89c**



## ANTENNA TUNER

BC-306-A Section, high voltage, heavy duty 5 position RF switch. 2 Standoff insulators with spring type binding posts. National Velvet Vernier 100-0 scale dial. Low frequency variocoupler. **\$1.95**

## RADIO ANTENNA

9 sliding sections—open 7 ft.—closed 1 ft. attached to mounting bracket. Ideal for Home, Auto or Boat. Very Practical for Video, F.M. or transmitting; while they last. Special. **\$1.95**

## 1/6 HP Motor

Split phase, 110V AC, 60 cycle-1 phase, 725 RPM—Resilient mounted, 1/2" shaft. Brand new, in original cartons. **\$12.95**



## Oscilloscope

3"—14991B—can be rack mounted; operates on 6VDC or 110VAC. Complete with 2-6116; 4-6SF5; 1-6S17GT; 1-6S17GT; 2-5Y3GTG; 1-3P1; in original export packed cases. **\$49.50**



Brand New. Complete set of spare tubes same as above plus 1 extra 3P1 in export packed case. **\$12.50**

## BLANK CALIBRATION BOOKS

For BC 221-Frequency from 125KC to 20000 KC printed in .10 divisions—68 pages, aluminum cover, spiral bound. **\$1.50**

Prompt Delivery—25% deposit required on C.O.D. order. Shipped F.O.B. New York—Write Dept. RN9.

**MICHAEL STAHL, INC.**  
**39 VESEY ST.**

New York 7, N. Y., WO 4-2882

## ALL-WAVE RADIO KIT



A two tube plus rectifier receiver kit. Operates on 110 volts A.C. or D.C. using three type 76 tubes. Plug-in coil for broadcast band included with kit. This set is capable of real long-distance reception. Supplied with complete and easy to read instructions and diagrams, less tubes and headphones.

Two tube (plus rectifier) receiver kit. **6.32**

Three type 76 tubes. **2.45**

70-200 meter plug-in coil. **.51**

35-70 meter plug-in coil. **.51**

17-35 meter plug-in coil. **.51**

545-1500 meter plug-in coil. **1.25**

Send for bulletin No. 295 on other kits

**FOTO-RADIO CO., INC.**

257 Huntington Ave., Boston 15, Mass.

## SELSYN MOTOR VALUE

115 Volts 60 Cycles

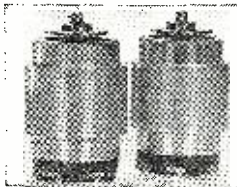

**\$7.25 Per Pair**

From NEW gun directional control units. Excellent for rotary beam directional control and indication. Operate in pairs as transmitter and receiver. Diameter 3/4", length 4 1/2". Designed to connect direct to your 115 volt, 60 cycle, A.C. line.

Pair (2 units), with diagram. **\$7.25**

Quantity Discount available

**WEBER ELECTRIC**

150 Maple Ave. Dept. 4, Hershey, Penna.

form the high frequency correction network for the wide-band channel.  $R_{34}$  and  $R_{35}$  form an audio voltage divider. Condenser  $C_{26}$  shunts  $R_{34}$ .

As the audio frequency increases, the reactance of  $C_{26}$  decreases. This changes the ratio of the audio voltage divider, increasing the high frequency range. At high audio frequencies (5000 cycles) there is attenuation due to the selectivity of the i.f. channel. The frequency correction network operates in direct opposition, resulting in practically flat audio response out to 5000 cycles.

Resistor  $R_{22}$  is the manual i.f. gain control. Switch  $S_2$  is the a.v.c. switch. This switch simply grounds out the a.v.c. bus.

## Coil Modification Data

The i.f. transformers,  $T_7$  and  $T_1$  are modified as follows. The Miller 912C1 i.f. transformer consists of two identical windings, one coil located above the other. Remove the bottom coil but do not disturb the coil form or iron core. Remove the coil shunting condenser from the terminal board. This leaves two blank tie points on the terminal board.

Wind five turns of Number 26 enameled wire around the coil form of the upper winding and secure the coil leads to the two blank tie points on the terminal board. Secure the winding to the coil form with wax or insulating cement.

Connect a piece of Amphenol shielded mike cable to the two tie points. The center conductor connects to one tie point and the shield to the other. Make this lead eight inches in length.

The i.f. transformer  $T_3$  is a Miller 912C2 with the low impedance coil added. Drill two small holes in the terminal board and use these holes to secure the low impedance coil leads to the Amphenol mike cable. The winding in this case is five turns of Number 26 wire wound around the coil form of the lower winding.

The discriminator coil  $T_6$  is a Miller 912C4 with the following modification. Remove the 100  $\mu$ fd. condenser which shunts the secondary winding. Replace this capacity with two 200  $\mu$ fd. condensers in series. Condenser  $C_{15}$ , a 50  $\mu$ fd. unit connects between the plate coil tie point and the centertap of the two 200  $\mu$ fd. condensers. Resistor  $R_{11}$ , 20,000 ohms, shunts the primary winding.

## Cable Construction

The cabling consists of two octal plugs and a length of shielded six-wire cable. The shield connects to the number 1 pin in either plug. The six wires connect to pin numbers 2, 3, 4, 5, 6, 7. Make sure the wires connect to the corresponding pins in each plug.

The cable used to connect the i.f. chassis to the tuner chassis is constructed in the same manner with the addition of another shielded lead. The center conductor connects to the number 8 pin in either plug. The shield connects to the number 1 pin. It is

necessary to cut or drill an additional hole in the metal plug caps to clear the additional shielded lead. *Amphenol* mike cable is used for this lead.

**Test Procedure**

The use of a signal generator is required. Connect the i.f. chassis to the power supply and audio chassis by means of the cable and shielded audio lead. Ground the number 5 power socket connection.

Rotate the selectivity switch, *S*<sub>1</sub>, to the wide-band position. Turn on the power supply and allow the unit to warm up for approximately one minute.

Connect the signal generator to the number 8 pin and ground of socket *P*<sub>1</sub> on the i.f. chassis. Set the signal generator to 455 kc.

Before applying a signal to the wide-band channel, adjust the "R" meter zero with resistor *R*<sub>27</sub>. If the "R" meter will not adjust to zero, change the value of *R*<sub>27</sub> until it does. Plate voltage variation may require this change.

Apply a 455 kc. signal increasing the input level until the "R" meter starts to indicate. Adjust i.f. transformers *T*<sub>1</sub> and *T*<sub>2</sub> for maximum "R" meter indication, decreasing the signal input so the meter reads on scale.

If the signal generator is calibrated in microvolts, a sensitivity measurement can be made. A signal input of 200 microvolts should produce an a.v.c. voltage of approximately 1 volt.

When the signal generator is modulated 30% at 400 cycles, an input of 65 microvolts should produce approximately 50 milliwatts output with the audio volume control wide open.

The test procedure for the Second Section (narrow- and sharp-band channel) is approximately the same. Place the selectivity switch in the narrow-band position. Increase the signal generator input until the "R" meter indicates. Adjust i.f. transformers *T*<sub>3</sub>, *T*<sub>4</sub>, and *T*<sub>5</sub> for maximum meter indication reducing the input so the meter reads on scale at all time.

Next rotate the selectivity switch to the sharp-band position. Tune i.f. transformers *T*<sub>1</sub>, *T*<sub>2</sub>, and *T*<sub>3</sub> for maximum meter deflection, reducing the signal generator input to maintain a center scale reading on the meter at all times.

With narrow-band operation an input of 20 microvolts should produce an a.v.c. level of approximately 1 volt. The sharp-band sensitivity will be approximately 25 microvolts for the same a.v.c. level.

When the signal generator is modulated 30% with 400 cycles, an input of approximately 10 microvolts should produce an audio output of 50 milliwatts with the gain wide open.

During these tests the i.f. gain control *R*<sub>22</sub> should be rotated so the arm of the pot is positioned at ground potential.

Section Three test procedure is as follows. Place the selectivity switch in narrow- or sharp-band position.

# TRANSVISION

## BIGGEST VALUES in TELEVISION!

**Large-Image, Direct-View TV Kits at Low Cost!**  
**Kits Engineered for EASE of ASSEMBLY and Top Performance.**  
**Cabinets designed and built for Beauty, Utility, Durability.**  
**NO TECHNICAL KNOWLEDGE REQUIRED FOR ASSEMBLY**

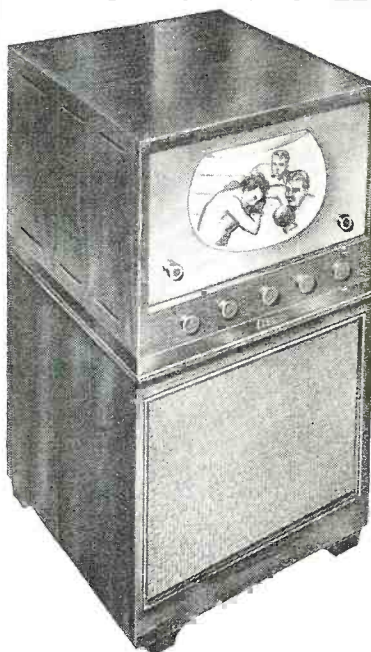

**Console Model 7CL**

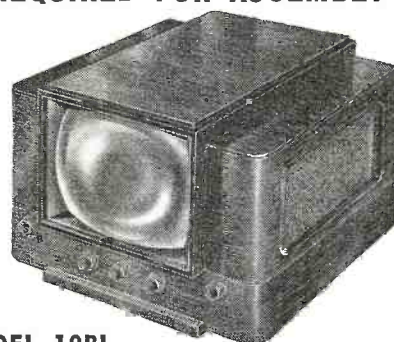

**MODEL 10BL**

**Gives 115 Sq. In. Picture**

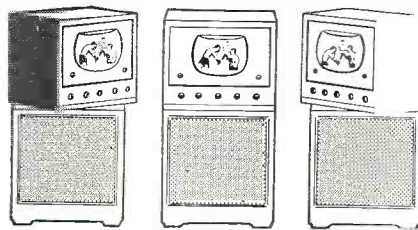

**Roto-Table for Full 180° Visibility**

TRANSVISION manufactures the most extensive line of high quality Television Kits, Cabinets, and Components. Models illustrated and listed here are only representative of Transvision's leading values. See your distributor.



**MODEL 10BL**, TV/FM Kit, gives 115 sq. in. picture; complete FM Radio; receives all channels; streamlined cabinet... **NET \$299.00**  
**Roto-Table** for Model 10BL, gives full 180° visibility... **NET \$ 24.95**  
**MODEL 7CL**, TV Kit, gives 60 sq. in. picture; console cabinet with Roto-Table; streamlined design... **NET \$199.00**  
**MODEL 7BL**, same as 7CL except that it is a table model... **NET \$189.00**  
 All prices include cabinets, tubes, antenna, and 60 ft. of lead-in wire. (Models 7CL and 7BL can be supplied with complete FM Radio for small additional cost.)

**—FREE—**  
**Fascinating**  
**BOOKLET**  
**On Television**

Illustrated 20-page 2-color booklet gives you excellent basic information on television. Call at your distributor's for a **FREE COPY**; or write to us for names of distributors.

**"SERVICE NOTES"**  
**BY**  
**TRANSVISION**

the Key to Successful Television Servicing... Confidential Television Notes and Information, product of experience with over 20,000 television sets. Complete with photos, diagrams. Worth a small fortune. Cost is only **\$1.95 NET**



All prices 5% higher west of Mississippi; all prices fair traded. For further information see your distributor, or write to:

**TRANSVISION, INC. Dept. R.N. NEW ROCHELLE, N. Y.**

**In Calif.:** Transvision of California, 8572 Santa Monica Blvd., Hollywood 46

**For TELEVISION, It's TRANSVISION — the complete line of High Quality Kits, Cabinets, Antennas, Lenses, Filters, Boosters, Components — Ask your distributor!**

## PEAK SURPLUS BARGAINS



### 50 MICROAMP METER

This is the exact 20,000 ohm per volt meter utilized in the General Electric Model YMW-1A Lab-Type Unimeter.

- 0-50 Microamp Movement  $\pm$  2%.
- 2500 Ohms Resistance  $\pm$  2%.
- Knife Edge Pointer.
- 4 x 4 1/2 Inch Black Bakelite Case.
- Well Spread Multi-range Scale.
- Brand New, Individually Checked.

**TERRIFIC VALUE—ONLY \$9.75 EA.**



### A BRUTE

A hefty filter choke with an honest-to-godness rating of 6 henry at 550 m. i. l. s. We emphasize "at." 28 ohms DC resistance. Built to Signal Corps specs. and beautifully cased as illustrated. Size 5 x 4 1/2 x 5 1/2. Net weight 14 lbs.

**ONLY \$4.95 EA.  
2 FOR \$8.90**

### FOR FILAMENTS

Conservatively rated, this transformer delivers 5 volts at 15 amps running "ice cold." Has two separate 115 volt primaries 25 to 60 cycles. 110 or 220 volt input. Ideal for tubes such as 35T, HK254, 100TH, 250TH, HK257, etc. Cased as illustrated above. Size 5 x 4 1/2 x 5 1/2. Weight 10 lbs.

**\$3.75 EA.—2 FOR \$6.80**

### A HUSKY BABY

This rugged plate transformer was designed for good regulation. It has two separate 115 volt, 25 to 60 cycle primary windings. (115 or 230 volt input.) Output 820 volts center tapped at 775 m. i. l. s. Excellent regulation even under 600 milli load. Makes a wonderful plate supply for running lots of equipment simultaneously. Built to rigid government specs. Size 6 1/2 x 6 1/2 x 7—4 mounting holes on top and bottom. Fully shielded as illustrated above. Net weight—36 lbs.

**ONLY \$7.95 EA.—2 FOR \$14.50**

### SCOPE TRANSFORMER

Hermetically sealed 1800 volts, 4 ma., 6.3 volts, 9 amp. 2 1/2 volts, 2.5 amps. 110 V. 60 cy Primary. 5 x 3 1/4 x 3 3/4. \$5.95

### STEPDOWN TRANSFORMER

220 to 110 volts. 50 to 60 cycle. 100 watts. \$2.49 ea.

### CLOSEOUT BARGAINS

Vibroplex's	.....	\$ 6.95
2-11 mmf Butterfly with ball bearings	.....	.59
G.E. SPD Relay 10,000 ohm coil	.....	.59
Heineman Circuit Breaker, 110 V. AC 5 amp	.....	.89
G.E. Solenoid with microswitch	.....	.69
Ohmite 25 ohm 25 W. rheostat	.....	.39
Microswitch (interlock) 10 amps	.....	.59
W.E. Choke 4.3 by 620 ma 42 ohms	.....	4.95
Triumph Commercial Phones	.....	4.50
Veeder Root Counter	.....	.95
Choke 8 by 160 ma 140 ohms	.....	1.39
TPDT Antenna Relay—110 V. AC Isolantite	.....	1.95
C-H Switch DPST 1/2 H.P. Bat handle	.....	.95
CD.002 Mica 7500 Volts test	.....	.69
CD 16 mfd 450 V Can with leads	.....	.69
100 Ohms 50 Watt Rheostat	.....	.69
200 Ohms Dual 50 Watt Rhea.	.....	.85
10 Henry 350 Mill Choke	.....	3.75
1.5 Henry 250 MA. Choke	.....	.79
4 Hy. 900 Mill. 28 Ohms. 5KV	.....	19.50
.0001, 5000 WV Mica	.....	.69
CH DPST, 40 Amp Toggle	.....	.95
Hammarlund HFBD 200C Variable	.....	1.95
15 Meg. 1% Precision Resistor	.....	.39
6AK5 Boxed	.....	.59

### Standard "METERS" Brand New

1 1/2" 0-1 ma Basic	.....	\$3.95	3" 0-75 amp AC	.....	\$3.95
2" 0-5 ma Basic	.....	1.95	3" 0-2 ma DC	.....	3.95
2" 0-1.2 ma	.....	2.49	3" 200-0-200 V.	.....	
2" 150-0-150	.....		DC	.....	2.95
Microamp	.....	3.49	3" 0-1 ma DC	.....	3.95
2" 0-30 amp DC	.....	3.49	3" 0-20 ma DC	.....	3.95
2" 0-1 ma Basic	.....	2.95	3" 0-15 ma DC	.....	3.95
3" 0-50 amp AC	.....	4.95	3" 0-150 V. AC	.....	3.95
3" -10 to +4	.....		3" 0-50 Microamp	.....	9.95
DB	.....	5.95	3" Running Time	.....	
3" 0-80 ma	.....	2.95	110 V. 60 cycle	.....	7.95
3" 500-0-500	.....				
Microamp	.....	4.50			

### OIL CONDENSERS

11 mfd 250 vac.	.....	\$0.85	.1 mfd 7500 vdc.	.....	1.95
5 mfd 150 vac.	.....	.49	.15/.15 mfd 8 kv	.....	2.75
1 mfd 600 vdc.	.....	.29	dc	.....	2.75
2 mfd 600 vdc.	.....	.39	4 mfd 8 kv dc	.....	19.95
4 mfd 600 vdc.	.....	.59	.01/.01 mfd 12 kv	.....	5.75
3,3 mfd 600 vdc.	.....	.79	dc	.....	5.75
10 mfd 600 vdc.	.....	.95	.005/.01 mfd 12 kv	.....	5.50
14 mfd 600 vdc.	.....	1.35	dc	.....	5.50
2 mfd 1000 vdc.	.....	.79	.03 mfd 16 kv dc	.....	5.75
4 mfd 1000 vdc.	.....	.95	.65 mfd 12500	.....	12.95
15 mfd 1000 vdc.	.....	2.95	vdc	.....	12.95
2 mfd 1500 vdc.	.....	1.25	.75/.35 8/16 kv	.....	12.95
1 mfd 2000 vdc.	.....	1.45	dc	.....	7.95
3 mfd 3000 vdc.	.....	3.95	.02 mfd 20 kv	.....	17.50
1 mfd 5000 vdc.	.....	4.50	.1 mfd 25 kv dc	.....	17.50
.15/.15 mfd 6000	.....				

If not rated, 25% with order, balance C.O.D.—Minimum order \$3.00.

### PEAK ELECTRONICS CO.

188 WASHINGTON STREET, DEPT. MR  
NEW YORK 7, N. Y.

Rotate the b.f.o. frequency control  $R_{20}$  to approximately center rotation. Adjust the signal generator input for a "R" meter reading of half scale. Next adjust the slugs on transformer  $T_6$  so an audible beat note is produced. Both tuned circuits of  $T_6$  should be tuned to approximately the same frequency. This can be determined by noting the length of each adjustment screw.

Rotation of the b.f.o. frequency control will cause the beat note frequency to change.

The a.n.l. stage  $V_6$  is tested later in conjunction with the tuner.

Section Four is tested in the following manner. Rotate the selectivity switch to the narrow-band FM position. Modulate the signal generator with 400 cycles. Adjust the signal input for approximately half scale "R" meter reading. Connect a loudspeaker to the output of the amplifier. Connect a voltmeter to the hot side of condenser  $C_{20}$  and ground. The maximum voltage at this point will be approximately one volt.

Adjust the primary tuning of  $T_6$  for maximum audio output. Adjust the secondary tuning so the voltmeter reads zero. The polarity of voltage will change if the secondary circuit is detuned to either side of resonance. The polarity will also change if the frequency of the signal generator is increased or decreased slightly from 455 kc.

Another indication of proper alignment is the AM rejection. When both the primary and secondary windings of  $T_6$  are correctly aligned, maximum AM rejection will result. The 400 cycle modulation will completely disappear if the alignment is correct. Final adjustment of the primary circuit should be made in favor of AM rejection.

Limiting action will take place with a signal input of approximately 5 microvolts. With the added gain of the tuner, the limiting action will start with less than 1 microvolt input.

The flat portion of the discriminator curve shown in Fig. 4 is approximately 16 kc. wide.

The following regeneration test should be made with each i.f. channel.

Adjust the signal generator input so the "R" meter reads "R9". Very slowly increase the frequency of the signal generator and observe the action of the "R" meter. Next decrease the frequency of the signal generator and observe the action of the "R" meter.

If there is no regeneration present the "R" meter reading will decrease smoothly on both sides of resonance. The presence of regeneration will cause the "R" meter to indicate another peak at some frequency other than 455 kc. If such a peak does appear in one of the i.f. channels, it will normally be accompanied by a "frying" noise in the audio output.

Connect a two foot length of Amphenol mike cable to the low impedance input circuit of the i.f. channel. Strip 1/2 inch of the shield from the free end of the cable, exposing 1/2 inch of the center conductor. Hold the exposed end of the cable near the grid and plate leads of each amplifier tube.

When the cable is held near the stage which is causing the regeneration the "frying" noise will increase sharply. This test will isolate the regeneration to a particular stage.

Regeneration is normally caused by defective bypass condensers, capacity between component parts or wires, or incorrect ground points. Some mechanical layouts arc such that complete elimination of regeneration is impossible.

The i.f. channel described will produce no "frying" noise with the volume control wide open. This means that an input signal will not be obstructed by noise created in the i.f. amplifier.

If the i.f. transformers are stagger-tuned a second peak may appear. Repeat the tuning procedure several times to make sure all transformers are tuned to exactly the same frequency (455 kc.).

The amount of i.f. gain attenuation offered by  $R_{21}$  is governed by the value of  $R_{22}$ . Reducing the value of  $R_{22}$  will increase the attenuation of the i.f. gain control.

The value of resistor  $R_{21}$  is adjusted

Fig. 8. Underchassis view of the i.f. section. Note the careful placement of parts.

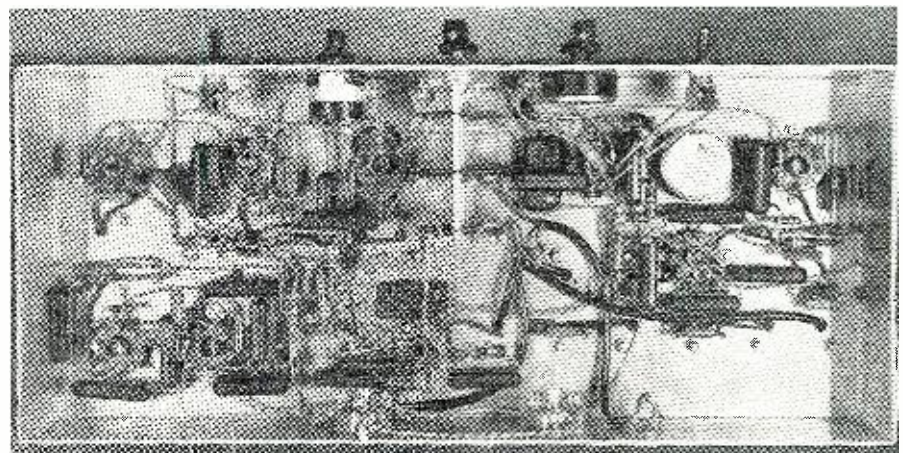

Our 26th Year

**A LEEDS LEADER**

- 50 microamp Movement ± 2%
- 2500 ohms DC Resistance ± 2%
- Knife Edge Pointer
- 4x1 1/2" Black Bakelite Case
- Easily Read Multitester Scale



This is the exact meter utilized in the G.E. YMW-1A Lab Type Unimeter. A Great Special. Each **\$9.75**

**SELSYN MOTORS**



115 Volt AC 60 cycles. Transmitters only. Can be used to turn small beam antenna or as indicators only. 3 1/2" Diameter x 5 1/2" High. Shipping weight 10 lbs. Special Per Pair—

**\$5.95**



**RELAYS—CS DIFFERENTIAL**

Dual coil with armature pivoted between coils. All contacts normally open. Operates 220-250 Volts. 8000 Ohms each coil, contacts S.P.D.T. Controls rated 2 amps. at 110 V.A.C. Ideally suited for balanced or bridge type circuits where limited current or power is available. Will withstand 12 G Vibration up to 60 cycles at 35,000 feet altitude. Special low price **88c**



**MULTIPLE CONTACT**

Telephone Type #882—2 windings. Each 125 ohms. #881—Single winding. 12500 ohms.

**49c**



Quality-Price-Dependability

**TUBES**

- 3C24 Triode 100 Watts output: 6.3 Volts 3 amp. Filaments 2000 Volts plate @ 75ma. Each 39c....10 for **\$3.50**
- 805 Triode 370 Watts output: 10 Volts 3.25 amp. Filaments 1500 Volts plate @ 210ma. ....Each **3.00**
- 2x2/879 Rectifier 2.5 Volts 1.5 amp ..... **.49**

**CHOKES**

SMOOTHING		SWINGING		BOTH	
Type	Hy	Type	Hy	MA	Price
C-80	10	C-87	4-16	150	<b>\$2.70</b>
C-81	10	C-88	4-16	200	<b>3.45</b>
C-82	10	C-89	4-16	250	<b>5.35</b>
C-83	8	C-90	3-14	300	<b>5.85</b>

All Above 3000 Volts Insulation

**PLATE TRANSFORMERS**

For Small Transmitters. DC Voltage Ratings are Approx. Values Obtained at Output of a 2 Section Choke Input Filter. Using Mercury Vapor Rectifier Tubes. Pri. is for 115 V. 60 cy.

Type No.	Sec. Rms. Volts	Sec. DC Volts	DC Sec. MA.	Dimensions			Price Each
				H.	W.	D.	
<b>P 57</b>	660-660†	500	250	4%	3 1/8"	4 3/8"	<b>\$5.55</b>
	550-550	400					
<b>P 58</b>	1080-1080	1000*	125	4%	3 1/8"	5"	<b>7.20</b>
	500-500	400	150				
<b>P 59</b>	900-900	750	225	4%	3 1/8"	5 1/8"	<b>6.00</b>
	800-800	600					
<b>P 67</b>	1450-1450	1200	300	5%	6 1/8"	4"	<b>17.85</b>
	1175-1175	1000					

\* For dual operation with simultaneous use of both sec. ratings. † Has 40-volt bias tap.

**FILAMENT TRANSFORMERS**

- 2 1/2 Volts C.T. @ 10 Amps. 7500 Volt RMS Type **\$2.40**
- 40
- 6.3 Volts C.T. @ 3 Amps. 2500 Volt RMS Type **1.65**
- 46

**POTENTIOMETER WIRE WOUND**

100,000 ohm, precision made G.H. type. 25 watt. 6" diameter. Brand New. **\$1.95**



**METERS**

- 0-100 ma 2" Round McIntock **\$1.95**
- 0-1 amp RF 2" Round G.E. **2.45**
- 5-0-5 amp DC Charge and Discharge 2" Round **.69**
- 100 amp-6 volt DC 4 1/2" square scale complete with 100 amp shunt **2.95**



**WIRE**

- No. 10 Copper Enamel, 100 Ft. Lengths. Each **\$1.75**
- No. 12 Copper Enamel, 100 Ft. Lengths. Each **1.25**
- No. 14 Copper Enamel, 100 Ft. Lengths. Each **.83**
- 300 Ohm, Twin Lead Plastic covered, per 100 Ft. **1.95**
- RG-59U 72 Ohm Coaxial Cable, 7c per Ft., per 100 Ft. **6.75**

**H&H Wire Wound Rheostat**

150 watts, 5.0 Ohms @ 5.48 amps, in approximately 67 steps. Resistance Wire wound toroidally around refractory core and embedded in vitreous enamel 4" diameter. Depth behind panel 1 1/4". Makes excellent control for Toy Trains. A Buy at **\$1.95**



**NATIONAL COMPANY DIALS**

Direct Calibration Dials—5:1 Drive Ratio

- ACN—7/4" W. x 5" H. **\$3.30**
- ICN—7/4" W. x 5" H. with illuminated scale. **\$6**



NPWO—Gear Drive 20:1 Ratio. Shaft perpendicular to panel with Micrometer Dial. ....\$9.00  
PWO—Gear Drive 20:1 Ratio. Shaft parallel to panel with Micrometer Dial .....\$9.90

We Carry a Complete Line of National Parts and Receivers

**DM—43A DYNAMOTOR**

Manufactured by G.E. New. Input 24 V. @ 23 amps. 7500 RPM; output 515/1030/2/8 V. **\$2.95**  
@ 215/260 milliamps; filtered. Special

**OIL-FILLED CONDENSERS**

- 7.5 Mfd. 330 V.A.C. Nationally known... **98c**
- 10 Mfd. 600 V.D.C. .... **98c**
- 2 Mfd. 1000 V.D.C. Nationally known.... **69c**

If not rated 25% with order, balance C.O.D. All prices F.O.B. our warehouse New York. No order under \$2.00. We ship to any part of the globe.

**LEEDS RADIO CO.**

Dept. RN9  
75 VESEY STREET  
CORtlandt 7-2612, New York City 7

**FILAMENT TRANSFORMER**

Primary 115/230 volt 60 cycle. Secondary 5 volts at 15 Amps. 5000 volt insulation. Swell for 35T, 75T, 100TH, 250TH, HK-54, etc. Completely shielded dimensions 4 1/4 x 5 x 5/8. Net Weight 10 lbs. **\$3.95**  
Special.

**PLATE TRANSFORMER**

Primary 115/230 Volt, 25-60 cycle. Secondary 820 Volts Center Tapped at 775 Ma. Hardly and voltage drop at 950 Ma. Completely shielded. Dimensions 6 1/2 x 6 1/2 x 7 1/2. Net Weight 36 lbs. **\$7.95**  
Special.



**HEAVY DUTY CHOKES**

6 Henries at 550 Ma. 28 Ohms. DC Resistance. High voltage insulation. Completely shielded. Dimensions 5 1/2 x 4 1/2 x 5 1/2. Net Weight 15 lbs. **\$4.95**  
Special.

**VARIABLE CONDENSER**

6 Gang; 1 section of .00025 Mmfd. 4 sections .000035 Mmfd. 1 section of .00005 Mmfd. with 5 air trimmers of 15 to 25 Mmfd capacity. This condenser is all silver plated. Each only **95c**

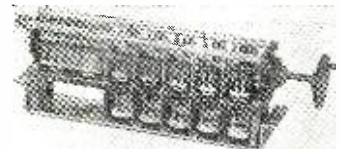

**INSULATOR**

Porcelain Beehive type stand off insulator. Type 4451-J, stands 4 1/2" high, with 2 1/4" square metal base for mounting, with jumbo banana jack in top.

Each 24c; 10 for **\$2.00**



# Chicago

## INSTRUMENTS

### Quality at Low Cost!



For years, Chicago Instruments have given radio men accurate, dependable service. And because of simplicity of design and freedom from "gadgets" we have been able to hold down prices to a fraction of what you would normally pay for instruments of similar quality.

Chicago Instruments are available in a variety of ranges and sensitivities. You may see them at your Suppliers or get the complete details by writing for Bulletin No. 10.

#### POCKET VOLT-OHM-MILLIAMMETERS FOR ONLY \$5.25

Anyone can now own a good volt-ohm-milliammeter. There is a Chicago V.O.M.A. priced at only \$5.25. Chicago "Featherweights" that slip easily into the pocket are the original miniature radio test instruments. They are popular throughout the world.

CHICAGO INDUSTRIAL INSTRUMENT CO., 536 W. ELM ST., CHICAGO 10, ILL.

## TALLEN SPECIALS WORTH READING

### AT LAST

The R5/ARN-7 Aircraft Receiver is Converted to 110V AC, 60 cycles. Get yourself a real 4 Band Radio Set. One Switch will get you any of the following 4 Bands you choose:

100-200 KC      410- 850 KC  
200-410 KC      850-1750 KC



And the Worm Gear Tuning Control is used for fine tuning. Just plug it in and get real reception. Included with set you get a 12 inch Jensen or Taybearn Speaker. High Fidelity Volume Control Pad for voice Coil Silencing, 600 ohm Input, Encased in Metal Housing.

**\$59<sup>50</sup>**



### SPECIAL:

Radio Compass Receiver R5A-ARN7; CAA Approved. **\$250**  
Originally cost \$2,500. Our price, a Bargain at .....

#### PRIVATE TELEPHONE

Your own private phone, no fuss or bother. Can be used for long distance. Consists of 2 French type handsets, as shown. 100 ft. of



double connecting wire, everything set, all ready to work. Construction sheet enclosed. Complete price **\$12<sup>95</sup>** only.



#### POWER UNIT ASSEMBLY

Complete power plant S.O.S. emergency transmitter. Includes Gear Case and Gear Train with socket 1 3/4" dia. 1 1/2" sq. cut hole for hand crank, governor for gear train assembly which operates generator. Dimensions 5 1/8" long x 5 1/2" wide x 6" deep. Unit consists of Gear Train, 2 28 V Bulbs, 28 V Relay and 8 Mfd condenser. This unit can be used as a portable power unit for receiver and transmitter etc.

Voltage supply 28 V DC @ .75 Amp  
300 V DC @ .040 Amp

Motor 5000 RPM. Also has keyer for automatic transmission of S.O.S. Price **\$575**

#### S.O.S. DISTRESS SIGNALING EQUIPMENT

Transmitter BC 778 which automatically emits SOS signal which can be heard 500 miles. Complete with tubes.

300 Ft. reel copper wire Generator-Hand driven Lights Handles, Wraps, etc. Price... **\$9.95**  
2 Balloons Rubber, Heavy, inflates to 4 ft. dia. .... Each **\$1.95** **3.90**  
2 Hydrogen generators.....Each **\$ .95** **1.90**  
2 Inflating Tubes.....Each **\$ .25** **.50**  
Knapsack 3 Cu. Ft. water & moisture repellent felt lining..... **.95**  
Box Kite collapsible 17" SQ x 34" High..... **1.49**  
Reel of braided antenna copper wire 300 Ft. **1.49**

SAVE **\$3.23** Total **\$20.18**  
Take Everything for **\$16.95**

Write for Quantity Discounts  
Prompt Delivery—Write Dept. RN )  
25% Deposit Required on C.O.D. Orders  
Shipped F.O.B. Minimum Order \$2.00

### TALLEN CO., INC.

564 Atlantic Avenue  
Brooklyn 17, New York  
Tel. TRIangle 5-3241

to maintain approximately the same gain for narrow- and sharp-band operation.

The gain of the wide-band channel is considerably less than the gain of the narrow and sharp channel. The use of the wide-band channel is primarily for high fidelity broadcast reception. The gain of this channel is more than adequate for this type of reception.

The selectivity curve in Fig. 6 indicates the selectivity of the i.f. channel only. The actual selectivity of the complete receiver is increased due to the added selectivity of the tuned circuits in the r.f. tuner.

(To be continued)

#### Efficient Servicing

(Continued from page 45)

publicity you can have. Even if an adjustment is made and the set repaired again free of charge, the customer will lose faith in your ability and will talk about you while you are doing the gratis job.

To eliminate kick-backs, the set should be tested thoroughly while it is on the bench. Don't replace one component that has failed and call the job finished. Test each stage. Measure the voltages. If the voltages are more than 20% off there is usually something wrong, even though the set sounds O.K. Low plate voltage on the plate of an i.f. tube could mean that the primary winding of the i.f. transformer is corroded and about to open up. Should the "B" voltage be considerably lower than normal, it would indicate that the rectifier tube should be replaced, or the electrolytics are low in capacity.

Bias voltages, also, should be carefully checked. If the bias on an audio tube is even one volt less than it should be, it will seriously limit the amount of signal that can be handled without distortion. The grid bias of the output tube will also indicate the presence of leakage in the coupling condenser. If there is one megohm of resistance in the grid circuit, only one microampere of leakage through the coupling condenser will change the bias one volt. One tenth of this amount is all the leakage that should be tolerated.

The effectiveness of bypass condensers can be checked by measuring the signal voltage across them with a v.t.v.m. or signal tracer. Only too often does a bypass condenser decide to open up and the set break into oscillation right after it is given back to the customer.

All tubes should be tested. Tube testing was abandoned by many servicemen during the war, but very often it will save a lot of future trouble. Even if you don't have the replacement for a weak tube, mention it to the customer and he will not feel badly about it if the tube fails. In fact, he will think more of you for it.

RADIO & TELEVISION NEWS

Another neglected phase of servicing is alignment. Every set should be properly aligned after it has been repaired. Not just the broadcast band; if there are short-wave bands, line them up. The customer will quickly recognize you as one who knows his business.

Finally when repairs have been completed, the set carefully aligned and the cabinet made as presentable as possible, give it a good working test. Let it play for a few hours. You don't have to watch it every minute, but you can let it play and listen to it now and then to check on its performance.

Most radio shops are noisy places. Radios are playing, people talking and, in the summertime, electric fans are running. With all this background noise it is practically impossible to detect hum in a set. Yet, when the customer plays the set at night in his comparatively quiet home, the hum will show up and sometimes be unbearable.

Not every serviceman has the money or space to build a soundproof room in which to test for hum, but it is possible to locate it in at least two other ways. The simplest method is to turn the volume down and feel the speaker cone with your fingers. There shouldn't be any vibration at all. With a little practice you can learn to detect even small levels of objectionable hum in this way.

A more elaborate method is to measure the a.c. across the voice coil of the speaker with an ordinary low range a.c. voltmeter. This method is more accurate, but of course, a little more trouble.

A simple device that can be used to check the over-all performance of a set is a wireless record player. You can pick out one record and, after becoming familiar with the various passages in it, learn to judge the quality of the signal almost immediately. You will be surprised at how many bugs can be ironed out by this method. It provides a simple means of checking all three criteria of receiver performance; sensitivity, selectivity, and fidelity. The wireless record player can even have three tuned circuits spaced throughout the broadcast band to provide test points at different frequencies.

The last item we will consider in satisfying the customer is that old sore spot, the service bill. The customer can never seem to understand why the bill should be more than five dollars at the most.

Of course, nobody likes to spend his money for something he can't see and much less for something he knows nothing about. The wise serviceman won't take an offensive attitude when a question is raised about the bill.

The reason for most complaints is that the customer doesn't understand the reason for the amount of the bill. Of course, all the points mentioned above regarding the appearance of

September, 1948



# HAS THE VALUES!



HERE ARE A FEW TYPICAL OF WHAT IS TO BE FOUND IN THE BIG NEW B-A CATALOG #481

116 BIG PAGES PACKED WITH THE LATEST DEVELOPMENTS IN RADIO AND ELECTRONICS, Sets, Supplies and Apparatus . . . For Trade—Industry—Communications—Public Utility—Experimental and Hobby Applications.

A Bargain Section Packed With OUTSTANDING VALUES in desirable WAR Surplus and other SPECIAL VALUES.

Write For Your Copy of Catalog #481 If You Did Not Receive It.

Only \$13.88 for this Quality RECORD CHANGER



A fortunate purchase from an overstocked manufacturer enables us to offer these popular UTAH Model 650 Record Changers AT A BIG SAVING.

Features: Single post, gearless construction. Quiet and fast during change cycle. Plays 10 twelve-inch or 12 ten-inch records. Rejects any record desired. Light weight balanced tone arm with quality crystal cartridge for any standard needle.

Has heavy, die cast base plate 10 3/4" x 12 1/2". Mounting size approx. 12 1/4" x 13 3/8", extends 5 3/4" above and 2" below mounting. Operates from 110 volts, 60 cycle.

No. 40A1000 Bargain Priced, Each \$13.88

Two in Factory carton, for only \$25.00

## BIG VALUE—AC-DC Superhet

Graceful design, dependable performance anywhere. An outstanding value! Proven Superhet circuit, 5 dependable tubes (including rectifier). Full size 5" Alnico "V" PM speaker for wonderful tone. Airplane dial. Modern Plastic cabinet Ivory finish size 10 3/8" x 5 1/2" x 6 3/4".

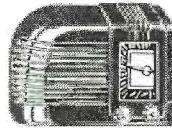

No. 31A224, SPECIAL EACH \$15.94

## 3 WAY "PERSONAL" AC.-DC. and BATTERY OPERATED PORTABLE

Superhet circuit, 4 tubes plus Selenium rectifier. 5" Alnico PM speaker. Iron core I.F. Safety switch for operation from 110 volt AC or DC electric current or from self contained batteries (1-746 "A" and 1-467 "B") available anywhere. Beautiful dual colored Polystyrene Shatter-proof molded cabinet with plastic easy grip handle. Large slide rule dial. Vernier Hi-ratio tuning. Small: only 4" wide, 8 3/8" long, 7 1/4" high. Weight only 5 1/2 lbs. with batteries. A "Money" for in the home or "on the go."



No. 36A66 Less Batteries, ONLY \$21.95

Set of batteries (1-746 and 1-467) \$2.40

## "Re-Mote" REAR SEAT

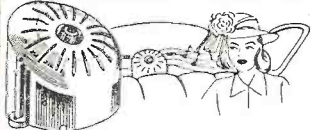

Car Radio Speaker

Easy to install in a few minutes—no cutting of holes required. Furnished complete with 17 ft. wire, fittings, resistor to match speaker to any standard Auto Radio and complete instructions. Consist of 5" quality PM speaker in beautiful marbled french gray plastic case, volume control built in.

No. 14A650 Your Cost Each \$6.37

80, 75 and 40 Meter CRYSTALS, 10 for \$3.95

In FT 243 holders, cut from highest quality quartz, accurately ground and acid etched. Frequency marked on each with in 2 KC. Sorry we must sell them in ass's. our pick of frequencies—but you can't go wrong! There are plenty of choice frequencies for 80, 75 and 40 meters or for doubling to 20 and 10 meters in each ass't. Every one guaranteed to be an active oscillator.

Stock No. 21T 3991 Assortment of TEN — ONLY \$3.95

Order direct from this ad. Our Terms: Cash With Order or C. O. D. with 20% deposit please. Radio Sets Shipped Via. Express Only.

## ALUMINUM UTILITY CASE LIGHTWEIGHT DURABLE EYE APPEALING

- IDEAL FOR
- Radio Serviceman's parts and tool kit
- Tube carrying case
- P.A. accessory case
- Camping, Fishing, Picnics, all family use

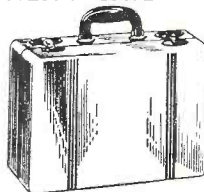

Life time aluminum case with bakelite handle, lock and key. Size 15" long 11" wide, 5" deep. Weight only 3 lbs. Shipping weight approx. 5 lbs. No. 36A75—Very Handy For Everyone, NET EACH \$3.65

## 1000 V.—200 Ma. Power Supply FILTER KIT

Consist of Two 4 mfd. 1000 volt DC oil filled condensers size 2 1/2" x 1 1/8" x 5 1/2" high overall and One Thordarson 10 Hy.-200 Ma. filter choke fully enclosed metal case size 3 3/8" sq. x 4 3/8" H.

21T3983 ONLY \$3.65

## 2 MFD. 2500 VOLT OIL FILLED CONDENSER

Well known brand. Ceramic pillar terminals, in hermetically sealed metal case, size overall 1 3/4" x 3 3/4" x 5 1/2" high. Comes with handy removable mtg. bracket and solder lug terminals.



No. 21T3990, Special, Each \$2.95

## 12 1/2 FOOT ANTENNA TELESCOPES DOWN TO 1 FOOT 4"

"Just it" for mobile equipment, portable receivers, and transmitters. Solid Brass—Ruggedly constructed—smooth telescopic action. Base is 7/8" dia. No. 38A39, Special Each \$1.95

## WEATHERPROOF WIRE at GIVE AWAY PRICES

Stranded tinned conductors (3 copper, 4 steel) flexible, yet unusually strong to stand long runs. Conductor is rubber covered with overall weather-proof saturated braid; OD 5/32".

Perfect for lead-ins, telephone, intercoms, etc. BRAND NEW in original factory wound coils.

No. 4A503, Three Conductor Per 550 Foot Coil, ONLY \$4.95

No. 4A502, As above except Single Cond. Per 900 Foot Coil, ONLY \$2.95

WRITE FOR YOUR COPY OF CATALOG No. 481 IF YOU DID NOT RECEIVE IT.



# BURSTEIN-APPLEBEE Company

1012 McGEE, KANSAS CITY 6, MO.

# LOOK at these BIG VALUES!

## 5 Watt PHONO-AMPLIFIER KIT

Build a compact 3-tube AC phono amplifier. Uses 6X5, 6V6 and 6J5. Kit includes ALL necessary parts — punched chassis, power transformer, tone and volume controls, 6-foot line cord and plug, resistors, condensers, hardware, etc.; less tubes. Easy-to-follow wiring diagram & instructions supplied. **COMPLETE**

**\$4.95**

Kit of 3 tubes for amplifier.....\$1.87  
6" Speaker with output transformer.....\$1.95



## METER SALE

### 0-1 MILLIAMETER

Basic movement for all test equipment.  $4\frac{1}{2}$ " wide... large scale, knife edge pointer. Nationally-known make. Slightly used but guaranteed electrically perfect. Order now while limited quantity lasts. A great buy!

Only \$2.75 each... \$5.00 for two

## SAVE MONEY on PARTS KITS!

- (1) 100 asstd. mica condensers; pigtail and lug types. .000005 to .01 mfd. .... **\$1.95**
- (2) 40 asstd. push-on knobs for knurled shafts. Red, green, walnut, ivory... **\$1.29**
- (3) 25 asstd. 10 and 20 watt vitreous enameled resistors. Values up to 25,000 ohms. No two alike. .... **\$1.69**
- (4) 100 asstd.  $\frac{1}{2}$ -1-2 watt carbon resistors. All RMA color-coded. Most popular values ..... **\$1.49**

ORDER BY KIT NUMBER!

## AUTO RADIO PARTS

- A 6-volt, 4-prong non-synchronous vibrators. Standard replacement for 90% of all auto radios.  $1\frac{1}{2}$ " x 3". **88¢** 12 for **\$7.50** Each
- B 5-prong synchronous vibrators for Buick sets, less buffers. **\$2.50** 5 for Popular list \$7.65. Each. .... **\$1.10**
- C 5 mfd generator condenser. Each. .... **18¢** 10 for **\$1.50**
- D SPECIAL! 66' 3-section side cowl antenna. Chrome plated, rust-resistant. Each. .... **98¢** 10 for **\$9.00**
- E Distributor suppressors— **12¢** 12 for **\$1.25** Each
- F Spark plug suppressors— **12¢** 12 for **\$1.25** Each

## SPEAKER VALUES!

- A 5" PM, heavy duty type; 1.47 oz. Alnico 5 magnet,  $\frac{3}{4}$ " voice coil. Rated 5 watts. Only **\$1.40**
- B 4" x 6" PM, Alnico 5, 1 oz. magnet. Fine replacement speaker **\$1.40**
- C PUBLIC ADDRESS SPEAKERS
- D 10" PM, 18 oz. Alnico 3 magnet. Rated 10-12 watts. .... **\$4.45**
- E 12" PM, 6.5 oz. Alnico 5 magnet. Rated 14-18 watts. .... **\$5.95**
- F 12" PM, 46 oz. Alnico 3 magnet. Rated 25 watts. **\$12.95**

## ORDER FROM THIS AD!

Select what you need from the big values listed here — and send your order now! Quantities are limited. Send 25% deposit with order. We ship C. O. D. for balance, all advertised items FOB. Chicago. GET YOUR NAME ON OUR MAILING LIST. We carry complete stock PA equipment—BOGAN, MASCO Amplifiers—Shure, Turner Mikes—University Speakers, etc. Write for complete list.

**NATION WIDE RADIO**  
(The Serviceman's Supply House)  
572 W. Randolph Street  
CHICAGO 6, ILLINOIS

the set place the customer in a better position to accept the bill, but nevertheless much adverse publicity has been given to the radio serviceman and many people take it for granted that he is a gyp.

The bill should be itemized. Under labor, usually the largest item, the various jobs performed should be itemized. If necessary, the customer should be given a non-technical explanation of the job. After all, he is paying for it and is entitled to know what he is getting, in language that he can understand.

If the job carries a guarantee, explain this to the customer. Tell him just what is covered and for how long. The time to straighten out the terms of the guarantee is when the set is delivered, not when something goes wrong and the customer thinks that he is entitled to a new set.

As a last word, remember that all customers are your bread and butter. Regardless of a man's social standing, he is the best man in the world when he comes into your place of business.

The serviceman must make a profit in order to stay in business. Before he can make a profit he must have customers. And every man that enters your door is a potential customer. Help him courteously if you can and if you can't help him, then make him glad he came in.

—30—

## SOUTHWESTERN DIVISION CONVENTION

HAMS in the Los Angeles and West Coast area are looking forward to the get-together to be held Saturday and Sunday, October 2 and 3rd in Los Angeles. Registration will open at 9 a.m. at the Alexandria Hotel, 5th and Spring Street, Los Angeles and continue all day.

Saturday's program includes an open forum, technical talks, a visit to the exhibits of the West Coast Electronic Manufacturers, YL fashion show and luncheon, code speed contest, sweepstakes mobile operation, etc. At 8 p.m. the annual dance will take place at the Alexandria Hotel. A raffle and the finale of the Royal Order of the WOOF-HONG initiation will take place in addition to a program of professional entertainment.

On Sunday, October 3rd the various groups participating in the convention will have organization breakfasts following which the committee has made arrangements for tours for interested persons. During the afternoon there will be motion pictures, demonstration of a c.w. transmitter, a hidden transmitter hunt, and finally the banquet at 6 p.m. All of the Sunday activities will take place at Farber's Parkview Manor, 2200 West 7th Street, Los Angeles.

Reservations should be made early as only 1500 can be accommodated at the banquet and with the IRE, WCEMA and ARRL conventions being held in Los Angeles the same week hotel accommodations will be at a premium. Inquiries regarding the meet should be sent to Larry Lakes, W6RMV, 3006 Wilshire Boulevard, Santa Monica, California.

—30—

## Wave Traps for TV

(Continued from page 59)

the impedance of this parallel network is low and only a small degenerative voltage appears. There is thus only a slight loss in gain.

(d) *Parallel Traps.* Parallel traps are series resonant circuits which are placed across (or in shunt with) the circuit. See Fig. 2. At the frequency for which the trap is set, it acts as a short circuit, bypassing all signals of the same frequency to ground, and preventing their further penetration into the circuit. At other frequencies the trap circuit presents a relatively high impedance, permitting these signals to proceed farther into the circuit.

The simplest type of parallel trap is illustrated in Fig. 2A. A condenser and a variable coil, in series with each other, are connected across the signal path. Any signal possessing the same frequency as the trap will "see" a virtual short circuit upon reaching this portion of the circuit. The simple condenser and coil is effective if the "Q" of this network (principally the coil) is quite high. However, when the "Q" is low, the tuning of the network is broad and more than one frequency is attenuated. A more efficient parallel trap and one which is used more extensively is shown in Fig. 2B.

At first glance, the trap network appears as a parallel resonant circuit, rather than a series resonant circuit. Let us, however, analyze its operation. The illustrative example, Fig. 2B, is taken from a DuMont television receiver. It is designed to bypass or trap the audio carrier voltage of the signal being received. In this instance the frequency is 21.9 mc.

If we consider first  $L_1$  and  $C_1$ , ignoring  $C_2$  for the moment, then we have a parallel resonant trap, tuned to 22.9 mc. The coil "Q" is 200 and a fairly large voltage is developed across the combination at this frequency. Now, it is common knowledge that for all frequencies lower than its resonant frequency, a parallel resonant circuit appears inductive. (At the resonant frequency, of course, it presents a purely resistive impedance. For frequencies above res-

Fig. 4. A Bridged-T wave trap.

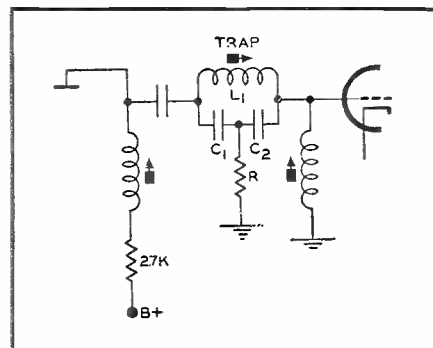



# 5130 THE NEWEST THING IN UHF. 10-350 MC. MAGNETRON IN GLASS ENVELOPE. 200 W.C.W. OUTPUT. NEW. COMPLETE WITH DATA SHEET.....\$39.50

## TUNABLE PKG'D "CW" MAGNETRONS

QR59	2675-3200 mcs	QR61	2675-3200
QR60	2800-3025 mcs	QR62	3150-3375
New \$45—each		New \$55—each	
<b>TUBE</b>	<b>FREQ. RANGE</b>	<b>Pk. PWR. OUT.</b>	<b>PRICE</b>
2431	2820-2860 mc.	265 KW.	\$15.00
2421A	2992-3019 mc.	50 KW.	\$24.00
725A	.....	.....	\$25.00
2422	3247-3333 mc.	265 KW.	\$15.00
2427	2965-2992 mc.	275 KW.	\$15.00
2432	2780-2820 mc.	285 KW.	\$15.00
2438	Pkg. 2949-3263 mc.	5 KW.	\$25.00
2439	Pkg. 3267-3333 mc.	8.7 KW.	\$25.00
2455	Pkg. 9343-9405 mc.	50 KW.	\$25.00
4431	24,000 mc.	35 KW.	\$17.50
W.E.	720Hz 2800 mc.	1000 KW.	\$25.00

**KLYSTRONS:** 723A/B—7.75, 7.07B, W/Cavity \$20, 726A,\$7.75

For 2421, 2422, 2426, 2427, 2431, 2432, and 3J31

725 A, Each.....\$8.00  
4850 Gauss, 5/8" bet. pole faces, 1 1/4" pole diam.....\$8.00  
1500 Gauss, 1 1/2" bet. pole faces, 1 3/4" pole diam.....\$8.00  
1000 Gauss, electromagnet, adjustable 23% to 3" bet. pole faces, 2 1/2" pole diam.....\$12.00

## MICRO WAVE GENERATORS

AN/APS-15A "X" Band compl RF head and modulator, incl. 725-A magnetron and magnet, two 723A/B klystrons (one sec & beam), 1B2A TR, recv-att, duplexer, HV supply, blower, pulse xmtr, Peak Pwr Out: 45 kW apx. Input: 115, 400 cy. Modulator pulse duration .5 to 2 micro-sec, apx. 13 KV Pk Pulse. Compl with all tubes incl. 715-B, 820B, 8KR 73, two 725-A. Compl pkg, new.....\$210.00

AIR-191B. Complete pkg, as above, less modulator \$150.00

"N" BAND AN/APS-2. Complete RF head and modulator, including magnetron and magnet, 417-A mixer, TR, receiver, duplexer, blower, etc. and complete pwr. With tubes ..... used, fair condition.....\$75.00

10 CM. RF Package. Consists of: 80 Xmt. receiver using 24E7 magnetron oscillator, 250 KW peak input; 707-B receiver mixer, 417-A mixer, 8KR 73, 725-A. Modulator-motor-attenuator unit for above.....\$ 75.00  
Receiver rectifier power unit for above.....\$ 25.00  
Rotating antenna with parabolic reflector for above. New.....\$75.00

RT39/A1R3-15 Transmitter-receiver. 2043 Light-house tube oscillator. 5 to 1 KW. App. 2700 Mc. operation. 30 Mc. I-F. Strip.....\$100.00

## WATER COOLED TUBES

GL 697, GL 623, GL 562, ML 100, New Guaranteed, \$75.00 ea.

## 3 CM. PLUMBING

(STD. 1" x 1/2" GUIDE UNLESS OTHERWISE SPECIFIED)

TR cavity for 724-A TR tube, transmission or absorption tubes.....\$3.50

724-A TR tube (41-TR).....\$3.50

Waveguide section, CG 251/APS-15A, 26" long choke to cover, with 180 deg. bend of 2 1/2" rad. at one end.....\$4.00

Rotary joint with slotted section and type "N" output pick-up.....\$8.50

Waveguide section, 1 1/2" long choke to cover, 45 deg. twist & 3/2" radius, 90 deg. bend.....\$4.50

Stabilizer cavity feeding waveguide section, with filtered out put and attenuating slugs.....\$20.00

Slug tuner/attenuator, W.E. plated.....\$2.75

TR/ATR Duplexer section with iris flange.....\$4.00

Right angle elbow, 3/2" choke to cover, 2 1/2" radius @ 90°.....\$5.00

Twist, 90 deg. 5/8" choke to cover w/press nipple.....\$5.00

Waveguide sections 2 1/2" long, silver plated, with choke flange.....\$4.50

Waveguide, 90 deg. bend E plane, 18" long.....\$4.00

Rotary Joint, choke to choke.....\$6.00

Rotary Joint, choke to chokes, with deck mounting.....\$6.00

S-curve waveguide, 8" long cover to choke.....\$2.50

Duplexer section for 1B24.....\$10.00

3 cm. waveguide, 1 1/2" x 5/8" O.D. 1/16" Wall.....\$1.50

X Band waveguide 1 1/4" x 5/8" O.D. 1/16" Wall.....\$0.75

Circular Choke flange.....\$0.55

"T" section (TR-ATR) choke to choke, supplied with circ. or sq. flanges.....\$3.50

Directional coupler, CG 124 APS-15A on 16" section cover to cover 15 deg. bend.....\$5.00

Feedback dipole with 90 deg. twist, 7 1/2".....\$3.50

2K25/723AB, X band local oscillator mount with (1) choke coupling to beacon reference cavity; (2) choke coupling to TR and beam; (3) iris coupling with AFC attenuator to antenna waveguide; (4) Radar BFO crystal mount; (5) Receiver crystal mount; (6) Attenuating slugs; Regg. Douglass Budd.....\$22.50

TR/ATR Duplexer section for above.....\$4.00

2 1/2" Flexible section, cover to cover.....\$4.00

Short Arm "T" section, with additional vertical section.....\$4.00

## A COMPLETE LINE OF MICROWAVE EQUIPMENT IN STOCK: 10CM, 3CM, 1.25CM. SEND FOR OUR MICROWAVE FLYER.

## FEDERAL F.T. & R 101-A TWO-WIRE APPLIQUE

Provides necessary balancing facilities for four wire repeater when used on two wire lines which may be voice-frequency telephone lines of open wire, or non-loaded or loaded cable. Std. 19" channel iron rack mtg. Price, new, complete with tech manual.....\$54.00

## EE-89A REPEATER

Extends range of field telephone apparatus, such as EE-8 up to 25 miles, when inserted in a line. New with spare tube and instruction manual, less standard type batteries.....\$21.50

## BC 686 LINE AMPLIFIER

With magneto ringer, 3-tube 2516 amplifier. For local point-to-point telephone operation, remote operation of Phone Xmt., remote reception of receiver output, monitoring facilities. Requires only 24 vac for tube "B" plus supply for full operation.....\$18.50

New, less tubes, in wooden chest.....\$15.50

Per pair for 2-way 10-to-10 operation.....\$35.00

## F.T. & R 102-B REPEATER EE-99

May be used as Terminal or Intermediate Repeater, 20 cycle ringing & DC Telegraph. Applicable on simplex operations. Monitoring facilities, equalizing facilities, Dry or storage battery operation. New.....\$55.00

## A RACK FOR COMPLETE RIG

A professional cabinet for your receiver and transmitter, 46" high, 24" wide, 22" deep. Black crackle finish, 3 decks. Hundreds of useful parts. Below are just a few of the components:

1-11" Jewels  
4-A.C. Outlets  
4-3 Amp RF Meters  
1-40-0-40 Ammeter  
2-Variable Switches  
1-Ohmite Pot.  
5-A.C. Relays  
3-Pulse Blocks  
2-115 VAC. Connectors  
1-Goog  
3-Large Push Button Switches

7-Panel Controlled Circuit Breakers  
4-3 Amp RF Meters  
1-50 amp  
3-Wall Type Switches  
1-Panel Control Switch  
1-Microphone Jack  
3-20 Amp 5-hole Meter Panel  
5-Large Jones Strips  
1-4" 100T Heavy Duty Knife Switch  
1-Control Amplifier

## TOOL KITS

1-200 W. Solder Iron  
1-Solder Paste  
1-Rubberizer  
1-Ledzer  
1-Brush  
1-Rot. Carbon Tet.  
1-#303 Tool  
1-#53-A Tool  
1-#43-A Tool

2-Rolls Solder  
2-Priction Tape  
1-Rotol Roll  
1-Lamp Extractor  
1-Orange Stick  
1-#229 Tool  
1-#265 Tool  
1-Screw Drivers  
1-43-A Tool

Complete Kit, Export Packed, New.....\$12.75

## BAND PASS FILTER

#70473. Sharp band pass peaked at 700 cps. High-to-high impedance. Can be plugged into any circuit without good results. 2-Meter out QIM. New, with circuit diagram.....\$2.25

## CATHODE RAY TUBES

3HP1.....\$2.25 3CP1.....\$3.50  
5HP1.....\$1.20 5CP1.....\$1.35  
5HP1.....\$1.20 3DP1.....\$2.25  
5HP1.....\$2.95 5HP2.....\$8.00

## XMTR TUNING UNITS

From BC 375-525 TU 7 (10-12.5 mc) \$2.25  
TU 22 (430-650 mc) TU 26 (200-500 kc) \$2.25  
TU 22 (430-650 mc) TU 22 (430-650 mc) \$2.25  
For BC 610: TU 48 (2.5-3 mc) TU 52 (4.35-8.5 mc) \$2.25  
TU 58 (18-20 mc) TU 59 (18-20 mc) \$1.75  
For BC 229A: TU 17 (2-3 mc) TU 18 (3-4.5 mc) Each.....\$1.95

## MINE DETECTOR

AN/PRS-1. Can be used to detect buried objects, such as rocks, tree stumps, water pockets, etc. Every homeowner, camper, prospector needs one. Complete unit, consisting of good receiver, antenna amplifier, headphones, meter, resonator, with all necessary cables and tubes, new.....\$12.75

With Batteries.....\$21.65

## BC 1267 XMTR-RCVR.

XMTR consists of tuned line pulse oscillator on 154-186 mc. Can be modified to operate on voice or HF, and put to work on amateur 2-meter band. RCVR. is a superhet with 2 stages of RF and 5 stagger-tuned I.F. stages (11 mc). Plenty of room on chassis for additional components. Used, but in excellent condition.....\$27.50

Complete with power supply for operation from 117 v. 60 cycles.....\$42.50

## ARC-5 ACCESSORIES

CONVERSION COILS FOR ARC-5 TRANSMITTERS

M.O. Coils	P.A. Coils	Loading Coils	Freq. Range
\$1.00 each	\$1.00 each	\$85 each	3-4 Mc.
#6030	#9253	#6034	4-5.3 Mc.

CONVERSION KIT, consisting of 1-M-O coil, 1-Antenna Coil, in any one particular frequency range.....\$2.00

ARC-5 6558 variable coupling capacitor, .52 MFD/section, 3 sections, .037" spacing, 8 rotors. Worm drive ratio 33:1.....\$1.75

ARC-5 4990, variable xmtr. capacitor, .52 MFD/section, .037" spacing, 11 rotors.....\$1.00

ARC9632 Var. Xmtr. capacitor, 29.2-117 mmf., .06" spacing, 16 rotors, worm drive: 96:1.....\$1.00

Single rotor, mtg. racks, \$1.00 each.....\$1.00

DUAL CONTROL BOXES FOR RCVRs.....\$1.00

## HEADSETS

Dynamic mike and head combination. A high quality, efficient unit, used in B-19 tank Xmtrs. Mike and phones complete, new.....\$2.75

R-15 Headsets: 6000 ohm impedance, rubber cushions. Comes with 8' cord and plug PL 55. New.....\$1.95

HT-50 Headset: 2000 ohm impedance, rubber cushions, noise, and low impedance (500 ohms) assures efficiency and fidelity. A MUST for every ham at this price.....\$2.50

Auto match 8000 ohms output.....\$ .35

HEADBANDS: HB-1, HB-4, HB-30, New \$ .25 ea.

## SPECIALS

SELENIUM RECTIFIERS: 115 vac, 115 vac 60 cy. Out: 120 vac, 1.66 amps. Full Wave Bridge, F. T. & R. #111.....\$9.95

SELENIUM RECTIFIERS: 300 vac, 300 vac 60 cy. Out: 24 vac, 1.5 amp. Full wave bridge, GE #8C10.....\$1.50

POWER SWITCH, 4 pos. 60 amps, 600 v. Arrow H&H.....\$4.25

ROTARY SPARK GAP, 24 vac, rotor, 4 spark gap contacts, p/o Xmtr BU 1087-7C.....\$5.50

Code Tape, paper, 1 1/4" wide, 8" diam. rolls.....\$ .50

CABLE ASSEMBLY, 45 pr. 102 L Telephone type WF #D166039, \$20.00 per length.....\$5.00

PHOTOCCELL RCA #932.....\$1.50

SONAR SOUND DETECTOR: Underwater detector with microphone units enclosed in rubber sheath, Model JR.....\$12.50

MNS24 Azimuth control box for aircraft radio compass.....\$5.35

ARC-3 Airphone radio series replacement relays, Types 5524, 5525, 5534, 5538, 5539, 5555, 5548.....\$6.00 ea.

Fuse holder, GE type EI-1.....\$1.00

Amertype Recording Film, 50 ft. lengths, individually boxed.....\$5.35

Modulation Trans. ARC #9466, push pull 807's in Plates and screens of 2 807's in parallel.....\$1.95

## 400 CYCLE TRANSFORMERS

KS 9584, Pri: 115 v. 400 cps; Sec: 5,000 v. 150 ma.....\$12.50

#120533, Pri: 115 v. 800 cps; Sec: 4540 v. 250 ma.....9.95

Plate Xmt. Pri: 115 v. 2800 cy; Sec: 2200 v. 350 volt-amps net.....5.45

KS 9273, Pri: 115 v. 400-2400 cy; Sec: 70-241 v. 247-622 v. 10 amp.....1.35

KS 9445, Pri: 115 v. 400-1000 cy; Sec: 592 vct, 120 ma; 6.3 v, 8 amp, 3 v, 2 amp.....3.50

Plate Xmt. Pri: 115 v. 400 cy; Sec: 9800 or 8600 v. 32 ma.....12.50

Fil. mtr. Pri: 115 v. 400 cy; Sec: 6.3 v, 9 amp; 6.3 v, 67 amp; 2.5 v, 3.5 amp.....3.25

Plate Xmt. Pri: 115 v. 400 cy; Sec: 1550-0-1550 v. 10 ma.....1.75

Plate Xmt. Pri: 115 v. 400 cy; Sec: 600 vct, 36 ma.....1.15

## BEAM ROTATING MECHANISM



**BEAM MECHANISM.** The most useful, powerful, compact assembly offered on surplus for beam rotation. 90:1 gear ratio turned by 24 vac motor that will run on 12 vac. Bicycle type sprocket for easy coupling to any shaft. 9 1/2" x 6 1/2" x 4 1/2". With mounting facility. N.E. warranted, complete with 110 vac to 12 vac step-down.....\$16.50

## DYNAMOTORS

Type	Volts	Input Amps	Output Volts	Output Amps	Radio Set	Price *
BD 77KM	18	40	1000	.350	BC 191	\$12.00 N \$7.95 LN
PE 73	24	19	1000	.350	BC 375	\$8.45 N \$3.45 LN
DM 21	14	3.3	235	.090	BC 312	\$3.45 N \$3.45 LN
DM 21CX	28	1.6	235	.090	BC 312	\$3.45 N \$3.45 LN
DM 25	12	2.3	250	.050	BC 367	\$4.29 LN
DM 28R	28	1.25	275	.070	BC 348	\$5.45 N \$5.45 LN
DM 33	28	7	540	.250	BC 456	\$6.50 N \$6.50 LN
DM 42	28	46	915	1.10	SCR 506	\$5.50 LN
			1050	.050		
			2/8			
PE 55	12	25	500	.400	SCR 245	\$5.25 LN
PE 86 N	28	1.25	250	.060	RC 36	\$3.95 N
PE 101C	18	26	12,676.3	400	SCR 515	\$5.25 N
					9 AC 1 1/2	
RD AR 93	28	3.25	375	.150		\$4.95 N \$3.50 LN
23350	27	1.75	285	.075	APN-1	\$3.50 N \$3.50 LN
35N045B	28	1.2	250	.060		\$4.95 N \$3.95 LN
ZA .0515	12/24	4/2	500	.050		\$4.25 N \$4.25 LN
ZA .0516	12/24	8/4	275	.110		\$4.95 N \$4.95 LN
B-19 pack	12	9.4	275	.110	Mark II	

\* N—NEW; LN—LIKE NEW.

## CERAMIC CAPACITORS

(Eric, Centralab) \$7.50 per 100

3 muf	±5%	67 muf	±2%
5 muf	±5%	100 muf	±5%
4 muf	±5muf	115 muf	±3%
8.5 muf	±5 muf	240 muf	±3%
11 muf	±5%	250 muf	±3%
15 muf	±2.4 muf	250 muf	±3%
48 muf	±2%	500 muf	±15-30%
50 muf	±20%	1000 muf	±5%
60 muf	±3%		

## SILVER-MICA BUTTON CAPACITORS

(Eric, Centralab) \$9.50 per 100

185 muf	±2.5m of
175 muf	±2.5m of
500 muf	±10%

## R.F. COILS

3C4016-7, RF coil Ass'y, 30-40 mc, for revr FMR-13V, \$ .59

2C5395-1206/C2, Antenna Coil, 3.8 to 6.5 mc, iron core for BC 1306 revr.....\$ .45

2C300-457, 22.5 to 25 mc, for Adcock antenna ckt of blasting box. For radio beacon equipment BC 163.....\$1.25

3C302D, RF Antenna coil, 3750 to 3850 kc, p/o BC 654A.....\$ .35

3C351, M.O. coil, 1800 to 2250 kc, plug-in, p/o Collins Xmt 32-RA.....\$1.85

3C350, M.O. coil, 1480 to 1840 kc, p/o Collins Xmt 32 RA.....\$1.85

2C5008A/CS, HF sec coil, bands A, B, C, Revr BU.....\$ .45

2C6032 HA-1/7, RF amp. coil, 9-12 mc, Collins 32 RA Xmt.....\$1.75

2C6900-4/C3, RF amp coil, 1KW, 14, 850-18,000 kc, 3.4 Mchro'ny.....\$2.95

2C4528/9, BFO coil for Super Pro Receiver.....\$ .65

BC 610 Xmt Antenna Loading Unit BC 729-C. Includes variom, loading coil, controlled from front panel, turns indicator, vacuum capacitor (which may be switched in and out of circuit). For coupling to whip antenna from transmitter EC 610. Will handle 600 w. R.F. New, complete.....\$21.50

QBG-1 ECHO RANGING DRIVER-RECEIVER, underwater sound signal transmission and reception unit with range of 200 to 600 yds, and freq. range of 16 to 27 kc. New with battery box in chest, less projector.....\$85.00

## POWER EQUIPMENT

Step down transformer: Pri: 440/220/110 volts a.c. 60 cycles, 3 KVA, Sec. 115 v. 2500 volt insulation. Size 12 1/2" x 8 1/2" x 7 1/2".....\$40.00

PLATE TRANSFORMER, Pri: 117 v. 60 cy. Sec: 17,000 v. @ 144 ma, with choke. Oil immersed. Size: 26 1/2" x 9 1/2" x 13" Amertran type.....\$145.00

Fil. Transformer: Pri: 220 vac, 60 cy, .05KVA, sec: 5 v. 1, 34,000 v. test.....\$24.50

Fil. Trans. UX6899, Pri: 115v 60 cy. Sec: Two 5V.....\$7.50

Plate Transformer: Pri: 115/230 vac., 50-60 cy. sec: 21,000 v. 100 ma.....\$45.00

LINE VOLTAGE REG. Pri: 92-138V 57/63 cy 10H15A Sec: 115V 7.15A .82 KW 96% PE.....\$99.50

Voltage Reg. Transist Amertran type PH 2KVA load. Input 90/130 v. 50/60 cycle output 115 v.....\$40.00

## OIL CONDENSERS

1 mfd. 10 KVDC GEPNR #14F191.....	\$15.00
0.06 mfd. 15 KVDC, GEPNR 25F585G2.....	\$ 8.70
1/5 mfd. 600Vdc ACPW8K.....	\$12.50
23 mfd. 20,000 Vdc.....	\$17.50
10 mfd. 1000 VDC.....	\$ 1.79
3x10 mfd, delta connected synchro-capacitor, 90 v. 60 cy.....	\$ 4.95
1 mfd. 6000 vac, GEPNR 25F585G2.....	\$ 3.85

## POWER CHOKES

Swing. Choke: 4.5 to .8 hv, 2 to 1 amp.....	\$10.95
.03 hv, 2 amp.....	\$1.45
.8 v, 125 mamp.....	\$1.50
.25 hv, 65 ma.....	\$1.10
6 hv, 150 ma.....	\$1.50
Dual 7 hv, 75 ma, 11.....	\$ .95
5 hv, 60 ma.....	\$1.65
Dual 2 hv, 100 ma.....	\$ .75
.116 hv, .15 amp.....	\$1.50
.35 hv, 2.5 amp.....	\$ 7.50
1.25 hv, 130 ma.....	\$ 1.25
4 ohms, 46 ohms.....	\$16.00
50 ma, 80 ma.....	\$ .65
312 ohms.....	\$ .65
200 ma.....	\$ .75
17 ma.....	\$ 2.45

All merchandise guaranteed. Mail orders promptly filled. All prices, F.O.B. New York City. Send Money Order or Check. Shipping charges sent C.O.D.

# COMMUNICATIONS EQUIPMENT CO.

131 "N" Liberty St., New York City 7, N. Y. Digby 9-4124

# INSURE YOUR PROFITS

with 2% PRECISION!



VACUUM TUBE VOLTMETER

MODEL 221

Radical New Design—All Electronic Rectification!

Vastly better than standard copper oxide type. ACCURACY INCREASED to 2% (copper oxide meter reliability, 3-10%). LOADING EFFECT NEGLIGIBLE—1½ megohm load factor on AC compared with low 1000 ohms of copper oxide rectifier. FREQUENCY RESPONSE FLAT to 30 Kc., copper oxide type tapers markedly either side of 60-135 cycles. At lowest cost, you get all this:

- high input impedance—
- 25 megohms
- 15 different ranges—ohms, AC and DC volts
- double triode balanced bridge circuit—extremely stable
- extra heavy duty AC isolation transformer
- linear—2% overall accuracy
- 1000 megohm useful ohmmeter range
- rugged 4½" meter movement—AC and DC on 1 scale—easy to read
- sturdy steel case, portable—genuine leather removable handle
- electronic AC range meter burnout impossible
- individually calibrated scales
- etched panel—scales cannot rub off

**\$49.95**  
NET

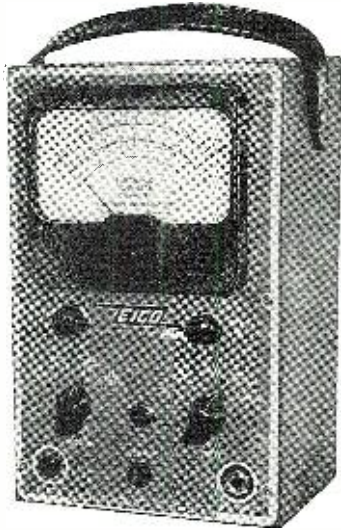

## MULTI-ANALYST

Model 113-A

A complete VTVM that follows signal from antenna to speaker.

- extremely sensitive wide range AUDIBLE signal tracer.
- 6 tubes—gain over 90 in probe ALONE!

With Probes **\$89.50**  
Only... NET

Handy high-gain triode tube probe, available separately. **\$7.90** NET



Ask for SIGNAL GENERATOR Model 315 with exclusive microcycle band spread variable tuning. Accurately align AM, FM and TELEVISION receivers. 7 ranges—75 Kc. to 150 Mc. 1% ACCURACY—all ranges. **\$64.50** NET

If Your Jobber Is Out of Stock, Order Directly from Us, Mentioning His Name

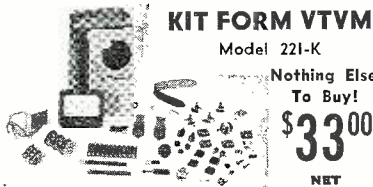

## KIT FORM VTVM

Model 221-K

Nothing Else To Buy!  
**\$33.00**  
NET

Model 221-K is the VTVM described above, in kit form. Includes ALL components. NOTHING ELSE TO BUY! With complete set of 11 stage-by-stage wiring and assembly diagrams and full, simple instructions.

# ELECTRONIC INSTRUMENT CO., Inc.

377 BLAKE AVENUE

BROOKLYN 12, N. Y.

We Welcome School Inquiries—Special Discounts To Quantity Users

## SCHEMATICS—CONVERSIONS FOR SURPLUS GEAR

ARB (CRV 46151), Complete schematic, simplified schematic (both with control boxes), and IF and RF alignment chart. **\$1.00**

BC-645, original & conversion, fixed, mobile. **\$1.00**

BC-375-E step-by-step conversion to AC with power pack. **\$1.00**

AN/ARC-4 with RT-19/ARC-4 & control box, interconnections and cabling diagrams. **\$1.00**

SCR-518-A, 6 large, clear schematics with explanatory notes, frequencies, band-pass and complete reprint of the manual. **\$2.00**

SCR-274-N receivers BC-453, 4, 5; Explanation of control & power circuits & plug terminals. Conversion of front plug to local control adapter with volume control, on-off and CW-MCW switch. AC power. Alignment. Top and bottom parts location views. Voltage & resistance readings. Rack, control box, and interconnection. 12 8½" x 11" pages. Price **\$2.00**

MN-26 receiver schematic, MN-28 control-box schematic and functional diagram, IN-4 left-right indicator schematic, complete interconnection diagram and notes, conversion to 14 V, antenna characteristics, power requirements and tube functions. All for **\$1.00**

BC-348-H, K, L, or R, schematic plus AC power pack and connection instructions. **\$1.00**

BC-348-J, N, Q, schematic plus AC power pack and connection instructions. **\$1.00**

BC-946-B, step-by-step conversion and schematics, pictures, etc. Nothing vague! Delayed AVC and two-stage audio. 12 8½" x 11" pages. **\$2.00**

AN/ARC-5 schematics: low and medium frequency receivers, transmitters, push-pull modulator, and control boxes, plus large schematic of T-23, the VHF transmitter. All for **\$1.00**

SCR-274-N transmitter schematics, including modulator, rack, and control box. **\$1.00**

**SCHEMATICS: \$1.00** Each

SCR-522 ARN-7 BC-433-G BC-733-D

ART-13A APN-1 APN-9 RA-10

APT-2 BC-1206-C R-89/ARN-5A

Please remit with order.

50% DISCOUNT: If you order any four or more items listed in this ad.

**R. E. GOODHEART** 345 ½ N. PALM DRIVE BEVERLY HILLS, CALIF.

## FALL SPECIALS

- 2 Gang—Single Cir. each Deck—12 Pos. .... **29c**
- Single Deck—Single Cir.—11 Pos. .... **22c**
- 3 Gang—2 Cir.—3 Pos. each Gang—Ceramic Non-Shorting SPECIAL. .... **44c**
- 3 Gang—3 Pos.—Single Cir. each Gang—Ceramic Non-Shorting SPECIAL. .... **44c**

### BATHUBS—OIL FILLED ROTARY BAND SWITCHES

- 2 mfd—400 V. .... **19c**
- 2.75-2.75—600 V. .... **29c**
- 1 mfd—600 V. .... **18c**
- .5 mfd—400 V. .... **14c**
- .2 x .2—600 V. .... **14c**



## FAMOUS MAKE CRYSTAL HAND MIKE

with 100 feet of shielded rubber covered cable. Complete with plug. **SPECIAL \$5.95**

### POWER TRANSFORMERS

- 680 V—CT @ 150 V MA—6.3 V—3 AMP—5 V—2 AMP. .... **\$3.25**
- 720 V—CT @ 160 V MA—6.3 V—4 AMP—5 V—3 AMP. .... **\$3.45**
- 800 V—CT @ 200 V MA—6.3 V—3.3 AMP—5 V—3 AMP. .... **\$4.25**

### FILAMENT TRANSFORMER

- SPECIAL 6.3 V @ 1 Amp. .... **79c**
- Special .25—600 V paper capacitor—10 for **\$1.00**
- FILTER CHOKE 15 H—80 MA Surplus. .... **59c**

### SURPLUS POWER TRANSFORMER

- 400 V CT @ 60 MA—6.3 V—3 AMP—5 V—2 AMP. .... **89c**
- 4.3 MC IF Kit—3 IFs—1 Discriminator. All for. .... **\$1.49**
- MICA CONDENSERS .03—600 V working—1200 V. Test. 15c ea. 10 for. .... **\$1.19**

All Mdse. Guaranteed—25% Deposit—Bal. C.O.D.

Send for our NEW FLYER

## AUDIVIEW RADIO PARTS CO.

325 CANAL ST. NEW YORK 13, N. Y.

onance, the impedance presented is capacitive. This latter fact can be understood by noting that for higher frequencies, the parallel condenser offers less impedance than the coil. Consequently most of the current flows through the condenser and the circuit current possesses a leading phase.) Since the audio i.f. frequency of 21.9 mc. is below the 22.9 mc. resonant frequency of  $L_1$  and  $C_1$ , the parallel combination appears inductive to the audio i.f. signal. By resonating this inductance with  $C_2$ , we obtain a series resonant path for the audio i.f. signal and the audio i.f. voltage is bypassed.

By providing a parallel resonant circuit ( $L_1$  and  $C_1$ ) for 22.9 mc., we obtain a sharp rise in voltage just beyond 21.9 mc. Since 22.9 mc. is part of the desired video frequencies (they extend from 26.4 mc. down to 22.4 mc.) we insure that the video frequencies are passed by the trap with negligible attenuation while, at the same time, forcibly suppressing the undesired audio carrier i.f. In the other parallel trap, Fig. 2A, the closely adjacent video frequencies are attenuated to a certain extent, distorting the appearance of the image somewhat.

(e) Bridged-T Traps. A fifth trap, which is more complex than any of the foregoing circuits but also more effective, is the Bridged-T trap shown in Fig. 4.  $L_1$ ,  $C_1$  and  $C_2$  are resonated to the frequency of the signal to be rejected. Now, if the value of the resistor  $R$  is properly chosen, the attenuation imposed upon a signal to which  $L_1$ ,  $C_1$  and  $C_2$  are resonated will be very great. Ratios of 50 and 60 to 1 are easily attainable using components which possess manufacturing tolerances.

Some understanding of the operation of this trap can be obtained if we take the Bridged-T network shown in Fig. 5A and transform it into the equivalent network of Fig. 5B. (This can be readily accomplished with

Fig. 5. The equivalent networks of the Bridged-T circuit shown in Fig. 4.

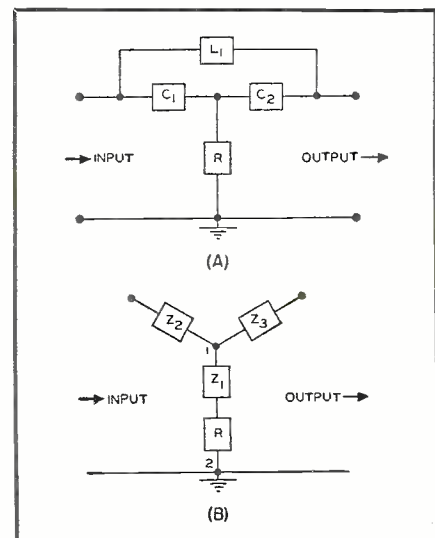

well-known electrical theorems.) If the various components of the Bridged-T network  $C_1$ ,  $L_1$  and  $C_2$  are properly chosen,  $Z_1$  will have a negative value. If we make  $R$  equal to  $Z_1$ , then the total impedance between points 1 and 2 will become zero, effectively short-circuiting signals of the frequency to which the Bridged-T network is tuned. For all other frequencies the trap offers little shunting effect and the signals pass through with negligible attenuation.

### Tuning the Traps

To adjust the traps to their proper frequencies, the following procedure is employed.

1. Connect an AM signal generator having a frequency range from 18-30 mc. to the grid of the mixer or converter tube.

2. Connect a vacuum-tube voltmeter across the load resistor of the video second detector.

3. Set the signal generator to the sound i.f. frequency.

4. Using a neutralizing screwdriver or wrench, change the capacity or inductance of the proper trap until a minimum voltage is registered at the detector. Consult the manufacturer's instructions for the resonant frequency of each trap circuit.

5. Follow the same procedure for each trap, each time altering the signal generator frequency to correspond.

For most television receivers, the traps are adjusted before any video i.f. alignment is begun. During the video alignment process, the traps' adjustment should be rechecked because they are affected to some extent by changes in the associated video i.f. tuning coils and transformers. -50-

## 29 COMPANIES FOLD IN '47

THE RMA Credit Committee, reporting to the organization's 24th annual convention, revealed that twenty-nine radio and component manufacturers failed financially during the last fiscal year 1947-48 with liabilities totaling \$23,912,000.

Ten of these companies were radio set manufacturers, and two were television receiver producers. The remainder produced a variety of radio equipment and parts. Nearly half of these companies started operations during the last five years.

According to E.G. Carlson, Chairman of the Credit Committee, causes contributing to failure included; extensive inventories, excessive plant facilities, unprofitable operations, inadequate distribution facilities, poor quality of merchandise, and inadequate production experience.

Ten wholesalers of radio parts, with liabilities totaling \$556,000, also encountered financial troubles. Sixty percent of these started business within the last five years.

A breakdown of the twenty-nine failures showed: radio receiver, 10; communications equipment, 5; test equipment, 3; television receivers, 2; recorders, 2; radio parts, 2; phonographs, 2; sound equipment, 1; motors, 1; and projection, 1. -50-

September, 1948

# NESCORP ELECTRONICS Presents

### BC-733D

A 10-tube superhet receiver for lateral blind landing guidance (CAA type certificate) (TC-1045) Excellent condition 108-110MC. Tube complement: 1-12SQ7; 2-12SR7; 1-12A6; 1-AH7GT; 2-12SG7; 3-717A—tubes alone worth more than this low price.

EACH.....**\$4.95**  
Schematics Furnished.

### CORD CD-365

6 ft. PL-108 at each end. For use on radio compass to loop.

EACH.....**\$2.50**

### SELSYN INDICATOR

Large 5" model for use with beam rotators. Operates from 15-24 volts. 60 cycles. NEW.....

**\$2.75**

### 1 / WAVE CONANT METER RECTIFIER

A steal at.....

**69¢**

### BATTERY TESTER

A 2" meter 0-6 V. D.C.....

**3 for \$1.00**

### WILLARD 2 Volt Storage Battery

Brand new, spill-proof, use standard electrolyte. Suitable for farm sets and portables. Built-in hydrometer SPECIAL

EACH.....**98¢**

### BC-457

Command Set Transmitter. NEW.....

**\$6.95**

### RM-29

An ideal portable field telephone. Complete in a rugged steel case for years of wear. Ringer circuit and TS-13 handset. No leather case to deteriorate. Compact 5"x6"x9"—also used as remote control on SCR-284. Lt. wt. 13 lbs. Excellent condition. EACH.....

**\$9.95**  
2 for.....**\$18.95**

### BC-458

Command Set Transmitter. NEW.....

**\$6.95**

### T-17B

Microphone Carbon. Like new. A real buy. EACH.....

**89¢**

### WAFER SWITCHES

12 position 3 pole rotary single gang. NEW.....

**4 for \$1**

### LOOP LP-21A

Low impedance, 1 Selsyn motor, 1 selsyn transmitter. Excellent Condition.....

**\$5.95**

### SHOCK MOUNTS

4 each of 3 sizes—small, medium and large. New.

ALL FOR ONLY.....**99¢**

### O-1 M.A.

3" meter—shunt included for 0-10 M.A. use.

NEW.....**\$3.95**

### MIKE ADAPTER

M-299 for SCR-522 permits use of carbon mike. NEW.

EACH.....**\$1.50**

### 6 VOLT MOTOR

A real beauty, removed from aircraft. EACH.....

**98¢**

### 6" PM SPEAKER

Beautiful new stock. Alnico magnet. EACH.....

**\$1.95**

## PLUGS and CONNECTORS

### YOUR CHOICE

for only

**49¢**

each

ALL PRICES F.O.B. CHICAGO

Visit Our New Retail Store

20% Deposit required on all C.O.D. Orders.

### BC-348 BRAND NEW

Enough said!  
EACH.....**\$79.50**

### TU-10B

Tuning unit for BC-375... a terrific parts value with a metal case.

Brand New. ONLY.....**\$2.10**

### CORD CD-370

A six foot head set extension cord with a PL-55 Plug on one end and a jack on the other. NEW.

EACH.....**59¢**

### HOOK-UP WIRE

Approx. 400 ft. assorted gauges and colors—about 2 ft. lengths...

**98¢**

### 6 NO 110 DELAY RELAY TUBE

NEW.

EACH.....**98¢**

### BC-727 INDICATOR BOX

With two red jewel pilot light assemblies. It's a steal. EACH.....

**29¢**

### HEADSETS

HS-23 high impedance, Army Air Force Type, cord and plug, used.

EACH.....**98¢**

### TOGGLE SWITCHES

S.P.D.T. luminous tip bat handle. NET.....

**4 for \$1.00**

### SOLDER

One pound spool, highest grade compound of tin and lead, rosin core, on metal spool. Brand New.

A REAL BUY. Ea.....**69¢**

6 spools.....**\$3.95**

### AN/CRW-2 V.H.F. RECEIVER

6 tubes: 3-6SL7, 1-6SN7, 1-6SG7, 1-6J5. Dynomotor, plug-in coils and sensitive relays. This was one of the Army's "Secret" V.H.F. remote control receivers. A thousand and one uses. Like new in a metal case. Each.....

**\$5.95**

### BC-306

Antenna loading unit for BC-375. Brand New.

Another parts value.....**\$1.50**

### GASOLINE BATTERY CHARGER

12 V. (will charge 26 V. batteries in series) 1 cylinder, used, but good condition. Only.....

**\$35.00**

### CORD CD-605

A two-foot cord with a PL-55 plug; with low to high impedance xformer for your headset.....

**39¢**

### RELAYS

3 asst. 24 V. relays. All for.....

**\$1.00**

### 1625 TUBE Army-Navy Standard

This is a 12 V. filament 807 tube. A tremendous buy. EACH.....

**29¢**

4 for.....**\$1.00**

### GIBSON GIRL

Emergency transmitter complete balloon, kite, generator, case, etc.

New.....**\$29.50**

### BATHTUB CONDENSER KIT

10 assorted for.....

**\$1.00**

### R5ARN/7

15 tube superhet radio compass receiver 100 to 1750 KC; CW—tone-voice. Like new!

AT ONLY.....**\$14.95**

### 5BP1 SCOPE TUBE

Extra special. EACH.....

**\$1.19**

For the SCR-522.....PLQ-167

PL-172

For the BC-733.....PLQ-254

For your 269-F Radio Compass Inverter.....PL-3108-22-4S

For the SCR-274-N.....PL-147, 148, 151,

152, 154A, 156, 258

For the BC-375.....PL-59—PL-61—PL-64

For the ART-13.....U-6U, U-8U, U-10U, U-16U

For the ARC-5.....ARC-9821-9126-9123

Coax Fittings.....PL-258 (83-11)—PL-259A

(83-1SP)—UG-21U—UG-22U

division of

**NATIONAL EQUIPMENT & SUPPLY CO., INC.**

806-816 W. Jackson Blvd. Chicago 7, Ill. FRANKLIN 8629

# FEDERATED TELEVISION SCOOP

on all  
TRANSVISION COMPONENTS

## TRANSVISION Field Strength Meter



an important  
NEW  
Television Service  
Instrument!  
Saves 1/2 the Work  
of Installation!

Numerous features and advantages: (1) Measures actual picture signal strength... (2) Permits actual picture signal measurements without use of complete television set... (3) Antenna orientation can be done exactly... (4) Measures losses or gain of various antenna and lead-in combinations... (5) Useful for checking receiver re-radiation (local oscillator)... (6) 13 CHANNEL SELECTOR... (7) Amplitudes of interfering signals can be checked... (8) Weighs only 3 lbs... (9) Individually calibrated... (10) Housed in attractive metal carrying case.

Transvision Field Strength Meter, Model FSM-1, complete with tubes..... NET \$99.50

## Transvision 13-Channel TV/FM Tuner

Complete 13-Channel  
TV 88-108 Mc-FM

Has 1 stage of RF, three tubes (6BH6, 6AG5, 9002). FM radio range covered by variable condenser, which is also fine tuner for television. Station selector metal plate for 13 channels, and plastic window dial for FM radio tuning. 3" high x 4" long x 2 1/2" wide. Model TF-13, complete with tubes and dial plates.  
..... NET \$34.95

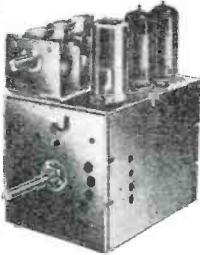

## TRANSVISION All-ANGLE Lenses

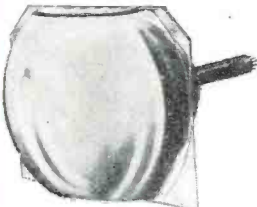

New, Exclusive

Full picture visibility from ANY ANGLE up to 180° with this new, exclusive Transvision lens supplied with Color Filter Kit. Designed by specialists, the ALL-ANGLE Lens gives a high degree of

clear magnification. Increases picture area of 7" tube to 75 sq. in. (equivalent to a 12" tube). With a 10" tube, picture area is close to 150 sq. in. (larger than a 15" tube). Adapter supplied for installation on picture tube.

All-Angle Lens for any 7" tube (gives 75 sq. in. picture)..... NET \$21.95  
All-Angle Lens for any 10" tube (gives 150 sq. in. picture)..... NET \$32.50

We stock all TRANSVISION television and FM components, as well as those of ALL other outstanding manufacturers.

### LAST MINUTE SPECIAL!!

Famous make permanent sapphire phono needle.  
Extra long life. Lists for \$2.50.  
SALE PRICE, Only.....79c

New branch just opened  
1115 Hamilton St., Allentown, Pa.

Please include 25% Deposit with order.  
Balance C.O.D. Minimum C.O.D. Order \$5.00  
DEPARTMENT 28-L

**Federated Purchaser**  
INCORPORATED  
distributors of RADIO-ELECTRONIC  
and SOUND EQUIPMENT  
80 PARK PLACE, N. Y. 7  
Phone: DIgby 9-3050

## Microwave Plumbing

(Continued from page 37)

ingenuity. It only requires that dimensional relationships be correct for the frequency or wavelength employed and the electric and magnetic fields be coupled at the correct point or points for energy introduction or extraction.

The applications for microwaves today are:

1. *Radar* where distant objects much larger than the wavelength effectively reflect sufficient energy back to the transmitting source to give indications of distance and direction on a calibrated cathode-ray tube substituted for a loudspeaker.

2. *Communications and Relay systems* where directivity, channel availability, exceptional bandwidth or pri-

vacuity are desired. It is particularly valuable for channels of exceptional bandwidth as required for broad-band FM, pulsed or contrast (television) forms of modulation.

3. *Microwave Spectroscopy* for absorption studies of gases and liquids too rarefied for analysis by the x-ray or the electron microscope. The individual molecules of gases or liquids are sufficiently large in size with respect to the small wavelengths on microwaves to affect the latter's propagational characteristics in a wave guide. This can be translated into useful scientific or technical information in medical and industrial research.

At the present time, communications and relay systems utilize the lower microwave frequencies while radar utilizes the medium microwave frequencies and microwave spectroscopy utilizes the highest microwave frequencies.

## COLUMBIA INTRODUCES LONG PLAYING MICROGROOVE RECORDS

COLUMBIA Records, Inc. recently introduced a revolutionary non-breakable Microgroove phonograph record which plays 45 minutes on one 12-inch, double-faced record.

The new record, known as the Columbia LP (Long Playing) Microgroove, is capable of reproducing entire symphonies and concertos as well as the complete score of a Broadway musical on a single record. The new Microgroove is also being made available in a 10-inch size with a playing time of 27 minutes.

The secret of the new record lies in the cutting of 224 to 300 Microgrooves to the inch as compared with the 85 to 100 grooves cut into ordinary records; and the playing of the record at 33 1/3 r.p.m. instead of the conventional 78 r.p.m.

Playing the new records requires the use of a special record player capable of providing the 33 1/3 r.p.m. speed needed. Phileco Corporation is manufacturing

and marketing these inexpensive reproducers which may be used in conjunction with any existing radio or radio-phonograph. In addition, Phileco is incorporating this feature in the company's 1949 line of radio-phonographs so that both Microgroove and conventional records may be played. The new phono combinations will have a standard tone arm in addition to the new Phileco reproducer.

The initial LP catalogue of 101 records, including 325 different musical selections, requires only 15 1/8 inches of shelf space for home storage.

Both LP Microgroove records and player are the result of nearly three years of intensive work in the Engineering Research and Development Laboratories of the Columbia Broadcasting System by Dr. Peter Goldmark, Director, assisted by Rene Snepvangers, CBS Recording Engineer and the entire laboratory staff.

Dr. Peter Goldmark, CBS Director of Engineering Research, makes a microscopic examination of Columbia's new Microgroove record with the assistance of Rene Snepvangers, right.

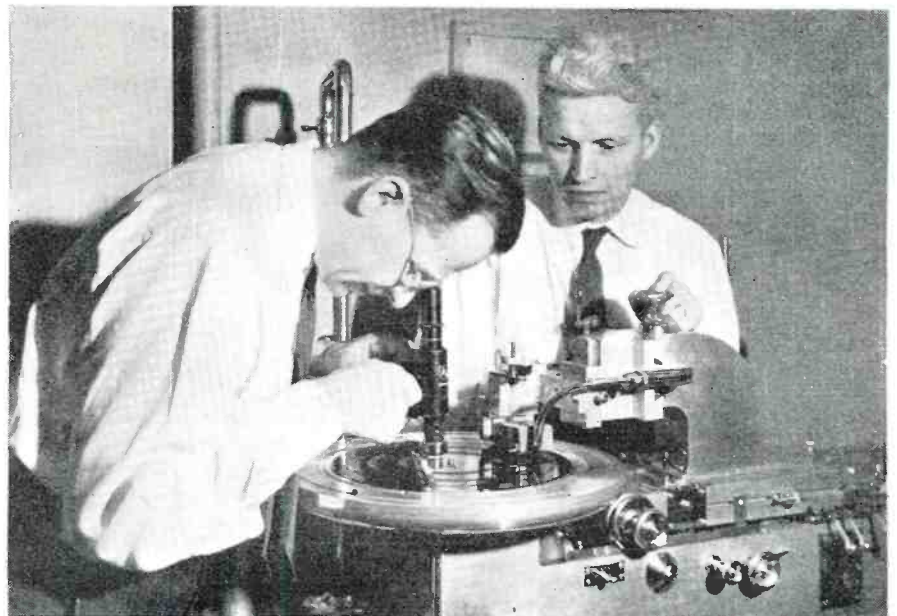

# TUBES! NATIONALLY ADVERTISED BRANDS TUBES!

RCA — Kenrad — Sylvania — Tung-Sol — National Union — Raytheon — Philco — Hytron  
All new tubes, 100% guaranteed individually boxed.

## SPECIAL PURPOSE RADIO TUBES

Cathode Ray		Special Purpose	
3AP1	\$2.95	10Y	\$ .95
3BP1	2.95	3B22	3.95
5CP7	3.95	C6J	3.95
5FP7	3.95	4B24	9.95
7BP7	3.95	531	1.95
9LP7	4.95	717A	.85
12GP7	8.95	864	11.95
		725A	5.95
		730A	1.95
		215A	

## SPEAKERS

4" PM Speaker	\$1.25
5" PM Speaker	1.25
6" PM Speaker	1.98

## SPECIAL! VOLUME CONTROL

1/2 meg with switch .3 for 99c

TERMS: 25% with Order —  
Balance C.O.D.—F.O.B. Chicago  
Prices Subject to Change  
Without Notice

TYPE	PRICE	TYPE	PRICE	TYPE	PRICE	TYPE	PRICE	TYPE	PRICE
O1A	\$.45	3Q5GT	\$.80	6N5	\$.80	6U6GT	\$.65	7C6	\$.65
O2A	.65	3S4	.65	6N7	.80	6U7G	.65	7C7	.65
IA3	.65	3R4GY	1.15	6P5GT	.65	6V6GT	.65	7E6	.65
IA4P	.15	5T4	1.15	6P7G	1.15	6V7G	.65	7E7	.80
IA5GT	.54	5U4G	.45	6Q7	.65	6W7G	.30	7F7	.80
IA6	.96	5V4G	.80	6R7G	.54	6X5GT	.45	7G7	.96
IA7GT	.65	5W4GT	.65	6S7G	.96	6Y6G	.80	7H7	.80
IB4P	1.15	5X4G	.54	6S8GT	.80	6Y7G	.80	7J7	.96
IB5	.96	5Y3GT	.40	6SA7GT	.54	6Z5	1.15	7L7	.80
IC6	.96	5Y4G	.45	6SB7Y	.80	6Z7G	1.15	7N7	.80
IC7G	.96	5Z4	.80	6SC7	.65	6ZY5G	.65	7Q7	.65
ID5G	1.15	6A3	.96	6SD7GT	.65	7A4	.65	7V7	.96
ID7G	.96	6A4/LA	.96	6SF5	.54	7A5	.65	7W7	.96
ID8G	1.15	6A5G	1.15	6SF7	.65	7A6	.65	7X7	.96
IE5GP	1.15	6A6	.80	6SG7	.65	7A7	.65	7Y7	.65
IE7G	1.15	6A7	.65	6SH7GT	.65	7A8	.65	7Z4	.65
IF4G	.80	6A8	.65	6SI7GT	.54	7B4	.65	12A	.45
IF5G	.80	6A87	.96	6SK7GT	.54	7B5	.65	12A5	1.15
IF6	1.15	6AC7	.96	6SC7GT	.80	7B6	.65	12A6	.96
IF7	1.15	6AD6	.80	6SN7GT	.80	7B7	.65	12A7	.96
IG4G	.65	6AE5GT	.65	6SO7GT	.54	7B8	.65	12A8T	.65
IG5G	.80	6AF5G	.96	6SR7	.54	7C1	.96	12AH7	.80
IG6G	.80	6AF6G	.80	6U5/6G5	.65	7C5	.65	12AT6	.65
IH4G	.65	6AG5	.96					12BA6	.65
IH5GT	.54	6AG7	.96					12C8	.96
IH6G	.96	6AK5	.80					12C8G	.65
IJ6G	.96	6AL5	.54					12F5GT	.54
IL4	.96	6AT8	.54					12H6	.54
IL44	.96	6B4G	.96					12I6T	.45
ILB4	.96	6B7	.96					12K8	.80
ILC5	.96	6B8	.96					12SA7GT	.65
ILC6	.96	6C4	.54					12SC7	.65
ILD5	.96	6C5	.54					12SF5	.54
ILH4	.96	6C6	.65					12SH7	.65
ILN5	.96	6C8G	.96					12SJ7GT	.65
IN5GT	.65	6D6	.54					12SK7GT	.54
IN6G	.65	6E5	.65					12SL7GT	.80
IQ5GT	.80	6F5GT	.54					12SN7GT	.80
IR4	.96	6F6	.65					12SO7GT	.54
IR5	.65	6FGT	.54					12SR7	.65
IS4	.80	6F7	.96					12T23	.80
IS5	.65	6F8G	.96					14A7	.80
IT4	.65	6G6G	.80					14B6	.80
IV5GT	.80	6H6GT	.54					14N7	.96
1V	.65	6J5GT	.50					14Q7	.65
2A3	.96	6J6G	.50					14R7	.80
2A4G	1.15	6J6	.96					25L6GT	.54
2A5	.65	6J7GT	.65					25Z5	.54
2A6	.80	6J8G	.96					25Z6GT	.54
2B7	.80	6K6GT	.50					26	.54
2X2/879	1.15	6K7	.54					26A7	1.15
3A4	.65	6K8	.80					30	.45
3B7/71291	.96	6L5G	.80					30	.65
3D6/1299	.96	6L6A	.96					31	.80
3O4	.65	6L7G	.80					32	.96

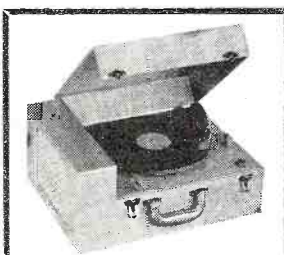

### ELECTRIC PORTABLE PHONOGRAPH

Leatherette Covered. 2 Watt Amplifier. Plays 12 inch records with cover closed. 5 inch Alnico 5 Speaker. Rim drive constant speed. Self starting motor. High fidelity pickup. Size 17"x13"x1 1/2". List Price \$29.95.  
NET PRICE ..... \$15.95  
LOTS OF THREE ..... \$14.95

## FRANKLIN-ELLIS CO. 1313 West Randolph Street Dept. R9 Chicago 7, Illinois

## 1 amp AUTOTRANSFORMER

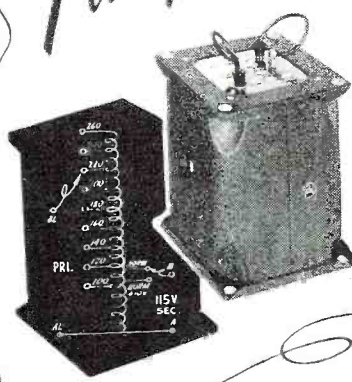

Primary 100 to 260 volts at 1 ampere - 25 to 60 cycles - tapped at 20 volt intervals. Secondary has two taps; one for 115 volt output with normal input; and one for 115 volt output when input is 10 volts high. Example: With 220 volts applied to 220 volt terminal, output is 115 volts at NORM terminal. With 230 volts applied to 220 volt terminal, output is 115 volts at NORM-10V terminal. Can also be used in reverse to obtain outputs of 100 to 260 volts in steps of 10 volts with 115 volts applied to secondary.

Black ripple finish case 3 1/2" x 4 1/2" x 4-7/8" high. Lug terminals on bottom - plug and jack terminal board on top. Made by a well known transformer manufacturer.

Net Wt. 5 1/2 lb. **\$3.95**  
Stock No. B-973B

## 24 Volt 4 1/2 Amp Filament Transformer



Just the thing for the SCR-274N and ARC-5 Transmitters and other surplus equipment. Tapped at 20 volts - six inch flexible leads. Primary 115 volts 60 cycle. Dim: 3-1/8" x 3 3/8" high. Made by one of the world's largest manufacturers. Net wt. 4 1/2 lb.

Using two of these transformers back to back makes an excellent 100 watt isolation transformer.  
Stock No. C-787B **\$2.49**

**NOT ILLUSTRATED**

C-83B T-23/ARC-5 100-156 Mc. VHF Transmitter Brand New with tubes, crystals and diagram	\$19.95
C-24B MT-69/ARC-5 Mounting Rack for the above	\$1.95
B-587B BC-1023A Marker Beacon Receiver - Brand New complete with four tubes, shock mount base and instruction manual.	\$3.49
B-785B Brass Spline for tuning SCR-274N Receivers. 7/32" dia. shaft takes knob or crank w/ 1/4" dia. hole.	.95
B-790B BC-348 Crank Knob	.39c
C-116B Clear Vinolyte Tubing, 1/8" inside dia. 100 ft. rolls. Net wt. 6 oz. Per roll	\$1.49
C-117B 3" Meter Glass with adjusting screw	19c

### Power Amplifier Coil No. 7248

as used in the BC-457 4 to 5.3 Mc. Transmitter. Has adjustable slug tuning, 4-turn variable coupling coil, plate clips and suppressor chokes. Net wt. 6 ozs.  
Stock No. B-683B **19c each**

866 Mercury Vapor Rectifier Hash Filter consisting of an RF choke and resistor in series. Net wt. 2 ozs.  
Stock No. B-692B **29c each**

3-Inch Meter Bracket 2-3/4" dia. hole. 3 1/4" wide x 3-3/4" high. Made of 1/8" brass. Net Wt. 6 oz.  
Stock No. B-767B **29c each**

Filter Choke, 3 Hy, 50 Ma, 325 Ohm as used in the SCR-274N and ARC-5 Receivers. An excellent choke for small power supplies and speech clipper filter circuits. Sealed case 1 1/2" dia. x 1-3/4" high. Net wt. 6 ozs.  
Stock No. B-693B **19c each**

Jack - JK-26 takes the short plug PL-54 as used in Army Headsets, HS-23, etc.  
Stock No. A-317B **19c each**

High Frequency Slug Tuned Coil Form as used in the SCR-522 Receiver. Coil space 3/8" long x 1/2" dia. Excellent for HF converters and receivers.  
Stock No. B-679B **19c each**

1000 Cycle Audio Oscillator RC circuit 1000 cycle audio oscillator using either a 6SK7 or 12SK7 tube. Makes an excellent code practice oscillator, MCW oscillator, test oscillator, or CW keying monitor. Works very nicely with the SCR-274N Transmitters by using the keyed oscillator voltage for your plate supply. Housed in a 2" square x 1 1/2" high aluminum box. Instructions furnished. Price less tube.  
Stock No. C-859B **98c each**

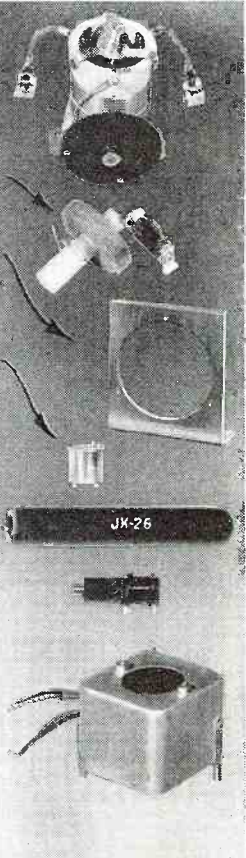

TERMS - cash with order or 20% deposit, balance C.O.D.

STANDARD RADIO & ELECTRONIC PRODUCTS CO. 135 E. Second St. DAYTON 2, OHIO - Tel. FULTON 2174

ALL PRICES ARE NET, F.O.B. DAYTON, O. Minimum Order \$2.00

# High Fidelity RECORDING ACHIEVEMENT...

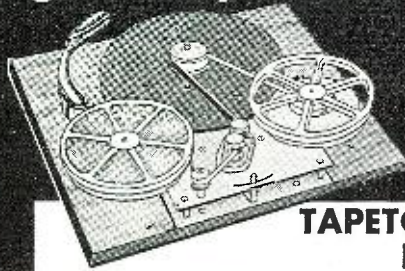

by  
*tapetone*  
in easily assembled  
money-saving kit form!

## TAPETONE MAGNETIC TAPE RECORDING KIT

For Homes, Schools, Studios... Set Builders, Hams, Radio Engineers are all enthusiastic about the newly developed TAPETONE Magnetic Tape Recorder. ● Records voice and music on tape. ● Plays up to 12" platter records and reproduces from the records on to the tape. ● Records radio reception on tape. Tape can be played back and re-recorded hundreds of times.

### THE RECORDING-PLAYBACK MECHANISM

(Illustrated above) comprises heavy duty General Industries motor mounted on rubber, and 10" 3 lb. turntable. Complete tape drive mechanism of exclusive TAPETONE design. Precision tooling with bronze bearings throughout for marvelously smooth quiet operation. Lever has Record-Play, Neutral, and rewind positions. Crystal pickup with permanent stylus. Separate Record-Play and Erase Heads, plug-in type TAPETONE exclusive design. Recording magnetic paper tape is simple to thread and can be edited more easily than home movie film. TAPETONE MAGNETIC TAPE RECORDING MECHANISM, NOW AVAILABLE SEPARATELY, includes; Recording-Playback mechanism illustrated and described above, for 115 Volt 60 cycle AC only; completely assembled plus mounting board; Amplifier wiring diagram; one 1/2 hour roll (1225 ft.) of new SCOTCH HIGH FIDELITY MAGNETIC RECORDING TAPE. Shpg. Wt. 22 lbs

Your net cost **\$62.50**

### THE EQUALIZED AMPLIFIER

This specially designed 6-tube recording and playback amplifier is equipped with exciter circuit for operation with mechanism above. Has high impedance microphone and phono-radio inputs with separate gain controls, permits mixing. Output connects to 4 or 8 ohm speaker voice coil. Supplied in kit form, with all components, tubes, drilled chassis, wire connectors, plugs, cables, nothing else needed — no special knowledge required to construct it. For 115 Volt 60 cycle AC only.



### COMPLETE TAPETONE MAGNETIC TAPE RECORDING KIT

Includes Recording-Playback Mechanism and Amplifier Kit described above, plus one 1/2 hour roll (1225 ft.) of new SCOTCH HIGH FIDELITY MAGNETIC RECORDING TAPE. Shpg. wt. 30 lbs. Express collect.

Your net cost, Complete **\$98.50**

Please include 20% deposit with C.O.D. Orders  
OPTIONAL ACCESSORIES: Crystal Desk Mike with removable base and 7.5 ft. cable... List \$12.20. 8-inch Heavy Duty PM Speaker... List \$8.85. Additional 1/2 hour rolls Scotch Recording Tape, per roll \$3.66 (Plus 15¢ postage when ordered separately)

PORTABLE CABINET FOR COMPLETE ASSEMBLY AVAILABLE

**TAPETONE MFG. CORP.**

37-06 36th St. Long Island City 1, N.Y.

Phone: Stillwell 4-8180

## Surplus Radio Parts

### ALL NEW AND UNUSED

- 45" Tuning Cable for SCR274N, ea. \$ .65
- 72" Tuning Cable for MN26, ARN7, RA10, BC433, ARB, RU16... ea. 1.95
- R/Angle Drive MC211 for SCR274N Tuning Cable, ea. .75... 3 for 1.65
- M299 Adapter—Allows carbon mike to be used on SCR522... 2.95
- 4-foot rubber covered cable for BC375 w/PL61 plugs... ea. 2.00
- DM21M Dynamotor, 12 v input... 1.95

### Plugs & Connectors

- PL103 for BC348... ea. \$ .59
- AN/APN1 Plugs... ea. .39
- R89/ARN5 Plugs... ea. .49
- 733D Localizer plug, straight... .49
- 23 Contact plug for MN26... ea. 1.95
- 16 Contact plug for MN28... ea. 1.50
- PL112, PL118, PL169, PL170... ea. 1.50
- PL173 (less coaxial sleeve)... 1.25
- PL122 for BC433 & ARN7... ea. 1.85
- SCR274N plugs... ea. .75
- PL62, PL65, PL76, PL104, PL108, PL126, PL179, PL256... ea. .49

SPECIAL—Mounting for that mobile rig. FT247 10 3/4" x 8" tray w/4 hvy duty Lord shock mounts, ea. .52... 3 for 1.09

### Mountings & Racks

- FT222, FT228... ea. \$1.00
- FT107, FT142, FT151, FT221, FT225 (same as MT236/ARC3), FT226, FT227 (same as MT238/ARC3), FT229, FT234... ea. 2.00
- FT154, FT293, FT488... ea. 3.00
- FT224, MT14, MT28... ea. 3.50
- FT331A (4 trans. rack)... ea. 7.50

DEALERS—Write for prices.

Minimum order \$2.00—F.O.B. Flushing, N.Y.

**LONG ISLAND RADIO CO.**

Office: 36-23 164th St., Flushing, N.Y.

Store: 164-21 Northern Blvd., Flushing, N.Y.

## TECHNICAL KO's

### OIL FILLED CONDENSERS

.05 MFD 1000 V	\$0.35
.05 500 V	.14
.1 2500 V	.75
.1 7500 V	1.65
2x.1 7000 V	4.10
.12 15000 V	7.95
.25 1000 V	.35
.25 4000 V	2.15
.25 6000 V	3.75
10x.25 600 V	1.05
.5 1000 V	.40
.5 2000 V	.75
.75 2000 V	.60
.77 330 VAC	.30
1.0 1000 V	.45
2.0 200 V	.20
2.0 600 V	.40
2.0 1000 V	.60
4.0 600 V	.60
4.0 1000 V	1.00
5.0 220 VAC	.55
6.0 600 V	.70
6.0 1000 V	1.45
8.0 676 V	.85
8.0 1000 V	1.75
10.0 600 V	1.60
30.0 90 VAC	1.40
30.0 330 VAC	3.75
25.0 25 V	.40
100.0 25 V	.50

### TRANSMITTING MICAS

.000025 2500 V	\$0.15
.00005 2500 V	.15
.00005 3000 V	.35
.00005 5000 V	.85
.000067 2500 V	.20
.00007 2500 V	.20
.00025 2500 V	.25
.00025 5000 V	.85
.0005 2500 V	.25
.00072 5000 V	.85
.0008 5000 V	.85
.001 2500 V	.25
.0011 5000 V	.85
.002 1200 V	.20
.002 3000 V	.65
.00275 2000 V	.25
.003 2500 V	.30
.003 3000 V	.65
.004 2500 V	.35
.005 1000 T.V.	.15
.005 3000 V	.65
.006 2000 V	.35
.008 1200 V	.15
.01 1200 T.V.	.15

### TUBES-CHOKE-POTS

Tubes: 6V6 Metal	\$0.89
Tubes: 12K8 Metal	.29
Chokes: 100MA-10H.	.20
250 Ohm	1.59
Pots: 20K-50K-100K	.19
Dual: 1/2 Meg, 250K-10K	.30

SHIELDED WIRE #22	50 Ft. for \$ .65
RESISTOR KIT ASSORTED 1/2&1W	100 for 1.49
BATHTUB KIT 3x.1, .5, .05, etc.	10 for .58
CONDENSER KIT .01-.00001	100 for 2.99
MICAS .01, .002, .005, etc. ALL VALUES	.08
.01 150V PAPER (MIDGET)	.60 for 1.00
0.1 600V PAPER	.8 for 1.00

\$2.00 min. order F.O.B., N.Y.C. Add postage 50% deposit, balance C.O.D. with all orders. Manufacturers' inquiries invited. Send for Flyer. Prices are subject to change without notice.

## TECHNICAL RADIO PARTS CO.

265 Greenwich St. Dept. RN-4 N. Y. 7, N. Y.

## International Short-Wave

(Continued from page 107)

announcement, "This is the Cable and Wireless Broadcast Station, Nairobi, now closing until 1 o'clock tomorrow" (local time).

**Korea**—Although HLKA, "Voice of Korea," in Seoul, has not been reported to me as having been heard lately, Stockholm Radio reports that in a letter to Block, Belgium, "The Korean Broadcasting System" stated that the station is still operating on 7.935; 5 kw., at 2100-0000, 0300-0900, and 1600-1830 daily. (If any U. S. listener picks up this station, please let me know—at 948 Stewartstown Road, Morgantown, West Virginia).

**Madagascar**—Radio Tananarive, 6.065, has been heard in Australia around 1300 with programs in French; news in French at 1230 and 1330. (DXSA, South Australia) According to a Swedish DX session, frequencies of 10.615, 9.693, and 6.063 are in parallel daily at 2255-0015, 0320-0545, 0900-1345. (URDXC)

**Malaya**—The British Far Eastern Broadcasting Service, Singapore, is scheduled on 6.77 at 0415-1130; 9.69, 0600-1130; 11.73, 0415-1130; and 15.30, 0415-1630. All are 7 1/2 kw. News is scheduled for 0600, 0645, 0800, 0915, 1000 (Radio Newsreel relayed from EBC, London), and 1100. Most programs are now taken from the BBC (General Overseas, Far Eastern, or Eastern Service).

**Mauritius**—By now the Mauritius Broadcast Station should be running tests in French on approximately 7.295; exact time for tests is not known but the medium-wave outlet is scheduled 2200-2245, 0315-0350, 1000-1230. (Southall, Pa.)

**Mexico**—At 2345 the news is read (in English) from XEBT, 9.625, Mexico City; broadcast is sponsored by Mexico City Herald; station is fine level in Chicago. (Domzalski) However, URDXC reports the news daily at 2230, except Thursdays when it is at 2000.

XEWV, Mexico City, is again noted on 9.500; for a while was higher. (Balbi, Calif.)

**Mozambique**—CR7BJ, 9.654V, Lourenco Marques, signs on at 0000 (at least on weekdays) with good level; easily identified by rooster call, bells, and selection "Dawning" from Grieg's "Peer Gynt." (Southall, Pa.)

Lourenco Marques is heard on West Coast on approximately 9.727 at 0700-1000. (Dilg) Also reported by Balbi, Calif., with QRM from XGOA's 9.730 to 0915 when the Chinese station leaves the air; Balbi lists call of CR7BE. Announces will return at 6 P.M. (local time) on 60 and 85 meters.

**Northern Rhodesia**—A time check on the quarter hour from "This is Lusaka calling" is an excellent cue to identify ZQP, Radio Lusaka, 3.910, according to Stephen, South Africa; reports are verified by pretty card;

scheduled 0400-0530, 1000-1200; QRA is Information Officer, P.O. Box 209, Lusaka, Northern Rhodesia. (Stockholm Radio)

ZQP's 9.710 outlet is usually a poor signal now in England around 1100-1200; has bad QRM from both Leipzig and Moscow; gives weather forecast 1155, time at 1200 as 7 p.m. (in Lusaka); closes with National Anthem. Lists schedule as 1000-1200 daily (1030-1130 Sundays) on 9.710, 7.220, and 3.914; and on Sundays also at 0400-0530 (this is a special transmission to Europeans). (Pearce, England)

Norway—In the daily overseas beam from Oslo at 2000-2100, frequencies of 9.610, 11.735 (reported 100 kw.), and 15.17 are now used; however, since 15.17 is much better than 11.735 in East, it is believed that the 100 kw. transmitter is being used there instead of on 11.735; uses some *English*. (Dunham, North Carolina) Stark, Texas, and others report similar reception and such is the case here in West Virginia.

Palestine—Some time ago Herbert Bluman, Eritrea, informed *Radio Australia* it was believed the Sharq-al-Adna transmitters had been moved from Jaffa to Amman (Trans-Jordan). At that time Mr. Bluman was hearing the 11.720 and 6.790 channels at 0330-1400. Pearce, England, still hears the 6.790 outlet with Arabic to 1400; says some DX-ers believe moved to Cyprus.

Panama—HP5K, 6.005, Colon, has *English* 2115-2145. (Peddle, Newfoundland) Lists schedule as 0600-2300. (Pearce, England)

Peru—"Radio America," OAX4W, 5.905, and OAX4V, 9.380, are both heard with good strength in New Zealand to 0000; "Radio Delcar," OAX1A, Chiclayo, has moved to 6.715 and signs off daily 2330; "Radio Continental," OAX6E, 6.330, Arequipa, is mixed with HI1Z, Dominican Republic, and signs off 2355. (Cushen, via Stockholm Radio)

An official of OCW4, Lima, has notified Kary, Pa., that the transmitter he heard was a Bunnel 26-2, employing an 880 in the final (20 kw. dissipation, water-cooled triode) modulated by push-pull Class AB1 889R, 5 kw. air-cooled triodes. The nominal carrier is 15 kw., although its present (telephone) service is normally rated per peak output, or 60 kw. (on modulation crests). The transmitter is essentially designed for short-wave broadcast service, and was originally intended for shipment to Russia on lend-lease during the war, but was diverted to Lima upon termination of hostilities. They use a rhombic antenna directed on Netcong, New Jersey, the main receiving site for A. T. & T. long-lines department, the North American telephone outlet. Modulation is maintained at a high level automatically by a VOGAD (Voice Operated Gain Adjusting Device) in the control terminal, and overmodulation (to handle peaks of short duration which escape action of the VOGAD) is eliminated by use of a limiting amplifier at the trans-

## TELEVISION SPECIALS

### DEWALD TELEVISION No. BT 100

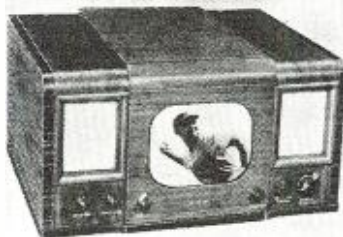

- Tubes—27 plus 3 rectifiers
- All 13 Channels
- 10-inch direct view picture
- Simplified Audio-Video controls
- Safety high voltage supply
- Superb tone quality
- Excellent picture contrast
- Full FM Audio Circuit
- Balanced Antenna input circuit

LIST \$375

(write for DEALER NET PRICE)

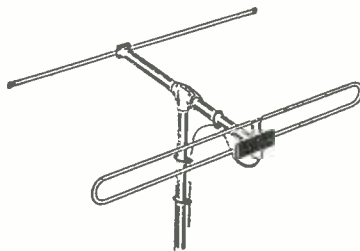

### OAK RIDGE TELEVISION ANTENNA

- Folded dipole with reflector
- High gain broad band performance
- High rejection ratio to interference
- Matches 300 OHM transmission line
- Simple assembly
- Instructions included

LIST \$15.60 Your cost \$963

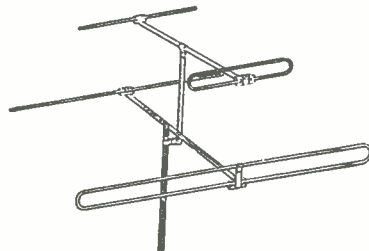

### PHILSON ALL WAVE TELEVISION ANTENNA

All features sought for available in one complete unit, takes in all 13 channels both high and low frequencies, instructions included.

LIST \$25.00 Your cost \$1475

### TELEVISION I.F. KIT

- Video & Sound I.F. System
- Including peaking coils
- Stagger tuned
- H.I. Definition picture
- 4—M.C. band width
- Sound rejection 150 to 1
- Adjacent channel rejection 100 to 1

LIST \$19.95 Your cost \$1197

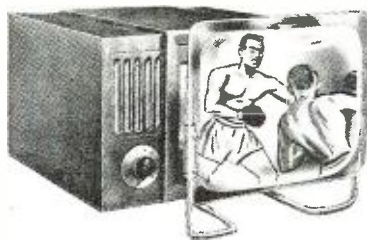
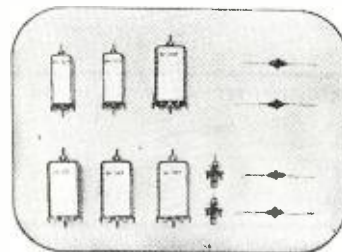

### MAGNAVIEW TELEVISION MAGNIFYING LENS

- Fits all Table and Console Models
- For use with any 10- or 12-inch receivers
- Enlargement up to 4 times
- Wide angle view
- Easy to attach

LIST \$29.50 Your cost \$1750

TWIN LEAD-IN WIRE, 300 ohms, 100 feet.....\$ 1.95  
 " " " " " , 500 feet..... 7.50  
 " " " " " , 1000 feet..... 13.75

COAXIAL CABLE (RG59U), 72 ohms, 100 feet.....\$ 5.25  
 " " " " " , 500 feet..... 24.75  
 " " " " " , 1000 feet..... 47.40

CATHODE-RAY TUBE, NO. 7EP4.....\$17.40  
 " " " 10BP4..... 34.50

BROOKS RADIO DIST. CORP., 80 Vesey St. (Dept. B) New York 7, N.Y.

# HERBACH & RADEMAN

presents

## OUTSTANDING VALUES FROM THE PAGES OF "THIS MONTH"

Shown here are just a few of the hundreds of values listed in our monthly bulletin, "THIS MONTH." Copies of this bulletin can be had by merely sending us your name and address.

### WIRE BUY OF THE YEAR

Twisted pair "Intercom" cable at less than 1¢ per ft. Each conductor is size 22 AWG solid tinned copper with a .025" thick cover of heavy rugged durable plastic. Twisted pair is colored red and gray.  
Cat. No. RN1189—100 Ft. 1000 Ft.  
Coil.. **90¢** Spool.. **\$7.50**



### DIRECTION FINDER ADAPTER

Navy Type DU-1. Designed to take unilateral and bilateral bearings. Use with any receiver covering 200-1600 KC range (or any part thereof). 3 band coverage: 200-400, 400-800, 800-1600 KC. Consists of a loop RF amplifier & sense antenna RF Amplifier. Provides a figure 8 bearing or a cardioid bearing to give both direction and compass bearing. Easily connected to your present receiver. Furnished with instructions. New—in original factory packing. Shng. Wt. 7 lbs.  
Cat. No. RN1041..... **\$29.50**

### BODINE SYNCHRONOUS MOTOR

Just one of the 50 some odd motors listed in the current issue of "THIS MONTH" is this reversible synchronous 115V-60 cycle capacitor start unit by Bodine. Speed 1800 R.P.M., 1/40 H.P. Motor body measures 4 1/2" dia. x 5 1/4" L. Bronze casting on 1 end. Supplied with starting capacitor. Shng. Wt. 20 lbs.  
Cat. No. RJ1165..... **\$13.95**

### PRECISION FERRULE METER MULTIPLIERS

For use as series resistors with D.C. Voltmeters having a sensitivity of 1000 ohms/V. or wherever 1/2% of 1% accurate resistor is required. Made by Weston, Sprague, IRC, etc.

Cat. No.	Resistance	Length	Price
RN911	1.5 Meg.	5-9/32	\$ 1.95
RN5230	2.0 Meg.	5-9/32	2.95
RN913	3.0 Meg.	5-9/32	3.95
RN514	4.0 Meg.	9-23/32	3.95
RN1136	20.0 Meg.	30 1/2	14.95

### THORDARSON "HI-FI" LINE TO GRID TRANS.

Taken from new equipment. Grounded electrostatic shield, hum bucking construction. Hi-permeability magnetic shield, vacuum impregnated. Two identical balanced 225 ohm primaries, secondary 50,000 ohms. Inverted mounting, stud terminals. Size 1 1/2" dia. x 2" H.  
Cat. No. RN1127 Lots of  
EACH..... **\$1.95** 10 or more **\$1.50** EA.

### BLOWER

Heavy duty capacitor start 1/40 H.P.—3400 R.P.M. 115V-60 cycle motor with a Type 00 SIRCOCO Blower. Displaces 84 c.f.m. Extremely quiet operation. Furnished with starting capacitor. Shng. Wt. 13 lbs.  
Cat. No. RN1115..... **\$14.95**

### HEAVY DUTY DYNAMOTOR

P.M. Field Type dynamotor with 3 windings. (1) 6.3V @ 2A. (2) 25V @ 1.7A. (3) 200V. @ .03A. Can be used on 6.3V to supply 25V, and 200V... or on 25V... to supply 6.3 and 200V... completely filtered. Supplied in steel case—size 6" x 9" x 4". Shng. Wt. 16 lbs.  
Cat. No. RN1022..... **\$1.89**

### HIGH INTENSITY HORN

Navy Type H4 115V-60 cycle Buzzer—diaphragm Electronic Horn. Volume of sound sufficient for inside or outside use as a fire alarm, burglar alarm, factory horn, or wherever high level output is needed. Size 6 1/2" dia. x 6 1/2" deep.  
Cat. No. RN1109..... **\$6.95**

Order direct from this ad, and be sure you send us your name for our mailing list.  
Terms 20% deposit, balance C.O.D.  
All prices quoted F.O.B. Warehouse, Philadelphia, Pa.

**HERBACH & RADEMAN, Inc.**  
Electronics Specialists  
522 MARKET ST., PHILADELPHIA 6, PA.

mitting site. Many frequencies and calls are available.

*Philippines*—KZOK, 9.692, Manila, is heard in Australia at 0430 with *English* program of news and music. (Sanderson)

The 25-m. band outlet of KZFM, Manila, appears to be 11.845; uses commercials; mentions four frequencies, believed to be 6.170, 9.570, 9.615, and 11.845 (may announce 11.840); now signs off 1000. (Dilig, Calif.)

KZBU, 6.10, Cebu City, is again being heard in California around 0412, fair level; on Sundays carries such programs as "Lutheran Hour"; has commercial announcements, including the "singing variety" so common in U. S. medium-wave broadcasting.

*Portugal*—CS2MP, 12.750, Lisbon listed 500 w., is good at 1630. (Southall, Pa.)

Peddle, Newfoundland, says CSW, 6.374, and CSW7, 9.730, Lisbon, are parallel, heard at 1900-2030 beamed to Western Hemisphere.

*Siam*—Bangkok is operating on approximately 7.120, heard from around 0330 to 0800; also operates on approximately 6.000 (listed 5.994). (Descuza, Singapore, via Radio Australia) Latter frequency has *English* news 0615, fair level in Australia. (Sanderson)

*South Africa*—Cape Town's 5.878 outlet relays BBC news at 0100; fair level in Kentucky. (Alcock)

ZRB, 9.110, Waterkloof Aerodrome, Pretoria, is heard in Newfoundland, mostly relaying SABC, at 2345-0100. (Peddle)

*Spain*—Madrid's 9.369 is one of the best signals in the 31-meter band in New Zealand around 2100. (Clark) Has news daily 1500; on printed programs sent out says that on Sundays radiates a short news bulletin at 1446-1452, following a concert of Spanish symphonic music; lists daily transmission to Hispanic America as 1845-2200. (Boice, Connecticut)

*Spanish Morocco*—Radio Tetuan, 6.067, is heard in England around 1500-1700; relays news in Spanish from Radio Nacional de Espana, Madrid, at 1545. (Pearce)

*Radio Australia* reports Sumatra outlets of 10.570, 7.455, and 4.615 (announced) as scheduled 1830-2030 (news 1915), 2330-0030, and 0430-1000 (news 0645, 0715).

*Tangier*—Radio International, 6.200, is good strength in New Zealand 1500 when *English* session is given. (Clark)

*Turkey*—By this time the projected 100 kw. station at Istanbul should be testing. Eventually, it will be beamed to the Americas, Far East, Australasia, Africa, and Western Europe; probably will use wavelengths of 41.19, 32.89, 25.25, 19.78, 16.87, and 13.85 meters (roughly frequencies of 7.31, 9.125, 11.875, 15.195, 17.78, and 21.66). (If tests are heard, please notify me at 948 Stewartstown Road, Morgantown, West Virginia, U.S.A.)

TAQ, 15.195, Ankara, is broadcasting to the U.S. (in *English*) fortnightly on Tuesdays at 1700. (Nilsson, Sweden) This outlet has replaced

# ATTENTION, HAMS!



NEW TRANSFORMERS FOR THAT NEW RIG also TRANSFORMERS TO OPERATE THAT SURPLUS JOB

### TRANSFORMERS & CHOKES

- Sec. 3000-0-3000 volt 500 ma. Prim. **\$39.95**  
115/230 volt 60 cy. ....
- Sec. 2000-0-2000 volt 500 ma. Prim. **\$28.95**  
115/230 volt 60 cy. ....
- Sec. 1500-0-1500 volt 500 ma. Prim. **\$20.95**  
115/230 volt 60 cy. ....
- Sec. 375-0-375 volt 250 ma. 12-12 or 24 volt—3 amp. 5 volt 3 amp. Prim. 115 volt. **\$6.50**  
60 cy. (BC-696) .....
- Sec. 250-0-250 volt—50 ma. 12-12 or 24 volt. 6.3 volt (6X5) Prim. 115 volt. 60 **\$2.90**  
cy. ....
- Sec. 14-14 or 28 volt 7 1/2 or 15 amp. **\$3.95**  
Prim. 115 volt 60 cy. ....
- Autotformer—14-14 volts. 7 1/2 amps. sec. **\$2.79**  
115 volt 60 cy. Prim. ....
- Choke 5-20 h. 500 ma (swinging) 5000 **\$7.95**  
volt test .....
- Choke 8 h. 500 ma (Filter 5000 volt **\$8.25**  
test) .....
- Choke 5-20 h. 400 ma (swinging) 5000 **\$11.50**  
volt test .....
- Choke 8 h. 700 ma (Filter 5000 volt **\$12.25**  
test) .....

All Voltages are DC full load output

### POWER SUPPLIES

- Complete 600 Volt 250 Mil DC Power Supply with 12-12 Fil Windings. For 696 and 274 N units ready to connect. 115 volt. 60 **\$20.00**
- Power unit with 4" speaker for ARC-5 Receivers. ready to connect. .... **\$9.95**
- DC Power Unit 12 1/2 Volt, 16 amp. or 25 Volt 8 amp. complete filtered. .... **\$38.50**

Write in for special price on 1500 Volt, 2000 Volt and 3000 Volt complete DC Power Supply with Exciter Supply.

Write for Quotations on Special Transformer not listed. All New Units, NOT Surplus, All Guaranteed.

## POWER CONVERSION CORP.

364-A SOUTH MERIDIAN ST. INDIANAPOLIS, INDIANA

Save Time—  
Save Money

Whatever you need in the way of Radio Equipment can be found in this month's

### CLASSIFIED SECTION

## CLEARVUE SMALL PARTS FILE



Keep your precision tools, resistors, condensers etc., in clear

ANY BOX REMOVED LIKE A BOOK FROM THE SHELF

durable plastic file boxes. Tight fitting covers keep our moisture, rust and dirt. Boxes set at convenient eye angle in bright metal stand. Each box 4 3/4" x 4 3/4" x 1 1/8"

- 10 Boxes with stand..... **\$2.98**
- 10 Boxes without stand..... **2.50**
- 5 Boxes without stand..... **1.35**

Postpaid. Send Check or Money Order. No C.O.D., please.

CLEARVUE CO. 6235 So. Manhattan Place Los Angeles 44, California



# TRIODES... All Triodes for True High Quality Audio Performance

**New!** Brook Model 10C3—Remote control amplifier with both high- and low-gain inputs for all types of tuners and pickups.

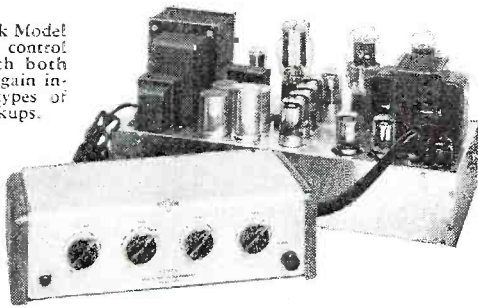

THE BROOK ALL-TRIODE AMPLIFIER is built with only one objective... to provide the cleanest possible reproduction of fine music.

Its frequency response is flat within 0.2 DB from 20 to 20,000 cycles—intermodulation and harmonic distortion are reduced to negligibility.

Although its "paper performance" surpasses that of any other amplifier, the Brook must really be heard to be fully appreciated. When you hear the Brook alongside other amplifiers—any amplifiers—you are in for an experience which is both surprising and enlightening.

Write Today for Distortion Analysis and Technical Bulletin RJ-8!

## The BROOK High Quality Amplifier

— Designed by LINCOLN WALSH



BROOK ELECTRONICS, Inc.,  
34 DeHart Place, Elizabeth 2, N. J.

# Are YOU Fixing Radios this New, EASY Way?



AMAZING—SENSATIONAL—NEW FM AND TV CATHODE-RAY STETHOSCOPE

Think of it! Actually many instruments in one including a complete 2" oscilloscope and stethoscope. This high quality instrument has been designed for FM and Television servicing and is ideal for AM and audio work, too. Only by utilizing the most advanced circuits can FEILER offer the CATHODE-RAY STETHOSCOPE at this amazing low price. The C-R STETHOSCOPE will permit you to SEE and HEAR the signal at the same time. The newly designed STETHOSCOPE probe, an extra feature not found in other instruments will enable you to solve many of those "impossible" problems in a matter of minutes. The 28-page technical manual, "The Inside Story" tells you all about the C-R STETHOSCOPE. Send coupon today. Learn how you can obtain this remarkable new instrument at the amazing low price of **\$89.95**

(Less headphones and probe.) Dimensions: Length 17 1/2", Height 14 7/8", Width 9 1/2". Ship. Wt. 33 lbs.



## Remarkable new "STETHOSCOPE" Method Guaranteed to Lick Toughest Jobs!

Why let old-fashioned methods and equipment hamper your servicing ability? Thousands of radio servicemen—many with little experience—are already fixing radios this remarkable "automatic" way. It's as simple as A.B.C. because STETHOSCOPE SERVICING is the newest, most basic method yet devised to simplify all repairs. STETHOSCOPE SERVICING is guaranteed to speed-up and improve your servicing ability or your money will be refunded. You owe it to yourself to find out how you, too, can begin cashing in. Don't delay—send coupon today.

**OTHER MODELS AVAILABLE.** STETHOSCOPES come in all sizes and price ranges from \$9.95 to \$89.95. There is a STETHOSCOPE to meet every need—to fit every pocketbook. AMAZING "INSIDE STORY" YOURS!

**CONTAINS SERVICING HINTS AND TIPS.** A new, complete illustrated 28-page technical manual tells the inside story of an amazing new servicing method—also contains many valuable hints and kinks for every radio serviceman. Send 10c in coin or stamps to cover handling.



DON'T DELAY! SEND COUPON TODAY!

FEILER ENGINEERING CO., Dept. 9H8  
945 George St., Chicago 14, Ill.  
Please rush new manual "The Inside Story." I enclose 10c to cover handling.

Name .....

Address .....

City ..... State .....

Everybody agrees ATR AUTO RADIO VIBRATORS are TOPS



AUTO RADIO VIBRATORS have Ceramic Stack Spacers

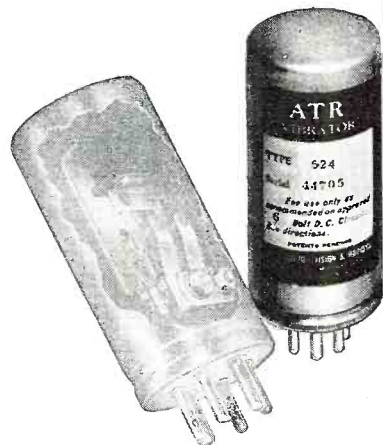

New 34 page VIBRATOR GUIDE FREE

A Complete Line of Vibrators . . . .  
Designed for Use in Standard Vibrator-Operated Auto Radio Receivers. Built with Precision Construction, featuring Ceramic Stack Spacers for Longer Lasting Life.  
Backed by more than 17 years of experience in Vibrator Design, Development, and Manufacturing--  
ATR PIONEERED IN THE VIBRATOR FIELD.



### New Models



"A" BATTERY ELIMINATORS For DEMONSTRATING AND TESTING AUTO RADIOS

### New Models



STANDARD AND HEAVY DUTY INVERTERS

New Models . . . Designed for Testing D. C. Electrical Apparatus on Regular A. C. Lines. Equipped with Full-Wave Dry Disc Type Rectifier, Assuring Noiseless, Interference-Free Operation and Extreme Long Life and Reliability.

For Inverting D. C. to A. C. . . . Specially Designed for operating A. C. Radios, Television Sets, Amplifiers, Address Systems, and Radio Test Equipment from D. C. Voltages in Vehicles, Ships, Trains, Planes and in D. C. Districts.

NEW MODELS NEW DESIGNS NEW LITERATURE See your folder or write factory

AMERICAN TELEVISION & RADIO CO. Quality Products Since 1931 SAINT PAUL 1, MINNESOTA-U.S.A.

LOW COST — QUALITY

# TELCO TELEVISION TOWERS

SIMPLICITY OF ERECTION

- Light weight (2½ lb. per foot approx.)
- Sturdy all welded construction
- High tensile steel tubing
- Sections easily joined with coupling sleeves supplied
- Ten and twenty foot sections completely assembled, ready to erect



WRITE  
PHONE  
WIRE



## Points to remember about Telco Tower

Comes completely assembled, heavily coated with outdoor asphalt aluminum paint. Antenna mounting to your specifications. Stock sizes available to accommodate TELEBEAM-V-DEE-X, and Workshop Associates antenna. Exhaustive factory tests, research by structural engineers have proven Telco Towers to be sturdy and sound in winds up to ninety miles per hour with an antenna which exhibits one ton wind resistance at that wind velocity. Varieties of bases available.

Descriptive literature and specifications upon request.

\*TRADE MARK  
PAT. PEND.

## TELEVISION LABORATORIES, INC.

1408 WILMINGTON AVE.

P. O. BOX 929

NEW CASTLE, PENNA.

EXCEPTIONAL OPPORTUNITY FOR RECOGNIZED JOBBERS

**NEW!!**

**PATENTED SOLDERING IRON TIP**

**WILL LAST 6 MONTHS**

**HEATING TIME 9 SECONDS**

Scientifically Designed for long use without Breaking or "Eating Through." Made to last, these Electrodes will amaze you—with the wide variety-of-uses to which they can be put. Heat generated is sufficient to cover soldering needs of the every-day work in your shop - - - - - No Need for Heavier Irons.

**NOTE:**

NO DAMAGE CAN RESULT TO THE TRANSFORMER AS LONG AS THESE ELECTRODES ARE USED WITH SAME CARE EXERCISED WITH THE USE OF ANY OTHER WIRE OR ELECTRODE.

Each Electrode is Guaranteed for 6 Months except against misuse or breakage caused by carelessness.

SALE PRICE Net .65 each  
at your Jobber or Dealer - - EVERYWHERE

INQUIRIES INVITED  
From Mfgs.-Reps.  
and Distributors

### CAL-PERRY Corporation

62 FRANKLIN ST.  
EAST ORANGE  
NEW JERSEY

TAP, 9.465, for the Sunday *Postbag* period at 1530 (in *English*). Is also heard daily around 1600-1615 in what appears to be Balkan languages. Peddle, Newfoundland, reports TAQ is also used widely to BBC and to New York. Ankara wants reports on TAQ, according to Pearce, England.

USSR—Moscow's Home Service opening at 2200 is audible in Chicago on 15.41, 15.39, 15.34, 15.28, 11.948, 11.900, 11.78. Moscow is heard to Latin America, 2200-2230, on 11.63, 11.890, 11.96; probably uses other channels as well. Moscow is heard on 15.440 with *English* to Great Britain at 0900; German at 0930 to 1000 sign-off; back again 1030 with program in Central or Eastern European languages; 1100-1200 in German ("Moscow Rundfunk in Deutscher sprach"); 1200 in French ("Ici Moscow"); and 1230-1330 again in *English* to Great Britain (news 1230-1245). (Gutter, Illinois)

Prior to opening of the North American beam at 1820, *Radio Moscow* is heard on 11.96 in a Germanic language at 1745-1815; *may be Icelandic?* (Worris, N. Y.)

A Soviet outlet on 9.38 is heard in California beamed to Orient from 0400 on. (Balbi)

Frequencies now announced by Moscow for North American daily beams are 17.83, 15.41, 15.39, 15.17, 11.88, 11.87 at 0745-0815; 11.96 and 11.71 at 1820-1950, and 15.39, 15.23, 11.96, 11.88, 11.87, 11.71 for between 1820-1930. (Jeffrey, Indiana)

Venezuela—Schedule of *Radio Cabimas*, 6.150, Cabimas, is 0430-0630, 0930-1130, 1530-2030; uses a Willcox transmitter and power of 4 kw.; antenna is single-wire type. (Nilsson, Sweden) Station is located on shore of Lake Maracaibo in important oil-producing center of Cabimas. (Johansson, Sweden)

YV5RY, *Radio Continente*, Caracas, has been heard in both the 63- and 31-m. bands, but announcing *only* the frequency of 4.725; in a letter to Chavez, Cuba, station advised his report on 63- and 31-m. outlets was correct but on letterhead they listed only frequency of 3.380; signals are strong in Havana and usually they sign off at 2230 with the Venezuelan National Anthem; QRA is Apartado 866, Caracas, Venezuela.

Yugoslavia—YUA, 6.107, Belgrade, still has news 1530. (Peddle, Newfoundland)

\* \* \*

### Last Minute Tips

Arthur, West Virginia, reports "WRA11, 18.494, RCA, Tangier, has been at excellent level around 0900, relaying 'Radio Tel Aviv,' Israel, to WQD2, New York; the Tel Aviv station is apparently an emergency job whipped up by an RCA technician on the spur of the moment; all work appears to be network pick-ups and personal messages; could not locate 'Radio Tel Aviv,' nor could I locate its Tangier contact, WRA5."

Peddle, Newfoundland, reports ZCB,

RADIO & TELEVISION NEWS

approximately 15.490, Tel Aviv, Israel, has been heard contacting New York at 0915-0955. Kary, Pa., informs that frequencies and calls in use by RCA stations located at Tel Aviv (under jurisdiction of the Postmaster General, Dept. of Posts & Telegraphs, of the Israeli Government) are ZCA, 18.890, ZCB, 18.350, and ZCC, 14.700.

Dilg, Calif., reports that more recently XGOE, Kweil., China, appears to be on 9.825, instead of assigned 9.820; on 9.820 there is harmonic of the Japanese outlet on 4.910, he explains.

Batavia, Java, 13.345, more recently has been running to 1400 sign-off; English at 1200. (Fuller, Rhode Island)

A new Communist-controlled Chinese channel appears to be on about 9.385; relays XNCR and may be XGNC, formerly on 6.563; woman announcer gives several frequencies when announcing, but readability of this station is too low to copy. (Dilg, Calif.)

Kary, Pa., reports *Radio Espana Independiente* on a new frequency of 17.280, fair signal at 1235, minimum of jamming noted.

Ken Dobeson, England, reports a new Spanish transmitter heard testing in the 20-meter band on frequency of approximately 14.78 at 1400-1430; announces "La Voz de la Falange," Madrid; frequent identification (in Spanish) is given with QRA of Alcala 24, Madrid, Spain.

Horst Miers, ISW monitor in Berlin, reports a new station called *Radio Kiel* (Northern Germany) on 2.550; is chief station of German ship radio; he says another new station on 19.460, 20 kw., is located in Hamburg, used for wireless telephony from the British and American Zones of Germany to Rio de Janeiro. The Berlin Police Radio (presumably Russian) now operates on 30.4 mc., and the American Military Police Radio (Berlin) is on 37.8 mc. The Berlin short-wave transmitter (presumably in 49-m. band) was off the air when Miers sent his report.

Leslie Orton, England, reports hearing a Swedish broadcast station on 42 mc. at 1145; an American phone station in Heidelberg, Germany, on 34.5 mc.

A late report in from Beck, N. Y., confirms the belief that Oslo, Norway, is now using its 100 kw. transmitter on 15.17 for the daily 2000-2100 overseas beam; 9.610 and 11.735 in parallel are 8 kw. He reports LLK, 11.850, Fredrikstad, is heard as late as 1800 in Home Service, with 15.17 in parallel.

The new Nanking outlet on 15.250, relaying XGOA to 0915 closedown, is announcing XGRY; while announces 15.250, appears actually lower, around 15.245, as on West Coast has no interference from KRHO (15.25), but rather QRM's that station; XGOA now usually runs to 0920 and after Chinese Anthem, XGRY gives its own announcement. Sign-on is not certain but has been heard as early as 0730 (Dilg) Not audible in East yet.

# Amazing Values!



**BRAND NEW! KENYON FILAMENT TRANSFORMERS**  
For 304 TL's. Will operate two 304 TL's, etc. Sec.: 5 Volts, C.T. at 60 ..... **\$7.95**  
amps. Pri.: 115 Volts—60 cycles. Shpg. wt. 26 lbs. Never before at .....

**PERFECT FOR HOME SPOT WELDERS. NEW! AMERTRAN**  
Sec.: 5 Volts—190 amps. Pri.: 105 to 125 Volts—6 taps. .... **\$13.95**  
Shipping weight 100 lbs. Your cost.....



LIKE NEW

## GENERAL RADIO VARIACS (VARIABLE TRANSFORMER)

Model G R-200-716. Output: 0 to 135 Volts at 5 amps. Input: 115 Volts at 60 cyc. **\$ 12.95**  
Shipping weight 10 lbs. Bargain priced at.....



## HEINMAN POWER CIRCUIT BREAKERS

Like New!

Stop blowing fuses. Protect your rig with these professional circuit breakers. Shpg. wt. 2 lbs.  
5 amp.—115 volt. .... Special, net. .... **\$1.39**  
20 amp.—115 volt. ....



## RL-42-B ANTENNA REEL. BRAND NEW! MOTOR and GEAR BOX. THE PERFECT BEAM ROTATOR

This unit is extremely light in weight (4 lbs.) and is easily mounted. Has a magnetic clutch for precision stopping and will reverse with a simple s. p. d. t. switch. Or you can make your own electric-driven barbecue spit or door opener. Hundreds of other uses. .... **\$4.25**  
Shipping weight 5 lbs. Govt. cost over 20 times. Your special price.....



## TERMINAL STRIPS

Westinghouse

12 connection, molded black Phenolic. Brass screws and terminals. With holes for easy mounting. 1 3/8 x 1 7/8 x 9 in. Shipping weight 1 lb. What a Value, each **99c.**

Westinghouse  
**2 1/2" 0 to 150 Volt—60 cy.**  
**A. C. VOLTMETER**  
Nearly New! Panel mounting.  
Shipping weight **\$2.95**  
1 lb.....

Brand New!  
**MC-419**  
**LIP MICROPHONE**  
Good Quality. Low Background  
Noise. Perfect for mobile rigs and  
noisy locations.  
Shipping weight 1 lb. .... **39c.**

## HEAVY DUTY SWITCH

Bat Handle. Single Hole Mtg.  
DPST—20 amps. at 250 Volts.  
Cutler-Hammer Std. 3/8 in. bushing.  
Like New!  
Shipping weight 1 lb. .... **99c.**

# WIRE & CABLE SPECIALS



## COPPERWELD ANTENNA WIRE

Finest wire for transmitting doublets or directional antennas. Low R.F. resistance. Maintains frequency characteristics of antenna because it is stretchless. Copperweld is layer of pure copper welded to steel core. Several times as strong as regular copper wire. No. 14 gauge. Shipping weight 14 lbs. per thousand feet. Special prices **\$6.95** per thou— **\$12.95** sand ft. 2200 ft. coil.....

Same quality copperweld, but three No. 12 wires twisted together. Shipping **\$22.95** wt. 48 lbs. per coil. Per 800 ft. coil



## MICROPHONE & SPEAKER EXTENSION CORD

Two conductor best quality cord. Each conductor color coded. Spiral twisted. Overall jacket of Neoprene. Extra flexible, won't kink. Unshielded. For Mikes, PM speakers or power supply. Shipping weight 55 lbs. per 1000 ft. **\$1.95** per 100 ft. **\$14.25** per 1000 ft.

Same as above. Three conductor. Especially recommended for mikes and electro-dynamic speakers. Shipping weight 65 lbs. per 1000 ft. **\$2.45** per 100 ft. **\$19.75** per 1000 ft.

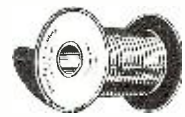

## SURPLUS SPECIALS

### STRAIN INSULATORS

Heavy Duty Glazed Porcelain. Made to Signal Corps Spec. Shpg. wt. **\$1.00** 2 lbs. per set of 8. 8 for

### LIGHTNING ARRESTERS

Famous Brach Vis-O-Glow for single, double or ribbon transmission lines. Neon Tube visibly glows in operation. Drains off static discharges and protects delicate parts of AM, FM or Tele. receivers. Shipping weight 1 lb. List Price, **\$1.95**. Special..... **75c.**

### TINNED BUS

No. 20 Soft Tinned Copper Bus. Solders easy. Ideal Hookup. Approx. 100 ft. per spool. Shipping weight 2 lbs. **\$1.00** 6 spools for.....



Shipment made by either fast truck freight, or express collect, or by parcel post if postage is included with order.

NO DEPOSIT REQUIRED ON C. O. D.'s

No orders less than \$2.50, please

# ELECTRONIC SALES CO.

5559 West Adams

LOS ANGELES 16, CALIF.

GET ON OUR MAILING LIST

# WANTED Your Name

on our mailing list to receive our  
**FREE MONTHLY BULLETIN**  
listing hundreds of outstanding  
radio bargains.  
To get your name, your address, RSE offers

## MIDGET I.F. TRANSFORMERS

Back again—by popular demand!



RSE scores again with a new and better I. F. 400-500 KC range—1 1/4" square x 3" high—ceramic based mica trimmers—high gain iron cores—pep up old receivers, ideal for new construction—and now available in either input or output types—for peak performance! Individually boxed in the colorful RSE carton. List price \$2.10. LR1—input; LR2—output;

Specify Type.

Each	Matched Pair	Dozen	Egg Crate of 100
36c	69c	\$3.95	\$29.00



## VOLUME CONTROLS

• Our own private brand—made by a nationally known manufacturer. • The same kind that net for \$1.09. • Noise-free carbon construction, standard shaft and bushing. • Individually boxed in our colorful carton carrying the RSE equality seal of approval. • Complete with switch, full range of sizes.

10 M ohms	100 M ohms	each	59c
15 M ohms	250 M ohms		
25 M ohms	500 M ohms	per 10	\$5.50
50 M ohms	1 Meg ohms	asstd.	
2 Meg ohms			
500 M Knurled Shaft			
500 M ohms less switch, 39c each, 100 for \$35.00			

## PHONO CABINET



Used in the Zenith "Cabra Tone Arm" record demonstrators. Solidly built of 3/4" plywood covered with maroon luggage cloth. 14" x 16" square, 11" high. Flocked grill for 8" speaker. Rubber mounting feet, ventilated rear cover. Brand new in factory cartons. Every record and radio shop can use these at

\$2.99

## PHONO AMPLIFIER

A high quality AC-DC phono amplifier featuring the latest circuits and tubes. The chassis is only 2" x 2 1/4" x 5 1/2" and includes volume and tone controls, built-in output transformer, and 5' rubber line cord. Complete with 35W4 and 50B5 tubes. Operates on 110 to 120 volts AC or DC. Supply is limited—first come first served

\$4.19



## OZ4'S at 73% OFF!

Until sold out—RSE offers 15000 new guaranteed OZ4 tubes. You know who made them—You can't go wrong at

59c



## ORDER INSTRUCTIONS

Minimum order—\$2.00. 25% deposit with order required for all C.O.D. shipments. Be sure to include sufficient postage—excess will be refunded. Orders received without postage will be shipped express collect. All prices F.O.B. Detroit.

DEMAND THIS  
SEAL OF QUALITY

**RADIO SUPPLY & ENGINEERING CO., Inc.**  
129 SELDON AVE. DETROIT 1, MICH.

WLKS, 6.105, Kure, Japan, BFOS, more recently has been signing off 0730; was heard later during relay of cricket matches from England some weeks ago. (Dilig, Calif.)

Those who read code will be interested in this report from Vilella, ISW monitor in Sao Paulo, Brazil, of a station in the 13-mc. band with call of ZRS, heard at 0815 on occasion, located on Marion Island, main island of the Prince Edward Group in the Indian Ocean, about 1500 miles southeast of Cape Town, South Africa, and about 1750 miles from Heard Island, where Australia Antarctic Expedition has a base with radio facilities. Has sub-Antarctic climate. Is heard rather regularly around 0800, working VJH2, Heard Island, of the Expedition; VJH2 is listed 12.255 but Vilella cannot locate it there. Says ZRS suffers bad QRM at times from a Brazilian weather station; frequency is roughly 13.370. It is presumed ZRS is at the South African air base recently established on Marion Island. He also reports CCW1, approximately 16.665, Chilean Antarctic Base of O'Higgins, contacts RAC7, approximately 15.750, Santiago, Chile, on phone at 1600, although sometimes poor reception conditions preclude use of phone and they turn to c.w.; says Chileans are now using a "special ciphering system for Antarctica."

Balbi, Calif., informs that KZFM,

Manila, is again using 9.62 in parallel with 11.84, closes down 1000.

An airmail letter from Dorothy Sanderson, Australia, lists XGOA, 9.730, Nanking, 0645 with Western music and Chinese news; XPTA, 11.65, Canton, 0545 with Western music and Chinese news; ZBW3, 9.525, Hong Kong, 0600 with relay of BBC news from London, then music; XHSR, 5.880, a Communist-controlled Chinese outlet, 0700 with Chinese news and music; XKPB, 12.120, no location given, 0515 with Chinese news (slow speed) and Western music; XMPA, 12.22, Nanking, Chinese Army Radio, 0430 with Chinese news and Western music; XMTA, 12.217, announcing call-sign, followed by Chinese news and Western music (is this same station as XMPA?); XGOY, 15.17, Chungking, 0415 with weather reports and music, news; BFES, 15.30, Singapore, 0400 with news and music; 11.77 with same at 0445; Radio Cambodia, 6.035, Fr. Indo-China, 0630 with news in French and music; YDC, 11.77, Java, 0430 with musical program and news in Dutch; YCN3, 8.090, 0510 with Dutch news and musical program; YHN, 10.841, 0500 with news, program summary, music; PLU, 9.86, 0600 with news in Dutch and music, bad QRM; "mystery" station on 9.53, 0115 with news in Polish and musical program, believed Warsaw (although Radio Polskie disclaims this one!).

—30—

One of the nation's largest sound systems was installed in the Philadelphia Convention Hall for the national political conventions and will be retained as permanent equipment in the Hall. The new system employs a versatile custom-built "gondola" supporting a cluster of 20 loudspeakers which is suspended by cables from a special remotely controlled dolly which rides along an overhead rail system. The rails extend along the ceiling for 100 feet from the front of the auditorium. The "gondola" can be lowered or raised to any desired height or moved to any location along the track to provide maximum distribution of sound throughout the auditorium. A special custom-built microphone control and mixing console is located in the center of the first balcony overlooking the arena. The console has provision for 12 microphone inputs, with controls to regulate and blend the output of the loudspeakers. Powered by approximately 1 kw., the amplifier system provides sound not only to the main arena but also to the Exhibition Hall on the floor below the arena, the Commercial Museum, the Conventional Hall restaurant, the banquet hall, and speakers outside of the building. RCA designed the equipment which was installed by Raymond Rosen Company, RCA distributors in the Philadelphia area.

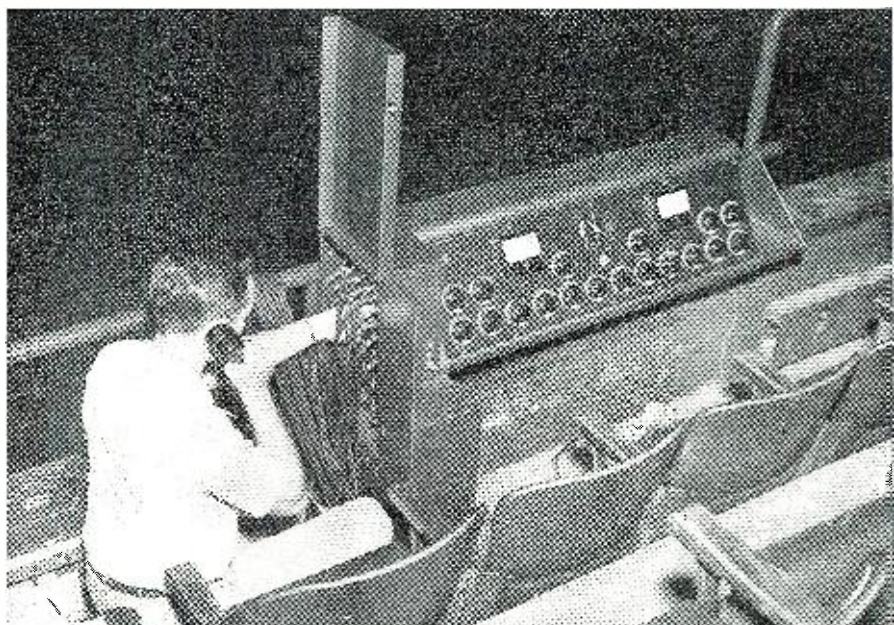

## SEPTEMBER SPECIALS

ARB RECEIVER 195-9050KC, 28VDC, tubes, remote control, tuning head, manual, less cables and plugs. New.....\$49.50

IDEAL MOBILE POWER SUPPLY  
PE237 heavy duty vibrator power supply, 6, 12, or 24v input. 525v, 95 ma; 105v, 42 ma; 6.5v, 2 amp; 6v, 500 ma; 1.3v, 450 ma; small supply 100v, 17 ma; 1.35-450 ma with spare vibrators, tubes, shock mounted—brand new.....\$29.50

7 FT. CORD CD 1086 for PE237, GN58.....\$1.95

BC-1306 SMALL COMPACT TRANSMITTER  
3800-6500 kc, 3A4, 2E22, less cover. Can be used with PE237, GN58. New.....\$9.95

K-7 GUN MOUNT ASSEMBLY, ideal mount for beam antenna, cable control. New.....\$6.95  
50 Ft. RG34U with connector. NEW.....\$3.95  
250 Ft. PHOSPHOR BRONZE stranded transmitting antenna wire. NEW.....\$3.95  
100 Ft. STEEL MEASURING TAPE. NEW.....\$5.95  
65 Ft. GUY ROPE, pulley ring and snap.....\$0.65  
182A 5 in. Selsyn compass indicators. N-I.....\$2.95

BRUSH DISPLACEMENT  
Pickup DP-1, NEW.....\$20.00

WESTON MODEL 45 AMMETER, 0-15-150 d.c. amps. NEW.....\$59.00  
DYNAMIC HEADSET and mike. NEW.....\$1.95  
Plugs for SCR-522 N-I. Per set.....\$4.00

APS-15, 3 cm. Radar Trans. with tubes.....\$14.95

Interphone Amplifier BC-709B. Ideal for Aircraft, booster for telephones, etc., N-I.....\$4.50  
BC1206A-DETROLA. NEW.....\$4.95

BC464 TARGET RECEIVER, 5 channel remote control, battery case and ant. 68-73 MC-NI.....\$14.95

BC357J BEACON Receiver, 75 mc, tubes N-I.....\$3.45  
G.E. BATTERY CHARGER: Tungal 6RB6B17, 12 battery, 12 amp; 24 battery, 6 amp. N-I.....\$67.50  
MN26 RADIO COMPASS RECEIVER, tubes 150-1500 KC, U-1, \$18.95; U-2.....\$14.95  
SIGNAL BOX KITE, N-I.....\$2.00  
HAND PUMP CPR-10198-B with 30 lb. Shallcross Gauge, Tank for silica gel, 2 bottles of gel, air hose, shut-off valve. Used for drying coax lines, instruments, etc. New.....\$14.95

EE-8 TELEPHONE FIELD SETS with handset and ringer, N-I, \$15.00 ea., \$28.00 pr.; U-2, \$10.00 ea., \$18.00 pr.; U-3, \$7.00 ea., \$13.00 pr.

### TUBE SPECIALS

5BPI .....	\$1.15	726 .....	\$4.95	6L6G .....	\$1.10
3AP1 .....	2.25	75TL .....	2.50	12A6 .....	.29
2X2 .....	.75	5BP4 .....	2.50	4 for .....	1.00
9002 .....	.75	717-A .....	.69	VR150 .....	.90

GIBSON GIRL SCR 678B transmitter for sending distress signals from boats. Trans., complete with balloons, hydrogen gens., kite and instal. manuals. N-I Export packed.....\$25.00  
Transmitter only, tubes.....\$6.95

EXTENSION CORDS, PL55 plug incl. N-I.....\$0.49  
HS-30 Ear Plug head set N-I, \$0.95; U-1.....\$0.50  
MATCHING TRANSFORMER, HS-30.....\$0.50

APN-1 ALTIMETER INDICATOR—Basic movement 0-1 ma, 5 ma shunt, 270° scale. An excellent basic G.E. movement for constructing your own meters. N-I.....\$1.95  
METER RECTIFIER, full wave midjet Selenium, 10 volts, 30 ma. N-I.....\$0.29

PL-55 PLUG, N-I, \$0.29; 4 for.....\$1.00  
AN-160 ANTENNA, N-I, 2,000-6,000 kc; 9 insulators and jumpers, 100 ft. long.....\$1.00  
BC733D GLIDEPATH RECEIVER, NEW.....\$14.95  
T-17 MIKE, NEW \$1.50; Used.....\$0.75  
SCR-274 Remote tuning head, 3 crank.....\$1.50

PE-103A DYNAMOTOR. N-I.....\$12.95  
CD-501A CABLE for PE-103A-BC654A.....\$1.95  
FRAME MOUNTING BC654A-103A.....\$4.95

TH-OAT MIKE, \$0.50; HAND KEY, N-I.....\$0.50

BC-348 MOUNTING BASE Postpaid.....\$2.50  
BC-348 OUTLET PLUG, Postpaid.....\$0.80  
BC-348 MNTG. BASE and Outlet Plug, Postpaid.....\$3.00

### \$1.00 TUBE SPECIALS

872A—1614—304TL—211; Minimum order: four tubes. NEW & CLEAN.

25 Mfd.—20,000v G.E. Pyranol Cap. N-I.....\$9.95  
12 In. CERAMIC Insulator, 1 In. Diam. N-I.....\$0.25  
12 In. CERAMIC Spacer. N-I.....\$0.20

## PHOTOCON SALES

1062 North Allen Avenue Pasadena 7, Calif.

ALLEN BRADLEY B-400 4 pole relay, 10 amps., 600 V.A.C., contacts, 110v-60 cycle coil. N-I.....\$4.95  
T-32 DESK MIKE, N-I, \$3.50; U-1.....\$1.95  
3 FT. DIAM. SIGNAL BALLOON, N-I.....\$1.50  
AN73, 7' ANT. TELESCOPES to 12". N-I.....\$2.50  
U-1.....\$1.50  
AUDIO CHOKE—I Henry 800 ma, 15,000v Test. U-1.....\$12.50  
SOUND POWERED CHEST SET, N-I.....\$5.95

GSAP 16 MM CAMERA, f3.5 lens, converted with viewfinder, battery case. NEW.....\$67.50  
USED.....\$75.00

CRANK FOR 274N RECEIVERS.....\$0.60

PHOTOFLASH CAPACITOR, 25 mfd., 2000v, N-I.....\$10.00  
6 COND. PLASTIC CABLE for PhotoFlash, N-I. Per foot.....\$0.35

RG8U CONNECTORS  
CHASSIS, CABLE, CABLE ELBOW, COUPLERS.....\$0.60 each; 10/\$4.50; 100/\$34.00

ANTENNA KNIFE switch, S.P.D.T. ....\$1.00  
PEERLESS A-4233Q line matching transformer—50/125/200/500 ohms, NEW.....\$1.50

SURPLUS RADIO CONVERSION MANUAL  
115 pages of circuits and data on BC221, 342, 312, 348, 412, 645, 946, 1068, SCR274, 522, TBY, PE-103, Surplus Index & VT Charts. Postpaid.....\$2.50

HS-23 8000 Ohm Headset, Used.....\$0.89  
OVERLOAD RELAY—Potter-Brumfield, 10 ma, 5,000 ohm D.C. trip; 115v A.C. 60 cy. reset—NEW. \$3.95  
TRANSFORMER, CASED: 200-0-200 at 50 ma, 6.3 @ 3 amps., 115v A.C. 60 cycles. NEW.....\$2.50

RM-13 REMOTE CONTROL UNIT contains E8B, handset, 1 stage amplifier, Weston DB meter, Used, 115v A.C. ....\$15.00  
Preamplifier FROM BC610, modulation limiter, etc., tubes, DB meter, USED.....\$39.00  
Less Meter.....\$34.00

CODE: N-I—NEW; USED LIKE NEW; U-1—USED EXCELLENT COND.; U-2—USED GOOD.

TERMS: F.O.B. Pasadena, unless postpaid. No C.O.D.'s under \$5.00. 25% deposit on ALL orders. All C.O.D. shipped by Rail Express. Send full price with order and we will ship by fast truck, transportation collect. Minimum order \$2.00. Californians include 2½% sales tax.

## THE NEW Rauland MODEL 151 OMNI- DIRECTIONAL FM ANTENNA

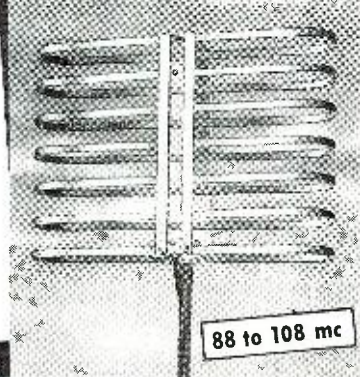

88 to 108 mc

- No Special Orientation Required
- Low Standing Wave Ratio
- High Sensitivity & Signal Strength
- All-Aluminum Construction

Has virtually circular horizontal directivity at 88 mc; only slight elongation appears at 108 mc. Affords maximum noise-reducing benefits.

### For Brilliant FM Reception

The first and only FM receiving antenna with all these features: 1. Non-Directional Pickup over the entire FM band—for satisfactory reception from all stations in any location regardless of direction of signal. 2. Higher gain for improved reception at outlying sections of the effective station area. 3. Stable Omni-directional characteristics—unaffected by rain, sleet or age. 4. Can be permanently grounded for protection against lightning. 5. Direct match to standard 300 ohm receivers. 6. Complete with 5-foot mounting mast, adjustable base and hardware. (Also available less mounting mast and base, as Model 150—ideal for use in pairs for increased signal strength and lower noise.)

AVAILABLE AT YOUR DEALER NOW!

Electronics is our business

SOUND  
TELEVISION

Rauland

INTER-  
COMMUNICATION

THE RAULAND CORP. • 4267 N. KNOX AVE. • CHICAGO 41, ILL.

## NOW COLLINS introduces... THE "Super 20" TUBE FM RECEIVER

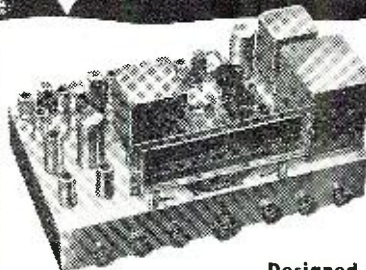

Unexcelled in  
PERFORMANCE

Remarkably  
LOW IN COST

Designed to satisfy the most critical professional or amateur, the Collins "Super 20" offers unsurpassed value in an FM RECEIVER. The advanced 20-Tube circuit features: Armstrong FM, built-in stabilized power supply and audio amplifier capable of 10-watt output; new 6AL7GT tuning eye, connections for 2 types of phono pick-up, output impedances to match 4 to 20 ohm voice coils and 500 ohm line, and variable bass and treble tone controls with attenuation and boost for upper and lower registers.

Write Today for Complete Details

COLLINS Audio Products Co., Inc.  
P. O. BOX 368 • WESTFIELD, N. J. • WE-2-4390

**SENSATIONAL VALUE!!**

**12 V.D.C.**

**MOBILE P.A. SYSTEM**

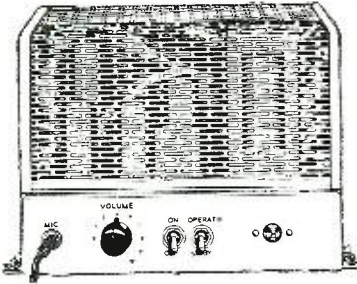

- 25 watts peak power output amplifier.
- Powered by 12 volt storage battery, drain 6 amps. "operate" and only 2 amps. in "standby."
- Mfd. by RCA, supplied with RCA close-talking Dynamic microphone, miscellaneous accessories and instruction booklet.
- Output Impedance—15 ohms (2—8 ohm speakers).

Ideal for sound trucks, portable amplifier requirements, boat or ship installations, etc. Beautifully constructed, shock mounted, and compact. Dim: 11 1/4" x 8" x 6 3/4". Uses a 6J7 driving a 6SN7 (GT) driving 2-6L6 beam power tubes. Self-rectifying 12 volt Vibrapack within amplifier. Equipment is New, surplus, and guaranteed.

**PRICE, with misc. accessories and DYNAMIC MICROPHONE \$54.75**

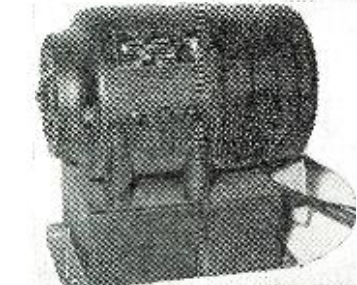

**32 VDC 110 AC CONVERTER**

Mfd. by Kato Engineering, for marine or farm installation. Rotary type, compact and ruggedly built for continuous duty. Rubber shock mounting on filter case, with complete input and output filtering. Output 110 volts, 60 cycles AC, .225 KVA, but will operate efficiently on loads up to 300 watts. New units only.

**PRICE, EACH.....\$39.95**  
**Quantities, 10 or more, Each.....\$34.95**



**5-Meter Walkie-Talkie**

Model BC-322 Transceiver; simple, popular communications unit. Freq. range 52-65 mc. Uses only two tubes, types 33 and 30. Includes a 5 mc. crystal in a crystal calibrator circuit. Range 5 to 50 miles, depending upon location and altitude. Operates from single battery block (not supplied) available from mfr., or other sources. Supplied with handset, less antenna, battery. Excellent condition.

**PRICE, EACH \$20.95**

All Prices F.O.B. N.Y.C.

All Material Offered Subject to Prior Sale

**TELEMARINE COMMUNICATIONS COMPANY**

Phone—LOnagacre 4-4490-1

280 Ninth Ave., New York 1, N. Y.

**Mac's Service Shop**

(Continued from page 66)

"When you are looking for noise, always have an unmodulated r.f. signal going through the receiver," Mac suggested. "It is surprising how often you will find a noise that will not be heard unless the set is passing a signal."

A dial lamp that showed considerable blackening of the glass bulb was replaced; the volume control was carefully checked for noisy operation; and the tubes were checked for emission. One that tested in the "doubtful" area was discarded.

"Now we will step up the line voltage to 125 volts and let the set operate on that for about fifteen minutes. That voltage is higher than will usually be encountered, and it does put some strain on various parts in the set; but any part that will not stand that kind of temporary overload is no good, anyway. Quite often this will pop a bypass that is right on the verge of shorting, or it will cause a weak filament to open up."

"Do you raise the voltage gradually to 125 volts?" Barney asked.

"No, I set it to that voltage and then turn the set on. Bypasses are usually blown during the warm-up period, especially in sets using a filament-type rectifier and cathode-type output tubes. In these sets, the load represented by the output tubes is not present to hold the voltage down for several seconds after the rectifier is delivering full output, and it is this surge that blows the condensers."

"If the set passes this test, what do you do next?"

"We lower the voltage to 100 volts and see how it performs. Some loss of volume and pep is to be expected, but the receiver should still function over the whole dial, and usable volume should be had. It is not unusual to find line voltages that drop to 100 volts during some portions of the day, especially since the wire-shortage kept many utility companies from expanding their distribution systems during the war and since such an increased load is being put on by new electrical appliances."

"Is there anything else to do?" Barney wanted to know.

"Yes, we still have to align the set. This should be done carefully, and then the chassis should be placed back in the cabinet and the set should be set up over there on the secondary bench and allowed to run for a minimum of three hours. While it is playing at low volume, a close observation should be kept on it for abrupt changes in volume, for distortion, for oscillator drift, for any unusual noises, etc."

"And if none of these things do show up?"

"Then you can feel reasonably sure that you have done all you can to pre-

**AMSCO SERVICE KIT**

- Kit includes assortment of:
- 1 pr. head-phones or lip mike.
  - 100 Resistors, 1/2 and 1-watt.
  - 100 Condensers, paper, mica, electrolytic & can.
  - 10 Switches, Toggle, Gang & Rotary.
  - 100 ft. Spaghetti, various sizes.
  - 12 Knobs, round and bar.
  - 2 lbs. Hookup wire.
  - 20 Fuses
  - 6 Volume Controls.
  - 10 Tube Sockets.
  - 1 lb. Hardware
- Bought individually would cost \$60.00—Now! Yours for only... **\$9.95** complete

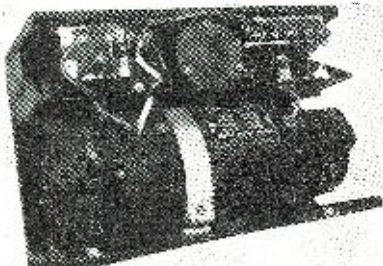

**DYNAMOTOR** For SCR-522 (SLIGHTLY USED)

- Input 24 V D.C. 12 Amp.
- 300 V D.C. .26 Amp.
- 150 V D.C. .01 Amp.
- 14.5 V D.C. 5 Amp.
- With Voltage Regulator and Filter System
- VIBRATOR—Syn. 2 Volt 7 Prong for G.E. Portables, LB-530..... 2 for \$2.49
- CAPACITOR Dry Electro. 40-40-150 Volt..... 6 for 1.79
- PARABOLIC REFLECTORS—15" spun alum. Alzak fin. for 1200 Mc up, Pr..... 3.00

**\$195**

Available 1948 CATALOG Write Today

**AMERICAN SALES CO.**

1811 W. 47th St. Chicago 9, Ill

**ECROF**

535-7 East Bay St., Jacksonville, Fla.

All items are in a good and usable condition and complete with tubes. 20% required with C.O.D. orders—please do not send postage.

BC 433G Radio Compass receiver; an excellent superhet covering 200 to 1750 kcs. Has 15 tubes wired in parallel for 6 volt operation. Simple conversion instructions to swell broadcast set and "Q-5'er". Job consists chiefly of changing 400 cycle Xfmr to any standard 60 cycle Xfmr—works beautifully with Gon-Set..... **\$23.50**

BC 929 Radar scope—makes swell RF monitor—works fb using 85 volts 60 cy. **14.50**

BC 221 with original calibration chart and Xtal..... **45.00**

ID-14/APN1 Altitude indicator—contains selsyn..... **2.50**

BC 348 complete with dynamotor..... **97.50**

ART 13 Collins Autotune Transmitter..... **175.00**

110 volt 60 cycle Generator, 2 1/2 KVA, Briggs & Stratton engine..... **165.00**

Plywood Antenna Mast sections—4" dia. 10'10" each section—5 sections normally used/per section..... **4.00**

Sleeve coupling for above—each..... **2.00**

BC 453 "Q-5'er" tunes 190 to 550 kes.... **12.50**

BC 454 tunes 3 to 6 megacycles—New \$15.00. Used..... **9.00**

BC 455 tunes 6 to 9.1 mcs—New \$16.00. Used..... **10.00**

BC 457 or BC 458..... **12.50**

BC 459 New \$25.00. Used..... **18.50**

TDE-2 Navy Transmitter—suitable for ship use..... **750.00**

Write, Wire or Phone

**EAST COAST RADIO OF FLORIDA**  
 in JACKSONVILLE

vent the customer's having trouble for a considerable space of time. You have made a check of the components usually giving trouble; you have subjected the set to mechanical jarring and electrical voltages beyond those ordinarily encountered; and you have searched with all your critical faculties for any slight signs or clues of future trouble. That is about all you can do."

"Oh yes," Mac suddenly went on, "I nearly forgot to mention that certain particular receivers have well-known weaknesses; and you *always* replace these trouble-making parts when the set is on the bench, even though they seem all right for the moment. For example, one well-known receiver has a tubular condenser in the oscillator circuit that is notorious for causing trouble. As soon as a serviceman sees one of these condensers, he automatically reaches for his diagonal cutters."

"And I used to think radio servicing was easy," Barney sighed.

-50-

## Speaker Systems

(Continued from page 53)

twenty dollars and provides excellent fidelity from both FM reception and high fidelity recorded material.

The second unit will appeal to the listener who wants a very high quality speaker system and is willing to pay a higher price to indulge his desire.

This system is built around the new Jensen type H coaxial speaker. This speaker is a new postwar design utilizing a 15 inch low frequency unit with a coaxially mounted horn type tweeter unit. It has a self-contained dividing network and includes a sharp cut-off filter with four position switch which allows the speaker response to be limited to 4000 c.p.s., 6000 c.p.s., 10,000 c.p.s., and 15,000 c.p.s. which makes the unit suitable for use with phonograph records, AM radio, and transcribed reproductions in addition to its use as an excellent frequency modulation receiver speaker.

In the interest of lower cost, the JHP-52 or the JHP-60 coaxial speaker could be used.

The enclosure for the 15 inch unit must be more rugged than that used with the smaller speaker. It is constructed of 3/4 inch plywood which is firmly braced internally. This is important, as a poorly built baffle will not only rattle, but will also introduce resonant peaks in the 50 to 200 cycle-per-second region which would spoil the otherwise excellent low frequency response of this unit.

Fig. 4 is a photograph of the completed unit, and Fig. 2B gives dimensions of the various parts. This enclosure was finished in natural wood.

Another excellent finishing means is to cover the enclosure with artificial leather. This durable material may be purchased at most upholstery shops and provides an excellent way to conceal poor grades of wood and

# SELENIUM RECTIFIERS

## And Specialized Electronic Components

### FULL WAVE BRIDGE TYPES

Input 0-18VAC		Output 0-13*VDC	
Type #	Current	Price	
B1-250	250 MA.	\$ .98	
B1-500	500 MA.	1.95	
' 1-1	1 AMP.	2.49	
B1-1X5	1.5 AMP.	2.95	
B1-3	3 AMP.	3.49	
B1-5	5 AMP.	5.95	
B1-7X5	7.5 AMP.	7.95	
B1-10	10 AMP.	9.95	
B1-15	15 AMP.	13.95	
B1-20	20 AMP.	15.95	
B1-25	25 AMP.	20.95	
B1-30	30 AMP.	24.95	
B1-40	40 AMP.	27.95	
B1-50	50 AMP.	32.95	
B1-60	60 AMP.	36.95	

### Three Phase Bridge Types

Input 0-126VAC		Output 0-130*VDC	
Type #	Current	Price	
3B7-1	4 AMP.	\$32.95	
3B7-6	6 AMP.	48.90	
3B7-11	11 AMP.	65.00	

Input 0-234VAC		Output 0-250*VDC	
Type #	Current	Price	
3B13-1	4 AMP.	\$50.00	
3B13-6	6 AMP.	\$1.50	
3B13-11	11 AMP.	110.00	

### FULL WAVE BRIDGE TYPES

Input 0-54VAC		Output 0-40*VDC	
Type #	Current	Price	
B3-150	150 MA.	\$1.25	
B3-250	250 MA.	1.95	
B3-600	600 MA.	3.25	

Input 0-72VAC		Output 0-54*VDC	
Type #	Current	Price	
B4-1X2	1.2 AMP.	\$7.95	
B4-3X5	3.5 AMP.	15.95	
B4-5	5 AMP.	17.95	

### FULL WAVE BRIDGE TYPES

Input 0-36VAC		Output 0-26*VDC	
Type #	Current	Price	
B2-150	150 MA.	\$ .98	
B2-220	220 MA.	1.25	
B2-300	300 MA.	1.50	
B2-450	450 MA.	2.25	
B2-600	600 MA.	2.95	
B2-1	1 AMP.	3.95	
B2-2	2 AMP.	4.95	
B2-3	3 AMP.	6.95	
B2-5	5 AMP.	9.95	
B2-6	6 AMP.	10.95	
B2-7X5	7.5 AMP.	13.95	
B2-10	10 AMP.	15.95	
B2-15	15 AMP.	24.95	
B2-20	20 AMP.	27.95	
B2-30	30 AMP.	36.95	

### CENTER TAPPED TYPES

Input 12-0-12VAC		Output 0-8*VDC	
Type #	Current	Price	
C1-10	10 AMP.	\$7.95	
C1-20	20 AMP.	12.95	
C1-30	30 AMP.	17.95	
C1-40	40 AMP.	21.95	
C1-50	50 AMP.	25.95	
C1-80	80 AMP.	34.95	
C1-120	120 AMP.	46.95	

\*SELECT PROPER CAPACITOR FROM LIST SHOWN BELOW, TO OBTAIN HIGH PER D. C. VOLTAGES THAN INDICATED

### RECTIFIER MOUNTING BRACKETS

For Types B1 thru B6, and Type C1	\$ .35 per set
For Type B13	.80 per set
For Type 3B.	1.20 per set

### RECTIFIER TRANSFORMERS

All Primaries 115VAC  
50/60 Cycles

Type #	Volts	Amps.	Price
NF10-18	10	18	\$3.95
NF15-12	15	12	3.95
TX136-2	36	2	3.95
TX136-5	36	5	4.95
TXF36-10	36	10	7.95
TXF36-15	36	15	11.95
TXF36-20	36	20	17.95

All TXF Types are Tapped to Deliver 32, 34, 36 Volts.

### RECTIFIER CHOKES

Type #	Amps.	Price
HY2	.03 Hy.	2 \$2.25
HY3	.03 Hy.	3 2.95
HY5	.02 Hy.	5 3.25
HY8X5	.02 Hy.	8.5 7.95
HY10	.02 Hy.	10 9.95
HY12	.125 Hy.	12 12.95
HY15	.015 Hy.	15 13.95

### RECTIFIER CAPACITORS

CF-13	6000 MFD	10VDC	\$2.49
CF-14	3000 MFD	12VDC	1.69
CF-15	6000 MFD	12VDC	2.95
CF-1	1000 MFD	15VDC	.58
CF-2	2000 MFD	15VDC	1.69
CF-3	1000 MFD	25VDC	1.69
CF-4	2x3500 MFD	25VDC	3.45
CF-5	1500 MFD	30VDC	2.49
CF-6	4000 MFD	30VDC	3.25
CF-7	3000 MFD	35VDC	3.25
CF-8	100 MFD	30VDC	.98
CF-16	2000 MFD	50VDC	3.25
CF-17	50 MFD	150VDC	.59
CF-9	200 MFD	150VDC	1.69
CF-10	500 MFD	200VDC	3.25
CF-11	100 MFD	350VDC	2.25
CF-12	125 MFD	350VDC	2.49

### VACUUM CAPACITORS EIMAC, JENNINGS, ETC.

Type #	Capacity	Voltage	Price
C50-15	70 MMFD.	15 KV.	\$12.50
C12-20	12 MMFD.	20 KV.	9.04
C50-20	55 MMFD.	20 KV.	13.36
C50-32	50 MMFD.	32 KV.	14.96
C55-32	55 MMFD.	32 KV.	14.96

Clips for above, silver plated, per pair \$3.00

### METERS

0-1 M.A.D.C. Weston #506 2" Rd., Bakelite case	\$2.95
0-15 M.A.D.C. Weston #506 2" Rd.	2.95
0-30 A.D.C. Weston w/shunt 2 1/2" Rd., aircraft type	2.95
0-50 A.D.C. Weston #301 3 1/2" Rd., Enclosed shunt	5.50
0-60 A.D.C. West. w/shunt, 2 1/2" Rd., aircraft type	3.25
0-120 A.D.C. West. w/shunt, 2 1/2" Rd., aircraft type	4.95
0-8 V.A.C. G.E. 3 1/2" Round	3.95
0-30 V.D.C. West., 2 1/2" Rd., aircraft type	2.95

### MOTOROLA HEATERS

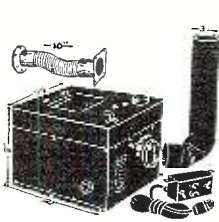

Ideal for boats, aircraft, foto-dark-rooms, trailers, cabins, trucks, etc.

The GN-3-24 Heater is of the internal combustion type using gasoline as fuel. The unit operates on 24VDC and is thermo-controlled to use minimum electrical power. Self-contained tank holds fuel for 6-7 hours of operation with heat output of 15,000 B.T.U. The blower, which supplies 125 cubic ft./min. of heated air, can be used as a cool air circulator during warmer weather. Supplied with remote control unit, flexible stainless steel exhaust, air duct elbow, and spare parts.

With instruction and maintenance manual. Specially priced **\$19.50**

### "A" ELIMINATOR KIT #KC 1-10

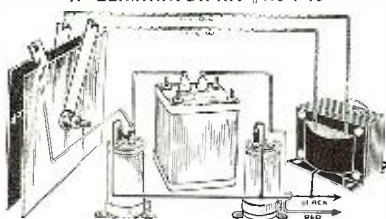

A well engineered six volt direct current power unit for Auto-Radio and similar service work, has always been in the high priced range. Now, for the first time we are presenting a fine quality unit, in kit form, embodying the essential components necessary to easily construct an "A" eliminator at a price that will meet with the approval of the most thrifty. We feel sure that this unit will fulfil a long-standing need of every serviceman and technician. This kit is designed to operate from a 115 V.A.C. 50/60 cycle source, and delivers 6 V. D.C., well filtered, at eight amperes, with a peak rating of ten amperes. Complete with pictorial diagram. Price **\$19.50**

TO AVOID SHIPPING ERRORS, KINDLY ORDER BY TYPE NO. ALL PRICES SUBJECT TO CHANGE WITHOUT NOTICE.

**ATTENTION!!!**  
INDUSTRIALS, EXPORTERS, SCHOOLS, GOVT AGENCIES, LABORATORIES  
Our engineering staff is at your service to facilitate the application of rectifiers to your specific requirements. Write for quantity discounts on company letterhead.

Minimum order \$3.00. No C.O.D.'s under \$25.00. 25% deposit on C.O.D. Add 10% for Parcel Post. Terms: Net 10 days to rated concerns only. **ORDERS PROMPTLY FILLED FROM OUR STOCKS**

# OPAD-GREEN COMPANY

71 Warren St. Phone: BEekman 3-7385 New York 7, N. Y.

# Hot Radio Values At Sun Radio



## SCR-522 VHF TRANSCEIVER

Electronically perfect and guaranteed AND COMPLETE with tubes, remote control box, dynamotor and ALL CABLE CONNECTORS but less cable. **\$24.95**



## GI Record Changer

Plays twelve 10" or ten 12" records automatically. Standard changer used in Westinghouse, General Electric, Emerson, etc. at a new, low price **\$14.95**

## P.B. Receiver **\$9.95**



Easily converted to Broadcast band with instructions furnished by us. Pushbutton-controlled, has R.F. stage and audio output stage to drive speaker. Complete with 4" speaker and schematic.



## PORTABLE Amplifying Megaphone

Complete in portable carrying case. Projects voice up to 1/4 mile. Used but guaranteed Perfect. Complete with batteries. **\$34.95**

## 100 WATT Bendix Transmitter 4 Separate ECO **\$49.95**

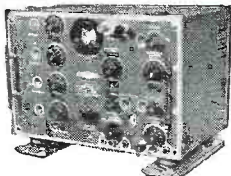

This transmitter was constructed of the highest quality of precision parts, with laboratory precision. Four separate output tanks, one 4-position selector channel switch having seven sections which changes the ECO, IPA and output tanks simultaneously. BRAND NEW, complete with tubes.

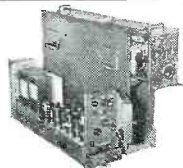

## WAVEMETER B. C.-1073A 110 Volt A. C. Power supply. Tune from 150 to 210 megacycles. **\$14.95**

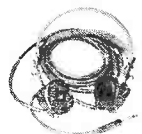

## MAGNETIC HEADPHONES 2000 ohms, 8' Cords with Army plug. All unused; show slight handling. **\$1.98**

**NOW AVAILABLE**  
200 KC  
**CRYSTALS**  
WITHOUT HOLDERS  
**69¢**  
3 FOR \$2.00

**CRYSTALS!**  
Look in past  
and future Ra-  
dio News is-  
sues for SUN'S  
spectacular  
crystal values!



**WALKIE TALKIES**  
Walkie Talkies, brand new. Complete, ready to operate with spare parts. Each..... **\$69.95**  
• TERMS: All items F.O.B., Washington, D.C. All orders \$30.00 or less, cash with order. Above \$30.00, 25 per cent with order, balance C.O.D. Foreign orders cash with orders, plus exchange rate.

**SUN RADIO**  
OF WASHINGTON, D. C.  
938 F STREET, N. W. WASH. 4. D. C.

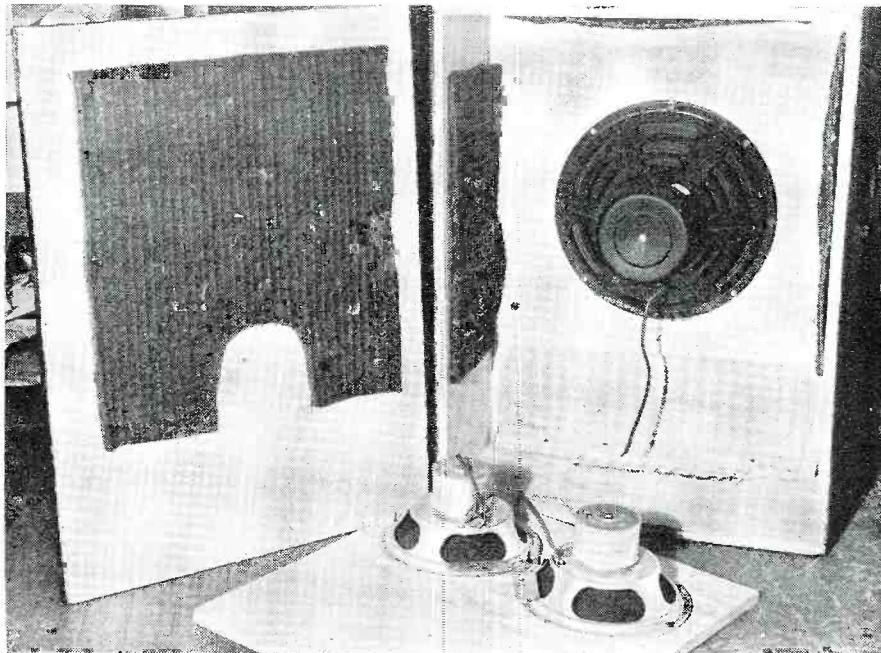

Fig. 3. Photograph shows a Jensen PM 12-CT mounted and in the foreground are two Utah 8-inch extended range speakers which may be used instead of single 12-inch unit.

the little errors in fitting which are inevitable when the builder does not have adequate tools or expensive equipment for doing cabinet work. This "leather" should be cemented down. The best cement the author has found is "Webite," a linoleum cement made by the *W. F. Webster Cement Co.*, Cambridge, Mass.

Using this means of covering the enclosure, anyone can turn out a professional looking job which is not only neat and attractive, but will be durable and easily cleaned.

The completed speaker unit should be connected to the receiver and considerable thought should be given to its placement in the room in which it

is to be operated. The best position, of course, is in the corner formed by the junction of the two walls facing the longest diagonal of the room. The worst position would be in the middle of the shortest wall. There should be no obstruction between the listener and the speaker itself, as this will eliminate the higher frequencies completely. Several positions should be tried and the most pleasing one selected.

Either of the speaker systems herein described should give results which will gladden the heart of the most discriminating listener and provide an abundance of FM listening enjoyment.

-50-

Fig. 4. Completed housing showing the 15-inch Jensen type H coaxial speaker in place.

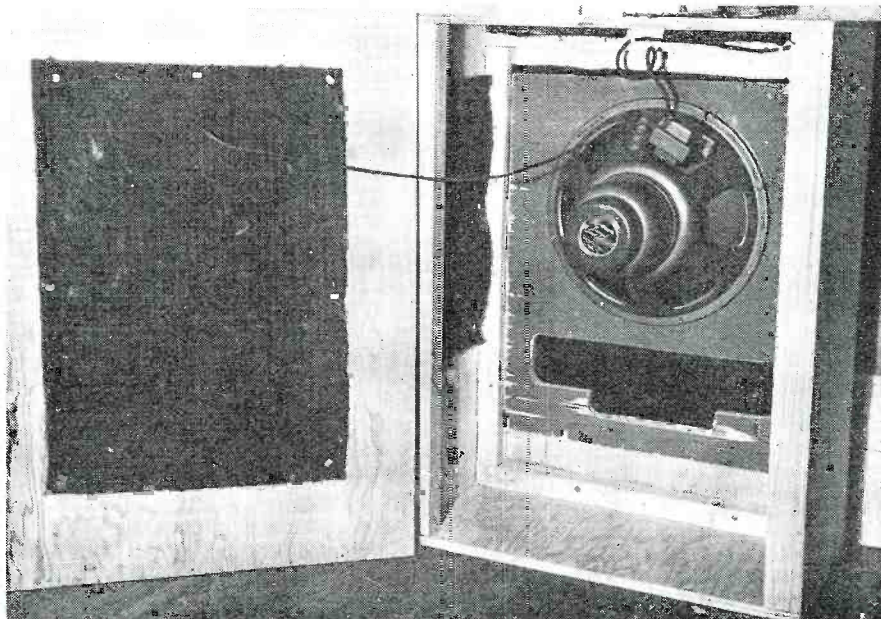



THROUGHOUT  
THE WORLD . . .



TODAY'S LISTENERS  
**DEMAND  
THE FINEST**  
The CINAXIAL Speaker

Don't limit your F.M. or Television receivers by using an ordinary speaker. Give your listeners the entire signal—with the finest speaker available.

The CINAXIAL Speaker covers the range from 50 to 15,000 c.p.s. . . . handles the output of a 10-watt wide-range amplifier . . . insures quality reproduction.

Shown above, the Model CIN 12A; list price \$27.50, for immediate delivery.

Where Quality Counts—Specify CINAUDAGRAPH

Write today for the new CINAUDAGRAPH Catalog—Dept. 149F

*Cinaudagraph Speakers*

DIVISION OF AIREON MFG. CORP.

SALES OFFICE and FACTORY 1401 FAIRFAX TRAFFICWAY, KANSAS CITY, KANSAS

**4** CONTINUOUS HOURS of PLAY  
with the MAGNETAPE  
**TWIN-TRAX  
RECORDER**  
**\$495** including microphone

NO OTHER RECORDER OFFERS THESE SPECIAL FEATURES

4 hours continuous play . . . Frequency response 40 to 10,000 cycles = 2 db . . . Individual bass and treble controls . . . Simplified tape threading . . . Heavy-duty non-overheating motor . . . No tape rewinding necessary . . . Phono pickup and turntable facilities available . . . Low hum level (DC on heaters) . . . Automatic tape reversal at end of reel . . . Sockets for VU meter and foot switch . . . Major components easily accessible . . . No mechanical noises . . . Instantaneous reverse control — without unthreading . . . Instantaneous stop — rapid start . . . High speed forward and reverse without unthreading . . . No tape spillage possible during high speed shuttle . . . Plays single track recordings made on other recorders . . . Separate recording and playback amplifiers on single chassis . . . Rubber-rimmed drive cannot develop flats . . . Complete elimination of capstan tape slippage . . . 3.2 and 500/600 ohm balanced line outputs . . . Jack for external speaker or earphone monitoring . . . Twin electronic erase heads . . . Flutter and wow ± 0.1% . . . No belts to loosen or pulleys to slip . . . Dimensions 20½" x 17" x 15½". Wt 55 lbs.

Complete symphonies and operas — or any musical or variety program up to 4 hours in duration can now be recorded and played back on a single 13½ inch reel of magnetic tape with the newly-developed Model 910-B Magnetape Twin-Trax Recorder. Incorporating new mechanical design features and the finest magnetic recording amplifier ever constructed, this exceptional instrument is the only answer to prolonged, uninterrupted high-fidelity recording of music or voice. Built-in reverse control and instantaneous stop feature makes this recorder ideal, also, for dictation and conference recording.

Tape costs are actually cut in half through the revolutionary use of two independent and isolated sound tracks on standard ¼ inch reels of tape. The cabinet, ingeniously designed for compactness and beauty, covers and protects the reels during operation of the recorder.

Its many exclusive features make this recorder unmistakably the perfect unit for the home, laboratory, industry, recording studio, and broadcast station. Also available is Model 810-B Twin-Trax Recorder, which plays for one hour at high fidelity on standard ½-hour reels of magnetic tape. Priced at \$285.00, less microphone.

If not available at your dealer, order direct



Unit operates with cover and sides closed.

**AMPLIFIER CORP. OF AMERICA**

398-2 BROADWAY, NEW YORK 13, N. Y.

**OUTSTANDING VALUES NOW AVAILABLE**

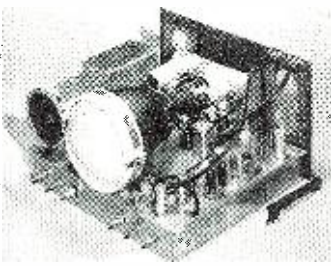

**TELEVISION KIT**

23 tube circuit—2 Selenium Rectifiers. 5 or 7 inch Cathode Ray Tube. All parts fully guaranteed. Easy-to-follow schematic with each kit.

Economical television with high quality. You can have a complete television set at this extremely low price. This easy-to-build set will give you hours of relaxation and pleasure, with a picture of unusual sharpness and sound of fine clarity and tone

Now only **\$75.00** less tubes.

Complete set of tubes, including 5BP1. **\$22.00**

Complete of tubes, including 7JP4 **\$40.00**

**PARTS SPECIALS**

**SPEAKERS**

3" PM.....	<b>95 c</b>	10" PM.....	<b>\$3.95</b>
4" PM.....	<b>\$1.29</b>	12" PM.....	<b>\$4.95</b>
5" PM.....	<b>\$1.39</b>	12" PM 46 oz.	
5" PM square		magnet.....	<b>\$7.95</b>
.....	<b>\$1.49</b>	5" 450 ohm field	<b>\$1.89</b>
6" PM.....	<b>\$1.69</b>	5" 1000 ohm	
8" PM.....	<b>\$3.59</b>	field.....	<b>\$1.89</b>

500,000 ohm volume control with switch, Long shaft, Standard Brand. **39c**, 10 for **\$3.50**.

40 mfdx40 mfd—150V condensers. **49c**, 10 for **\$4.50**

Kit of 25 wire wound enameled resistors. Assorted 10 watt—15 watt—25 watt. **\$1.95**

**SUPERIOR CONDENSERS**

This brand is rapidly gaining in popularity

8 mfd—450V.....	10 for <b>\$2.25</b>
20 mfd—150V.....	10 for <b>\$2.25</b>
10x10 mfd—450V.....	10 for <b>\$4.50</b>
20x20 mfd—150V.....	10 for <b>\$3.50</b>
50x50 mfd—150V.....	10 for <b>\$4.50</b>

**SPECIAL ON DETROLA  
RECORD CHANGERS**



**FEATURES**

- Plays 12 10-in. or 10 12-in. records
- Extremely smooth action
- 9" turntable
- Size 12" x 12" —6 ½" deep

This changer is compact enough to fit in most instal. aions.

PRICED AT ONLY..... **\$14.95**

**HIGH FIDELITY AMPLIFIER**

For finest FM and Phonograph reproduction. Complete with Pre-amp for G.E. and Pickering Pickups, 15 watts peak output.

This fine amplifier comes to you with all these features. Separate inputs for pre-amp and standard phono. Pre-amp input can also be used for mike input (through use of switch). Both inputs have separate bass and treble controls. All steel cabinet, with indirect lighted panel. Response 30-30,000 cycles ± 1 db.

SOUND AT ITS BEST

**\$49.95**

**Radio Parts Company, 614 RANDOLPH ST., CHICAGO 6, ILL.**

12" CINAUDAGRAPH P.M. SPEAKERS (HY-1112). This famous heavy duty 15 watt speaker boasts an oversize 60 oz. Amico Magnet. Factory rebuilt, like new. 6-8 ohm voice coil. FINEST REPRODUCTION for Radio, Phono or P.A. work. FULL YEAR GUARANTEE. Less transformer. Shpg. \$9.95 wt. 10 lbs. ....only

**LEOTONE**  
SEPTEMBER  
SPECIALS



RM-4 RECORDING MOTOR. Heavy duty 110V. 60 cycle shaded pole induction type. Silent operating. FOR WIRE, TAPE or DISC RECORDING. Fans, heaters, etc.  $\frac{3}{16}$ " O.D. shaft:  $3\frac{3}{4}$ " sq. x  $2\frac{1}{4}$ ". Less turntable, plate & reduction drive wheel. Shpg. wt. 6 lbs. ....\$4.95

W-110 FIELD WIRE—Made to rigid Govt. specs. Twisted stranded rubber insul. pair, outside cotton. All-purpose for indoor or outdoor Radio, Phone or P.A. work. Sold only in rolls of approx. 3000 ft. (several lengths per roll). Shpg. wt. 75 lbs. Shipped express collect. \$5.95 Per roll .....

**SPEAKER ACCESSORIES KITS**

SPEAKER CORES—Kit of 12 ass'd. 4" to 12" moulded & free-edge (magnetic in c.l.). Less voice coils. ....\$2.00  
SPEAKER REPAIR KIT—A real money & time saver. Contains: 25 ass'd. paper rings, 10 spiders, 25 voice coil forms, 3 yds. felt strips, 50 chamois leather segments, kit of 16 shims & tube of speaker cement. All for only. .... 2.49  
SPEAKER CONE RINGS—50 ass'd. cardboard mtg. rings in popular sizes. 3" to 12" ..... 1.49  
SPEAKER CEMENT & SOLVENT—3 each of all purpose cement & thinner with brush. .... .69

**Within the Industry**

(Continued from page 28)

officer in the Signal Corps, and more recently, sales work with *North Electric Manufacturing Company*, Galion, Ohio.

**GLEN McDANIEL**, vice-president and general attorney of *RCA Communications, Inc.*, has been elected a vice-president of the *Radio Corporation of America* to serve on the president's staff.



Associated with the law firm of *Sullivan and Cromwell* in New York from 1936 to 1942, Mr. McDaniel handled cases before the Securities Exchange Commission, the Federal Trade Commission, and State and Federal Courts. In March, 1942, he was named Special Counsel to James V. Forrestal, then Under Secretary of Navy. Later that year he was appointed a lieutenant in the Navy in the office of the General Counsel of the Navy Department. Promoted to Lt. Comdr. in 1944, he figured prominently in the procurement of aircraft for the Bureau of Aeronautics.

**R. I. PARKER** of Chicago has been elected a commercial vice-president of the *General Electric Company*. He succeeds W. O. Batchelder who is retiring after 43 years' service with the company.

Mr. Parker joined the *General Electric Company* as a student engineer in the Test Course at Schenectady. In April, 1913, he was transferred to the lighting engineering department and later joined the sales force of the Chicago office.

He was appointed district manager of the company's Central Station Department in 1924 and assistant district manager in 1941. He was named manager of the Apparatus Department's Central district in 1945, the post he held until the new appointment.

**JOHN F. RIDER** was recently awarded a silver plaque by the Associated Radio Servicemen of New York "in appreciation of his meritorious achievements in behalf of the radio service industry (during the years) 1921-1948." The presentation was made to Mr. Rider by Max Liebowitz, president of the recently organized service association.

**GENERAL ELECTRIC COMPANY** has announced the establishment of an advertising division in the Electronics Department of the company.

L. E. Pettit has been named manager of the new division which will operate at staff level under the manager of marketing and will be responsible for general supervision of all the

**TUBES! TUBES! TUBES!**  
BUY NOW—SAVE UP TO 80% with a 90-DAY GUARANTEE! Most tubes in stock; unsealed cartons.  
#27, 35, 36, 37, 39, 77, 84, 85, 89, 9W4, 7Z3, 6H6, 6K7, 6L7 or 6K5. ....\$0.39  
#41, 75, 76, 1NS, 6A4, 6AT, 5Y4, 1A7, 6F5, 6G5, 6J5, 6K6, 6L6, 6S8, 6SH7, 6SK7, 6RT, 7A7, 7SS, 7X4, 12SK7 or 50B5 ..... .45  
**TUBE CARTONS**—Plain White.  
Miniature (1" sq. x  $2\frac{3}{8}$ "). Per 100 ..... .98  
CT size ( $1\frac{1}{4}$ " sq. x  $3\frac{1}{4}$ "). Per 100 ..... 1.25  
Medium ( $1\frac{1}{2}$ " sq. x  $4\frac{1}{4}$ "). Per 100 ..... 1.49  
Large (2" sq. x 5"). Per 100 ..... 1.79

RG-N/C CO-AXIAL CABLE. 52 ohm, 4 ft. lths. With two PL-259 (83-15P) connectors. ....\$0.49  
9" McGUIRE CHANGER ARM (Astatic). Brown enamel finish. Less L-71 cartridge. .69  
VARIABLE CONDENSERS—4 gang, 250mmf per sec. Silvered plates close right,  $\frac{1}{2}$ " shaft. Overall:  $7\frac{1}{2}$ " x  $2\frac{3}{4}$ " x  $3\frac{1}{2}$ ". Shpg. wt. 4 lbs. .... .89  
2 gang, 365mmf, close right,  $\frac{3}{8}$ " shaft. Overall:  $2\frac{1}{2}$ " x  $2\frac{1}{4}$ " x  $1\frac{1}{2}$ ". Shpg. wt. 1 lb. .75

110V. AC RELAY (W-L). SPST. hvy duty 20A. silvered contacts. 700 ohm coil. Mtd. on  $\frac{3}{8}$ " bakelite base. Overall:  $3\frac{1}{2}$ " x  $1\frac{1}{2}$ " x  $1\frac{1}{2}$ ". Special. ....\$1.49

"O U N C E R" OUTPUT TRANSFORMER ( $\frac{7}{8}$ " x  $1\frac{1}{2}$ " x  $1\frac{1}{2}$ "). 2000 ohm tapped double primary to voice coil. Excellent with beam power type tubes. ....\$0.49



SPECIAL!!—TRANSMITTING VARIABLE. Single sect. 45-244 mmf, 37 plates. Air gap .175; rated 7000V.  $\frac{1}{4}$ " shaft. Overall:  $10\frac{1}{2}$ " x  $4\frac{1}{4}$ " x  $4\frac{1}{4}$ ". Shpg. wt. 5 lbs. FAMOUS MAKE (List \$14.50)—LEOTONE'S PRICE ONLY. \$5.95  
UNIVERSAL AUTO SUP-PRESSORS for spark plug or distributor. Elbow type. Ea., 7c; 18 for .....\$1.00

ALNICO MAGNETS—NEW EXPERIMENTAL KIT of 10 ass'd. powerful Bar, "U." Block, Circular, etc. ....\$1.98  
WRITE TODAY FOR LATEST ILLUSTRATED "ALNICO MAGNET" SUPPLEMENT.



RADIO CO., 65-67 DEY ST.  
NEW YORK 7, N. Y.

Get on our mailing list—always something new  
FACTORY SPEAKER REPAIR SERVICE

Min. Order \$2.00—20% Deposit Required on All C.O.D.'s. Please add sufficient postage

**HOBCO**  
SEPTEMBER  
SPECIALS

KEYS—J 38 Signal Corps  
Brass Nickel Plated—Silver contacts. Your cost.....each **39c**  
(3 for \$1)

AUTOMATIC RECORD CHANGER  
INTERMIX V.M. model 200-B. Plays all types 10" and 12" records. Your cost.....**\$14.95**

BRENTWOOD 14 Watt AMPLIFIER  
Complete with tubes and cover. 2 High Impedance Inputs for mike and phono. Output impedance, 4-8-16-500 ohms. Your cost.....**\$23.95**

10" P.M. SPEAKERS  
Heavy duty—Amico V Magnet. Your cost.....**\$7.95**

POWER TRANSFORMER  
110 AC Primary—6.3 V. at 4 A.—5 V. at 2 A.—620 V. Hi. Sec. Hi-Voltage C. T. Shield. Your cost.....**\$2.95**

ASSORTED CRYSTAL CARTRIDGES  
Your cost.....each **\$1.98**

Write for our Monthly Bulletins on Standard Radio Parts featuring Nationally Advertised Brands

**HENRY O. BERMAN CO., Inc.**  
Electronic Equipment and Replacement Parts  
10-12 E. LOMBARD STREET  
Dept. R-10 BALTIMORE 2, MD.

**BUILD from KITS**  
YOU CAN MAKE MODERN RADIOS AND TEST SETS YOURSELF!  
Ideal for Schools and Hobbyists

MULTITESTER  
Kit M-3c

- 1000 ohms per volt sensitivity
- Ohms and AC-DC volts
- Versatile, compact, 4x7x3" x  $3\frac{1}{2}$ " round meter. Employs following ranges: Volts AC or DC 0.5/5/50/150/500/1500; Milliamperes DC 0.5/5/50/150; Ohms 0/200/20,000/200,000. Available in bench model or portable case. Complete with simplified instructions.

VACUUM TUBE VOLTMETER  
Kit 012

- 6SN7 bridge type voltmeter circuit.
- 0-500 microamps DC.
- $4\frac{1}{2}$ " square meter.
- Output meter—600 ohm circuit. 1 milliwatt reference level.

For high frequency FM and TV. 11 megohms DC. 6.5 megohms  $\phi$  input resistance. .01 ohms to 1000 megohms in 5 ranges. Linear AC/DC volts 0-1000 volts, 5 scales. 6H6 balanced linear diode AC rectifier. 1% precision resistor. 6x3x7". Probe for high frequency. FM and TV available at extra cost. With complete instructions.

Kit S-5 Deluxe PLASTIC TABLE SUPERHET

A STREAMLINED DELIGHT

- Made-in circuit
- Built-in "Magic Loop"
- Powerful Alnico speaker

Improved superhet with built-in loop and Alnico magnet speaker! Easy tune & ir. plate dial 12SK7 IF, 12SA7 converter, 12SQ7 Det. 1st Audio, 500 power output, 12V. 32Z7 rectifier. Beautiful bakelite cabinet. Simplified instructions for assembly.

These and many other models are available at your local jobber or directly from us.

Write for catalog N  
**RADIO KITS COMPANY**  
120 Cedar Street New York 6, N. Y.

department's advertising and agency relationships. In addition the new division will have the responsibility of providing services to the department's operating divisions, such as layout and art, photography, production and printing, distribution, publicity, exhibits, and consumer inquiries.

Prior to his new appointment, Mr. Pettit was assistant to the general sales manager of the department.

\* \* \*

**COLUMBIA WIRE & SUPPLY CO.** of Chicago has recently become affiliated with the Association of Electronic Parts and Equipment Manufacturers.

The company manufactures a line of wire, cord sets, cable and other wire products for the radio, electrical, and electronic industries. Headquarters of the company are at 5734 Elston Avenue in Chicago.

\* \* \*

**WILLIAM A. BROWNE** has been named merchandising supervisor for the Radio Division of *Sylvania Electric Products Inc.*



In his new position Mr. Browne will supervise the coordination of design, production, and merchandising of test equipment for radio servicemen.

He was previously associated with *Sylvania's* Electronics Division in Boston as engineering buyer for radar development, service station manager, and customer service supervisor.

During the war he served as a lieutenant in the Navy and was active as Headquarters Squadron Electronics Office for Navy Bombers from Cape May to Brunswick, Maine.

-50-

## NO CHANGE IN CHANNEL NUMBERS

**T**HE Federal Communications Commission is not considering a renumbering of the present twelve TV channels, FCC Chairman Wayne Coy has informed the Radio Manufacturers Association.

Commenting on a resolution adopted by the RMA Board of Directors in Chicago urging that the current TV channel numbers be retained despite the deletion of Channel No. 1, Mr. Coy stated:

"Neither the report and order deleting Channel No. 1, nor the proposed rule revising the allocation of television channels changes or contemplates the changing of numbering of the remaining 12 television channels.

"Furthermore, the Commission has not received any petitions or requests to change the numbering of the remaining 12 television channels and the Commission itself has not proposed such a change.

"If the Commission were to change the numbering of the remaining television channels, adequate public notice would be provided to all interested parties, and their views and comments would be requested before the Commission would adopt any such change."

-50-

# PHOTOFACT Publications HELP YOU TO SUCCESS!

These are the indispensable service data books you'll use profitably every single working day...

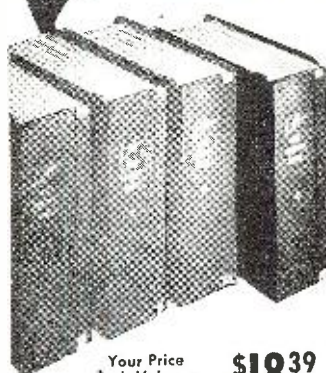

Your Price Each Volume, In DeLuxe Binder **\$18<sup>39</sup>**

## NOW! PHOTOFACT VOLUME 4 Includes First Three TV Course Installments

Bring your file of post-war receiver Service Data right up to July, 1948! Here's the most accurate and complete radio data ever compiled—preferred and used daily by thousands of Radio Service Technicians. Includes: Exclusive Standard Notation Schematics; photo views keyed to parts lists and alignment data; complete parts listings and proper replacements; alignment, stage gain, circuit voltage and resistance analysis; coil resistances; record changer service data, etc. Order Volume 4 today—keep your Photofact library up-to-date—it's the *only* Radio Service Data that meets your *actual* needs!

- Vol. 4.** Covers models from Jan. 1, 1948 to July 1, 1948
- Vol. 3.** Covers models from July 1, 1947 to Jan. 1, 1948
- Vol. 2.** Covers models from Jan. 1, 1947 to July 1, 1947
- Vol. 1.** Covers all post-war models up to Jan. 1, 1947



### 1947 Record Changer Manual

Nothing like it! Complete, accurate data on over 40 post-war models. Exclusive exploded views, photos from all angles. Gives full change cycle data, information on adjustments, service hints and kinks, complete parts lists. PLUS—for the first time—complete data on leading Wire, Ribbon, Tape and Paper Disc Recorders! 400 pages; hard cover; opens flat. Order now! **\$4<sup>95</sup>** ONLY.....



### Receiver Tube Placement Guide

Shows you exactly where to replace each tube in 5500 radio models, covering 1938 to 1947 receivers. Each tube layout is illustrated by a clear, accurate diagram. Saves time—eliminates risky hit-and-miss methods. 192 pages, completely indexed. **\$1<sup>25</sup>** ONLY.....



### Dial Cord Stringing Guide

The book that shows you the *one* right way to string a dial cord. Here, in one handy pocket-sized book, are all available dial cord diagrams covering over 2300 receivers, 1938 through 1946. Makes dial cord restringing jobs quick and simple. **\$1<sup>00</sup>** ONLY..

**THE FIRST  
TELEVISION FOLDER  
APPEARS IN  
PHOTOFACT SET NO. 46  
DON'T MISS IT!**

Now—PHOTOFACT brings you a new kind of Television Service Data—a complete, accurate analysis of a popular Television receiver—based on actual examination of the set in the Sams' laboratories. This is the beginning of a series of uniform, accurate, authoritative Television Folders, exclusively PHOTOFACT—plus the \$500 Television Course—at no extra cost to you! Don't miss Set No. 46—at your local jobber now!

**STAY AHEAD OF THE GAME —  
SUBSCRIBE REGULARLY TO  
PHOTOFACT FOLDER SETS**

HOWARD W. **SAMS** & CO., INC.  
INDIANAPOLIS 7, INDIANA

## "RANGE MASTER" MODEL 10

Measures

- (1) A.C. Current
- (2) D.C. Current
- (3) A.C. Voltage
- (4) D.C. Voltage
- (5) Resistance
- (6) Capacity
- (7) Oscilloscope Calibrator

This is the only instrument in its class that can be used as an Oscilloscope Calibrator.

## "MULTI-TESTER" MODEL 30

- A.C. Volts 0—12.5 Volts 0—125 Volts
- 0—25 Volts 0—250 Volts
- 0—1250 Volts
- D.C. Volts 0—5 Volts 0—100 Volts
- 0—10 Volts 0—500 Volts
- 0—50 Volts 0—1000 Volts
- D.C. Current 0—1 Ma. 0—100 Ma.
- Resistance 0—10,000 Ohms
- 0—100,000 Ohms
- 0—1 Megohm
- Decibels—From minus 10 to plus 57 Db.

Model 30 (Illustrated). \$15.95 net  
Model 30-K. Comp. Kit. 13.95 net

Write for Free Catalog

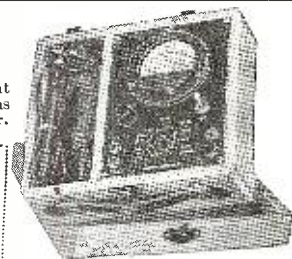

Model 10-P

- Portable Model 10-P..... \$26.95
- Portable Model 10-Fused. 28.15
- Bench Model..... 23.50
- Model 10-K. Comp. Kit.... 17.95

Prices 5% higher west of the Rockies

See your local distributor if not available, write to Dept. R. N

**BRADSHAW INSTRUMENTS CO.**

348 Livingston Street  
Brooklyn 17, New York

# HELP WANTED!

We're building up a new, larger mailing list. Won't you help by sending us your name today? You will receive confidential advance news on all our special items.

## Heavy Duty SPEAKERS

Top quality, precision-built speakers at absolute minimum cost.



3" P.M.—.68 oz Alnico V.....	\$ .99 ea.
3" P.M.—1.47 oz Alnico V.....	1.15
4" P.M.—1 oz Alnico V.....	.99
4" x 6" P.M. Speaker.....	1.89
5" P.M.—1 oz Alnico V.....	.99
5" P.M.—1.47 oz Alnico V.....	1.15

6" P.M.—2.15 oz Alnico V.....	1.55
8" P.M.—2.15 oz Alnico V.....	2.75
8" P.M.—3.8 oz Alnico V.....	3.69
10" P.M.—6.8 oz Alnico V.....	4.39
12" P.M.—3.2 oz Alnico V.....	4.95
12" P.M.—6.8 oz Alnico V.....	5.95
12" P.M.—21 oz Alnico 3 with 6V6 P.P. Output.....	\$7.95 complete
8" Dynamic 680 ohms field with 6V6 P.P. Output.....	3.95 complete
12" Dynamic 680 ohms field with 6V6 P.P. Output.....	6.95 complete
12" Dynamic 1000 ohms field.....	5.95

## Famous VOLUME CONTROLS

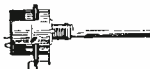

Nationally advertised brand. An exceptional buy! All brand new.

10,000 ohms V.C. with switch, 3" shaft	
25,000 ohms V.C. with switch, 3" shaft	
50,000 ohms V.C. with switch, 3" shaft	
100,000 ohms V.C. with switch, 3" shaft	
250,000 ohms V.C. with switch, 3" shaft—Tapped	
500,000 ohms V.C. with switch, 3" shaft—Tapped	
1 meg ohms V.C. with switch, 3" shaft—Tapped	
2 meg ohms V.C. with switch, 3" shaft—Tapped	

ONLY 44c Ea.

## POWER TRANSFORMERS

All fully shielded, flush mount. Quality construction at sensationally low prices.

100 mil — 6.3V @ 3 amps—5V @ 2 amps 750V C.T.....	\$2.95
150 mil — 6.3V @ 4 amps—5V @ 3 amps 750V C.T.....	3.39
200 mil — 6.3V @ 3.3 amps—5V @ 3 amps 815V C.T.....	\$4.45



## Milwaukee AUTOMATIC RECORD CHANGER

ONLY \$13.95



Complete with L-82 Astatic Crystal Cartridge Mounting Springs and Full Instructions.

## Amazing CARTRIDGE Value

Fresh stock of brand new cartridges. Order now to be sure you get all you need.

L70 Astatic Crystal Cartridge.....	\$1.49
N7 Webster Crystal Cartridge.....	1.49
Astatic Nylon Cartridge.....	2.95

MINIMUM ORDER \$1.00

WHEN ORDERING—Send 25% deposit for all C.O.D. Shipments. Include sufficient postage—excess will be refunded. Orders without postage will be shipped express collect. All prices F.O.B. New York City.

**SENCO RADIO, INC.**  
71 WEST BROADWAY  
NEW YORK 7, N. Y.  
TELEPHONE: BEEKMAN 3-6498

# RADIO QUIZ

By Ed. Bukstein  
Northwestern Vocational Institute

(Answers on page 171)

- The peak value of a 100 volt r.m.s. sine wave is (a) 155 volts (b) 70.7 volts (c) 141.4 volts (d) 110 volts.
- In a capacitive circuit (a) current leads the voltage (b) current and voltage are in phase (c) voltage leads the current (d) current lags voltage.
- The ripple frequency of a half-wave rectifier operating from the 60-cycle line is (a) 120 cycles (b) 30 cycles (c) 6.28 cycles (d) 60 cycles.
- The transconductance of a tube is the ratio of the changes of (a) plate voltage to grid voltage (b) plate current to grid voltage (c) plate voltage to plate current (d) plate voltage to grid current.
- The circuit shown in Fig. 1 is a (a) low pass filter (b) high pass filter.
- An impedance matching transformer is used to match a 100,000 ohm circuit to a 10 ohm circuit. The transformer should have a turns ratio of (a) 100 to 1 (b) 1000 to 1 (c) 10 to 1 (d) 1 to 1.
- A 5 volt, 0.3 ampere heater is to be operated from a six volt source. What value of resistor should be placed in series with the heater. (a) 83 ohms (b) 1.2 ohms (c) 1.4 ohms (d) 3.33 ohms.
- In the circuit shown in Fig. 2, the voltage developed across the resistor (a) leads the current (b) lags the current (c) is in phase with the current.
- In the circuit shown in Fig. 2, if the inductive reactance is equal to the resistance, the phase angle is (a) 30 degrees (b) 45 degrees (c) 90 degrees (d) 180 degrees.
- The sweep circuit normally used in an oscilloscope develops a (a) saw-tooth waveform (b) square wave (c) sine wave.
- The circuit shown in Fig. 3 is a (a) bandpass filter (b) band-rejection filter.
- The time constant of the circuit shown in Fig. 4 is (a) 1 second (b) 100 seconds (c) 100 microseconds (d) 10 microseconds.
- Wavelength can be calculated by (a) dividing frequency by velocity (b) multiplying frequency by velocity (c) dividing velocity by frequency.
- The purpose of the resistors and condensers shown in Fig. 5 is (a) hum reduction (b) neutralization (c) impedance matching.
- The total resistance of the network shown in Fig. 6 is (a) 5 ohms (b) 4 ohms (c) 1 ohm (d) 2 ohms.
- A square wave contains a (a) large number of even harmonics, (b) large number of odd harmonics (c) no harmonics.
- If a 0.1 volt signal is fed into an amplifier and the output is a 10 volt signal, the db. gain of the amplifier is (a) 40 (b) 20 (c) 100 (d) 10.
- If the cathode bypass condenser is removed from an amplifier stage, the result will be (a) regeneration (b) degeneration.
- When a resistor is shunted across a tank circuit as shown in Fig. 7, (a) the gain of the stage is increased (b) the "Q" of the circuit is increased (c) the bandwidth of the stage is increased.
- The cathode follower is a circuit having a (a) high voltage gain (b) low input impedance (c) low output impedance.

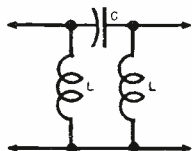

FIG. 1

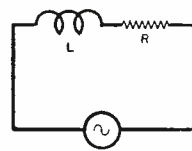

FIG. 2

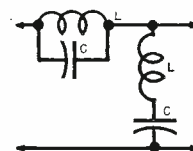

FIG. 3

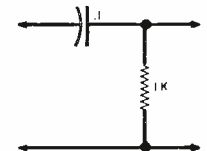

FIG. 4

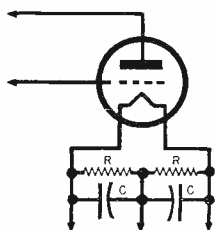

FIG. 5

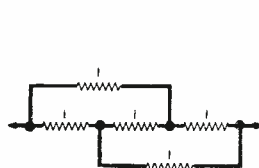

FIG. 6

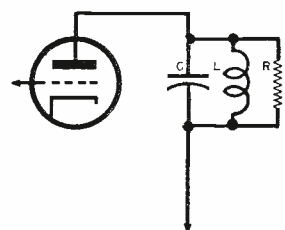

FIG. 7

# REVOLUTIONARY SOLDERING IRON

## TRANSVISION Soldetron

Tr. Mark Reg., Pat. Pend.

**For Easier, Better Soldering—on Any Job!**

- Weighs only 3 ozs., yet can do the job of a 200 watt iron.
- Heats up in 20 seconds from a cold start; saves time.
- Fingertip control; permits soldering without fatigue.



Ready for attachment and operation on 110 V A.C., 50-60 cycles, through transformer supplied with iron, or 6-8 volt A. C. or D. C. without transformer (from an automobile battery).

Overall size 9 1/4" x 1 1/2"; ship. wt. approx. 4 lbs.



- Ideal for fine precision work in "hard-to-reach" places.
- Readily interchangeable tip-heads; no cleaning or filing.
- Retains heat with switch off up to 1 minute; efficient.
- Bakelite handle, cork covering, for comfortable cool grip.

**PRICE: including transformer and Tip-Head "A", \$13.95**  
5% higher west of Mississippi; fair traded.

Ask your distributor, or for further information write to:

**TRANSVISION, INC. DEPT. RN NEW ROCHELLE, N. Y.**

In Calif.: Transvision of Cal., 8572 Santa Monica Blvd., Hollywood 46

# Boost all 13 Channels

WITH THE

## VIDEAMP\*

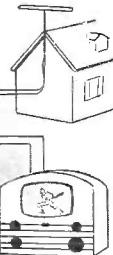

- REDUCES IMAGE INTERFERENCE FROM FM, OR OTHER CARRIERS
- PROVIDES BRIGHTER IMAGES
- HAS ANTENNA MATCH SYSTEM FOR PARALLEL LINE OR COAX
- BRINGS IMAGES IN ON AN INDOOR ANTENNA IN THE PRIMARY SERVICE AREA
- WITH OUTDOOR ANTENNA EXTENDS SERVICE AREA BEYOND LINE OF SIGHT

TRADE MARK REGISTERED

CRYSTAL DEVICES CO., INC.  
1819 BROADWAY NEW YORK 23, N. Y.

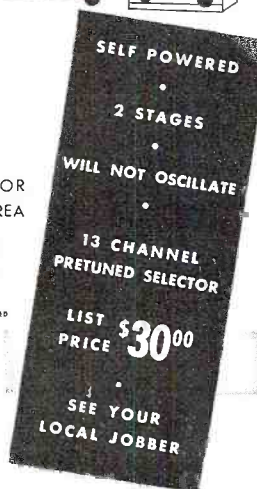

# IT'S NOT TOO LATE YET!

## LIMITED QUANTITIES OF THESE FINE SETS STILL AVAILABLE

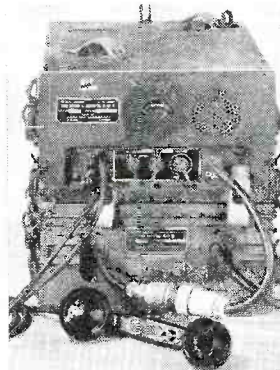

### FAMOUS PORTABLE BC-659 TRANSCEIVER

27 to 38.9 Mc. xtal controlled; ideal for "hams," police, seismograph, park service, etc. Battery operated power supply 6, 12 or 24 volt with proper vibrator. As shown, with all tubes, diagram and meter, less handset and xtals. Used, fair, less power supply, some need minor repairs. \$4.95

POWER SUPPLY PE120, used, good ..... 7.95  
BC-659 and power supply, both ..... 11.95  
Choice xtal, any channel ..... 1.00  
Set of 120 xtals in case ..... 35.00  
Battery BA-41, unused, when purchased with BC-659 ..... .50  
Extra diagrams, each ..... .50

ADAPTER M-399 for align: converts rec. ampl. stage to VTVM circ. using meter of set. NEW ..... 1.50  
HANDSET TS-13 with PL-68 and PL-55; used, excellent ..... 3.95  
BATTERY CASE f/BC-659, same as PE-120 case. Good for tool box. Like new w/cable and plug. .... 1.95

27 to 38 Mc FM RECEIVER BC-683 for police, park service, seismograph, "hams." Superhet, BFO, squelch; 10 pushbuttons and manual tuning; Can be easily extended to 40 Mc. with 10 tubes, speaker, case and diagram, 12 or 24 volt dynamotor. Used, good \$18.95

Mounting rack FT-237 for 2 receivers and 1 BC-684 xmitr. with necessary plugs ..... 5.95

Free instructions to convert to 115 VAC and 88 to 108 Mc. For mobile operation, use PE-103 dynamotor.

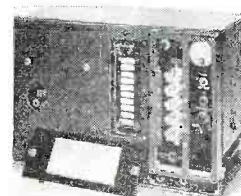
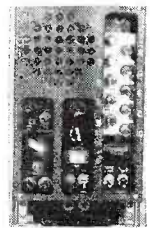

27 to 38 Mc FM TRANSMITTER BC-684 30 watt, 10 channel pushbutton controlled; with covers, all tubes, meter, diagram, less xtals, some with dynamotors. Used, good ..... \$18.95

Choice of xtal for any channel ..... 1.00  
Set of xtals in drawer. Choice of 27 to 34.9 or 31 to 38.9 Mc. .... 14.95  
COMBINATION OFFER: BC-683 and BC-684, both for ..... 35.00

20 to 28 Mc FM RECEIVER BC-603 for 11 meters; looks just like BC-683 receiver above; can be tuned to 10 meters with slight modification; superhet, BFO, squelch; 10 pushbuttons and manual tuning. Makes fine 10 meter converter or I.F. strip for 88 to 108 Mc wide-band FM; with 10 tubes, speaker, case, diagram; used, good, 12 or 24 volt ..... \$11.95

FREE CONVERSION INSTRUCTIONS for 88 to 108 Mc wide-band FM; also easy change to 115 VAC. Complete conversion (power supply and converter) costs less than \$7 to build.

20 to 28 Mc FM TRANSMITTER BC-604 for 11 meters; looks just like BC-684 xmitr. above; can be operated on 10 meters by use of proper crystal; 10 channel pushbutton xtal controlled; with all tubes, meter, diagram, case and covers; less xtals; 12 or 24 volt used, good ..... \$7.95

COMBINATION OFFER: BC-603 and BC-604, both for ..... 18.95  
Set of 80 xtals in drawer for BC-604 (when bought with BC-604) ..... 10.95  
Mounting rack FT-237 1/2 rec'rs. and 1 xmitr. with plugs ..... 5.95  
27 to 38 Mc FM TRANSMITTER BC-924; companion to BC-923; similar to BC-684; used, with all tubes; cases fair, OK inside ..... \$11.95

## BACK AGAIN!

EE-S TELEPHONE ..... \$4.95

With handset, generator, ringer, etc. in case. Fine for garage extension, farm phones, warehouses, etc. For magneto or common battery lines. EACH PHONE TESTED BEFORE SHIPMENT.

Used, fair ..... \$4.95  
Used, good ..... 9.95

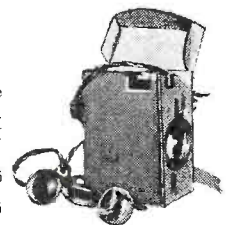

TELEGRAPH SET TG5 battery operated; includes key, carphone, buzzer, bell and sensitive relay, in case 7"x5"x4". Used, each \$3.65, two for ..... \$6.95  
SIGNAL GENERATOR, Ferris No. 18C Microvoltage; range 5 to 175 Mc in 7 bands; EXT. 400 or 1000 cycle mod. A precision instrument at 1/4 original cost; used, guaranteed ..... \$125.00

**TERMS:** Check with order or 25% deposit on C.O.D.'s

All items sold F.O.B. Oakland, Cal. until Sept. 15; after Sept. 15 F.O.B. Tulsa. FREE LIST.

# ELECTRONIC SUPPLIES

317-R East 2nd St.

Tulsa 3, Okla.

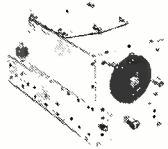

### COMMAND RECEIVERS

(With Schematics)  
 BC 454 3-6 MC NEW: \$5.95  
 BC 455 6-9.1 MC NEW: \$7.95

#### TRANSFORMER FOR RECEIVERS

115 Volt, 60 cycle Primary; Sec. 250-0-250 Volt 50 MA; 6.3 Volt and 24 Volt, with AC Schematic. **\$2.95**  
 TUNING CRANK FOR RECEIVERS.....50c

### TRANSMITTERS

(With Schematics)  
 BC 696 3-4 MC Used: \$14.95 NEW: \$18.95  
 BC 458 5.3-7 MC NEW: \$7.95  
 BC 456 MODULATOR Used: \$1.50 NEW: \$2.50



#### TRANSFORMER FOR TRANSMITTERS

Primary 110 Volt, 60 cycle. Sec. 525-0-525 Volt. 350 MA; 12-12 or 24 Volt 3 amp., 5 Volt 3 amp. **\$9.95**

**SCHEMATICS of COMMAND REC., TRANS. MODULATOR and CONTROL BOX.**  
 Complete Set.....\$1.50 Postpaid

### SPECIAL OFFER

**TUBE CONVERSION CHART—VT to Commercial—Sent at NO COST with your Order!**

#### WALKIE-TALKIE BC 222

Portable Radiotelephone, transmits and receives anywhere in the 28 to 52 MC frequency range, including 6 and 10 Meters. Complete. Checked before shipped. Used (Tested).....\$39.50 NEW.....\$49.50

### LOOP LP-21

RADIO COMPASS INDICATOR ANTENNA

Can be used for small beam rotator. Loop rotated by selsyn motor, also has selsyn indicator trans. for remote indication, and slip ring assy. Wiring diagram for AC operation is included. Used, Tested..... **\$3.95**

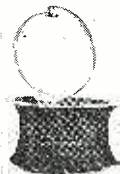

### SELSYN INDICATOR AND MOTOR

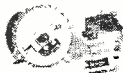

Part of L.P-21 Loop. 0-360 calibration on selsyn. Wiring Schematic included. Used (Tested)..... **\$2.95**

### I-82 5" INDICATOR

Radio compass indicator use with selsyn for remote indication. Prices: Used (Tested) **\$2.95**  
 NEW:.....\$4.95

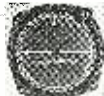

### U.H.F. COAXIAL CABLE

125 ohm, flexible Polystyrene, beaded, cotton covered. Amp. 76-30. Prices: 50 foot roll..... **\$1.25**  
 TWO 50 foot rolls.....\$2.00

#### TG-10 AUTOMATIC KEYS

Amplifier 25 Watt. This well designed keyer can be used for code classes. Photo cell is actuated by ink tape recording, can be converted easily to a 25 Watt amplifier, 110 Volt, 60 cycle operation. Comes with two 6L6's, two 6SJ7's, two 6N7's, and one 5U4G output trans. 4 S, and 15 ohm. Tape motor can be used as phono motor. Used but in good condition **\$19.95** (tested)

#### MINIMUM ORDER—\$2.00

All Prices are F.O.B., Lima, Ohio  
**25% DEPOSIT ON C.O.D. ORDERS**

### Portable Stroboscope

(Continued from page 39)

The flash-bulb socket is first removed from this reflector and its hole enlarged (by reaming) to clear the *Sylvania* 2D21 strobotron tube. The two legs of the mounting bracket (which was intended to be clipped into a photographic flashgun) then are clipped short and drilled for screws which hold the shell of the strobotron tube socket, a 4-contact *Amphenol* 78-PF4 female cable unit. The 4-wire cable, connected at one end to the strobotron socket and at the other to the female *Jones* plug, is a 5-foot length of very flexible, rubber-covered *Belden* 8454 cable. No shielding is required in or around this cable.

#### Calibration of Frequency Control

If the stroboscope is to be used as a tachometer, that is for the actual measurement of speeds (revolutions per minute) and of other rates of motion, rheostat  $R_2$  may be provided with a direct-reading dial or scale. The calibration setup is shown in Fig. 3A, and the following calibration procedure is recommended:

1. Connect variable-frequency audio oscillator to horizontal amplifier input terminals of oscilloscope.
2. Connect "high" vertical amplifier input terminal of oscilloscope to "Test Point No. 1" in stroboscope circuit (See Fig. 5).
3. Connect grounded vertical amplifier input terminal to "Test Point No. 2" in stroboscope circuit.
4. Switch-off internal sweep of oscilloscope. Set scope sync control to "Internal."
5. Set rheostat  $R_2$  to high-resistance limit.
6. Set oscillator frequency to about 50 cycles and advance oscillator output control to maximum.
7. Switch on stroboscope (with strobotron tube connected).
8. Adjust vertical and horizontal gain controls of oscilloscope for pattern size that just covers scope screen.
9. Adjust oscillator frequency dial carefully for stationary single-pulse

Fig. 7. Rear view of stroboscope case. The "On-Off" line switch is mounted through the lower portion of the rear panel. The power cord passes through grommets hole.

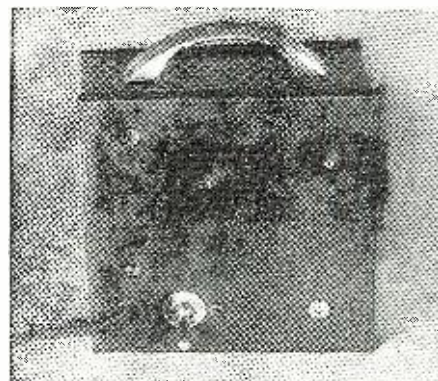

## FAIR RADIO SALES

132 SOUTH MAIN ST. LIMA, OHIO

### ORDER NOW

- 304 TL (New in Cartons), bargain... \$ .90
- 5 Volts @ 60 amps. Filament Transformers for two 304TL Kenyon—Surplus—Excellent Condition... **7.95**  
 50c for packing
- 300 ohm Amphenol.....per C **2.91**
- 150 ohm Amphenol.....per C **2.62**
- 75 ohm Amphenol (small)...per C **2.01**
- 75 ohm Amphenol (heavy duty) per C **7.20**
- Kilowatt 75 ohm Amphenol Twin Lead, per 100 ft..... **7.20**
- SCR 522 Dynamotors PE94C, New.. **3.95**
- SCR 522 Receiver Conversion Kit and Instructions (Less Dial)..... **3.50**
- ACN Dial for above..... **3.30**
- 3 Gang 410 Mmfd. Per Sect. Cond. Excellent Quality..... **2.95**
- 4 Gang—150 Mmfd. Variable..... **.95**
- 4 Mfd. @ 600V—Oil—Round Can. **.69**
- New Phone Plugs..... **.18**
- 807—New—Boxed..... **1.49**
- 2C40 Lighthouse Tube..... **.95**
- 2" PM Speaker (Bakelite Cased) Used in Walkie Talkie..... **1.95**
- SIREN, Commercial type hand operated, very loud noise, gov't cost \$21.00. Spec..... **4.95**
- TRANSMITTING CONDENSER, 2 mfd. @ 2500 W. V. each.... **2.95**
- New Relay Leach, 115 V-AC DPST. **1.50**
- 872A—Surplus, New, Boxed, 2 for Phosphor Bronze dial cable, 42 strand, 250 ft. spool..... **.69**
- 2051—Tube Thyatron..... **.39**
- New Surplus Jones 6 and 8 prong plugs **.24**
- Toggle Switches SPST plus spring return **.24**

Send for Our Special Bulletin of Government Surplus Items

### DOW RADIO

1759 E. COLORADO ST., PASADENA 4, CALIF.  
 Pasadena Phone—SYcamore 3-1196  
 Los Angeles Phone—RYon 16683

### "America's Best Buy" TUBULAR ELECTROLYTICS

Fresh Stock. Fully Guaranteed

Capacity	W.V.	Each	per 10	100
25 mfd.....	25V	\$0.17	\$1.59	\$14.95
50 mfd.....	50V	.21	1.79	16.95
100 mfd.....	50V	.24	2.29	19.98
20 mfd.....	150V	.21	1.89	17.95
30 mfd.....	150V	.22	1.95	18.95
40 mfd.....	150V	.23	2.04	19.74
50 mfd.....	150V	.24	2.14	20.45
20-20 mfd.....	150V	.29	2.49	22.98
30-20 mfd.....	150V	.32	2.95	25.98
40-20 mfd.....	150V	.36	3.25	29.95
50-30 mfd.....	150V	.39	3.49	32.98
8 mfd.....	450V	.21	1.99	19.50
8-8 mfd.....	450V	.42	3.98	35.76
16 mfd.....	450V	.39	3.74	33.78

#### BY-PASS CONDENSERS

.01.....	600V	\$0.06	\$0.55	\$ 4.60
.02.....	600V	.06	.55	4.75
.05.....	600V	.06	.55	4.95
.1.....	600V	.07	.65	4.49
.25.....	600V	.11	.98	8.95
.005.....	1700V	.14	1.25	9.95
.007.....	1700V	.14	1.25	9.95
.01.....	1700V	.15	1.30	10.20
.02.....	1700V	.16	1.40	10.95

An assortment of 50 of the above By-pass condensers. Fine value for the small shop or experimenter, only \$2.98.

#### RESISTOR ASSORTMENT

100 assorted 1/4-1/2 watt carbon resistors All RMA color coded. Special \$1.29.

#### NEW PANAM CRYSTALS

**NOT WAR SURPLUS**  
 Your frequency plus or minus KC. Fundamentals from 3500 KC. to 8500 KC. in new "PA43" holders. (Same as FT-243.)

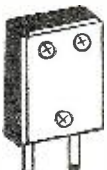

**\$169**  
 EACH

Postage extra 20% deposit on COD. Write for latest bargain list featuring "America's Best Buys."

#### POTTER RADIO CO.

1314 McGee St., Kansas City 6, Mo.

pattern such as shown in Fig. 3B. At this point, strobotron flash rate (number of flashes per second) is equal to oscillator frequency (cycles-per-second). To convert this value to flashes-per-minute, multiply by 60. Mark this rate at corresponding point on dial or scale of rheostat  $R_s$ .

10. Repeat procedure at as many points as possible up to the highest flash rate of strobotron (point of minimum-resistance setting of rheostat  $R_s$ ).

### Using the Stroboscope

Use of the stroboscope is extremely simple:

1. Plug stroboscope into nearest a.c. power line outlet and switch on.
2. Point reflector at moving machine or moving part under observation.
3. Adjust rheostat  $R_s$  until point is reached where machine (or part) seems to stand perfectly still. Observe operation of machine or part being viewed—that is, note whether part whips, runs out of line, slips, or vibrates. (A free, smooth operating part will show no such extraneous movement when it has been "frozen" by the stroboscopic light).
4. When the moving part has been frozen, read its rate or speed from stroboscope dial.

### Observations

When the flashing rate of the stroboscope equals the rate of speed of the moving part under observation, the part apparently stands still.

When the stroboscope rate is slightly less than the machine speed, the machine is seen to turn slowly to the right.

When the stroboscope rate is slightly higher than the machine speed, the machine is seen to turn slowly to the left.

When the stroboscope rate is a "harmonic" of the machine speed, multiple images will be seen. For example; if the stroboscope rate is four times the speed of a 2-blade fan, four blades will be seen standing still.

-30-



September, 1948

# IMMEDIATE DELIVERY

### MICROWAVE ANTENNA—

AS-217A/AGP 15B. 12 Cm dipole and 13 inch Paraboloid housed in weather-proof Radome 16" diam. 24 V. DC spinner motor for conic scan. Stock #SD-95. Shipping wt. 70 lbs.

**Price \$9.50 each**



### Remote Position Indicating System—

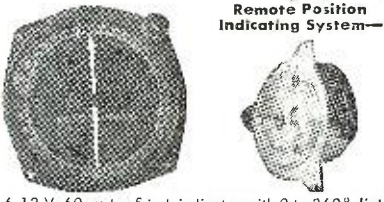

6-12 V. 60 cycles 5 inch indicator with 0 to 360° dial. Heavy duty transmitter. Stock #SD-115.

**Price \$9.95 per system**

### Null Type Synchro Indicator



Precision position indicator. Uses Bendix Size 5 Selsyn rectifier tube, transformer, magic eye tube and illuminated 360° dial. Ideal for Hams, labs and experimenters. May be used with SD-43 Synchro transmitter. Stock #SD-119.

**Price \$7.95 each**

### Size 5 Synchro Generator



Similar to Navy Ordnance type 5G with shaft detail per Army Ordnance Dwg. C-78414. 115 V. 60 cy. Stock #SD-43. **Price \$14.50 each.**

### 110 RPM MOTOR



G.E. 5BA10J18D. 27 V. @ 0.7 amps. 1 oz./ft. torque. 1 7/8" diam. x 3 1/2" lg. Operates on AC or DC. Stock #SD-98.

Include 15c for P.P. and handling  
**Price \$2.95 ea. net**

### Kollsman 775-01 Selsyn



Ideal for Ham use as transmitter or receiver. 6-12 volts 60 cycles. 26 volts 400 cycles. Stock #SD-57.

**Price \$3.75 each**

### SELSYN SPECIAL



V.E. KS-5950-12. Size 5, 115v. 400 cycles. Use on reduced 60 cycles.

Stock #SD-182. **Price \$4.75 each.**

### BEAM ROTATOR



1 rpm. 12 v. DC or 40 v 60 cy. operation. Reversible. 3 1/2" diam. 5" lg. 1/2" diam. spline shaft. Ideal for Ham or television antennas. Stock #SD-185.

**Price \$9.50 each.**

### DYNAMOTORS



D-101. 27 v. DC in @ 1.5 amps. DC output 285 v. @ 0.60 amps. Stock #SD-187.

Price \$1.50 each. DM-40A. 14 v. DC in @ 3.4 amps. DC output 172 v. @ .138 amps. Stock #SD-188. **Price \$3.25 each.**

### SWEEP GENERATOR CAPACITOR



Hi-speed bearings. Split stator. Silver plated coaxial type. 5-10 mmf.

Stock #SD-167. **Price \$2.75 each**

### TACHOMETER GENERATOR



Blinco PM-2 2 v. DC per 100 rpm. Use to 2000 rpm. Stock #SD-53. **Price \$7.50 each.**

Write for complete listing, or call ARmory 4-3366

## SERVO-TEK

Products Co. Incorporated  
Surplus Division

4 Godwin Ave. Paterson, N. J.

Open account shipments to rated concerns.  
All prices F.O.B. Paterson, N. J.

### SEPTEMBER SPECIALS

966 1FF R.F. Chas. with high freq. tubes. No dynamotors. Lots of parts. Money back if you're not satisfied .....2 for \$2.50, 4 for \$4.75  
12,000 Ohms Sensitive Relays with D1P1 cont. ea. \$1.00  
5CP1 Kinescope Tubes—For Television.....ea. \$1.95  
New 5D21 Kilowatt Tetrodes.....ea. \$4.95, 2 for \$9.00  
Marker Beacon Receiver B.C. 357. \$2.75 B.C. 1033 \$3.25

### TROUP ENGINEERING CO.

2221-A Grand Avenue Long Beach 4, Calif.

## Radio Technician and Announcers

A practical 15-month course in First Class Radiotelephone Operation and Announcing is offered by Don Martin School of Radio Arts. Most stations these days require combination men. We specialize in this type of training and maintain a placement bureau for our graduates. Serving the industry for 10 years, the School of Radio Arts can train you. Write for our catalogue outlining the courses offered. Classes can be arranged so you can do part time work on the side.

APPROVED FOR VETERANS

DON MARTIN SCHOOL OF RADIO ARTS  
1655 North Cherokee St. Hollywood 28, Calif.

## U. S. SURPLUS! NEW! SHATTERPROOF ALL PURPOSE STEEL BOTTLE

USE FOR LIQUIDS, GASES OR CHEMICALS, etc. MAY ALSO BE USED AS AN AIR PRESSURE TANK

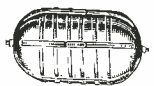

Formerly used by AAF for oxygen storage. You can use it now as an air pressure tank for inflating tires, operating horns, air motors, etc. May also be used as a buoy or float or for water supply storage on boats, trailers and trucks. Ideal as shipping container for gases, chemicals, etc. Bottle is non-shatterable with working pressure up to 500 lbs. psi. and weighs only 5 lbs. when empty. Internal volume 500 cu. in. (approx. 9 qts.). Has 3/8 in. pipe thread at each end. Approx. size 2 1/2 x 6 in. They won't last long at this low price. Stainless steel. **\$2.95** each \$3.95. Regular steel, each.....

F.O.B. Houston. Mail orders promptly filled. Send check or money order. Satisfaction guaranteed.

**AERO PARTS SUPPLY, Dept. RN9**  
Municipal Airport Houston 17, Texas

# NEW RECEIVERS for Fall Market

## STROMBERG-CARLSON VIDEO

*Stromberg-Carlson Company* unveiled its new "Rochester," Model TV-12H1 table model television receiver at the National Association of Music

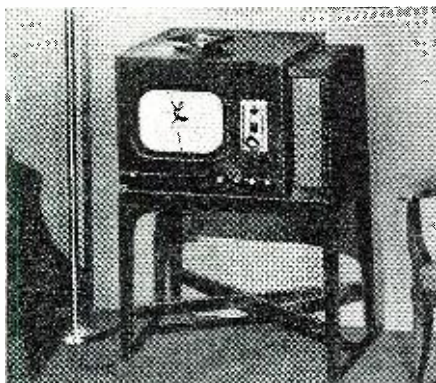

Merchants Convention held in Chicago this summer.

The new receiver features a 12 inch screen affording 72 square inches of picture content. The combination television-FM chassis is housed in a modern cabinet of mahogany veneer. The receiver covers all television channels and the full range of the 88 to 108 mc. FM band.

The 5½ inch speaker system is adequate for most telecasts but may, in the case of a symphony or similar musical program, be connected by a special adapter cord to a console radio by an audio coupler designed to take advantage of the larger unit's audio and speaker system.

*Stromberg-Carlson Company*, Rochester 3, New York, will furnish further details on the "Rochester," Model TV12H1 on request.

## AIR KING PORTABLE

*Air King Products Co., Inc.* of Brooklyn is making deliveries on the



company's new Model A-520 three-way portable.

This newest addition to the line is designed to withstand outdoor elements. It may be operated on a.c. or d.c. or on the self-contained batteries. The set is housed in a polystyrene

cabinet in either maroon trimmed with ivory or ivory trimmed with maroon.

The Model A-520 weighs 4½ pounds with batteries and measures 8¾ by 4¾ by 4 inches. The set retails in the moderate price class.

For full information, write to *Air King Products Co., Inc.*, 170 53rd St., Brooklyn 32, New York.

## LOW-COST VIDEO

*Pilot Radio Corporation* has announced a new television receiver which will retail under one hundred dollars.

Known as the "Candid T-V" unit, this set weighs less than 15 pounds and measures 14 by 9½ by 13½ inches. The set is said to be completely portable and is available with an alligator leatherette carrying case at additional charge.

According to the company, the receiver can be operated in most locations with only the simple inside doublet wire furnished with the unit. A 3 inch direct view picture tube is housed

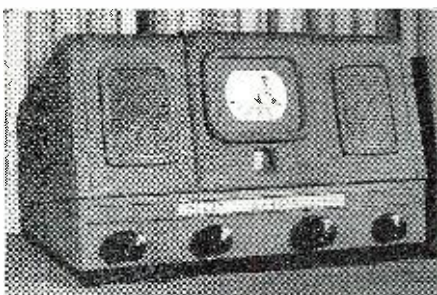

in the wrinkle finished aluminum cabinet. The set uses 21 tubes, including the picture tube and 3 rectifiers, and offers full 13 channel coverage. There are four principal controls for tuning, brilliance, contrast, and volume. The set operates only on a.c.

Further information on the "Candid T-V" may be secured from *Pilot Radio Corporation*, 37-06 36th Street, Long Island City 1, New York.

## "POP-OPEN" PORTABLE

*Zenith Radio Corporation* has added a new portable receiver that pops open and starts playing at the touch of a button, to its line of home radios.

Called the "Universal Pop-Open," this receiver functions at the operation of the button on the top of the case. This button causes the "Dialspeaker" doors to open and the "Wavemagnet" to rise above the set where it can give maximum performance. The unit operates on either a.c. or d.c. or a self-contained battery pack.

The set is housed in a cabinet with

two-tone grey beige finish and features a "Flexo-Grip" handle for easy carrying. The handle folds down flat against the top when not in use. The portable weighs 15¼ pounds with batteries.

The "Dialspeaker" feature, a development which combines a large dial and speaker in the same space, permits the use of a 5¼ inch speaker in this set.

*Zenith Radio Corporation*, 6001 West Dickens Avenue, Chicago 39, Illinois, will supply full details on the "Universal Pop-Up" to those requesting this information from the company.

## TABLE MODEL TV

*Remington Radio Corporation* of White Plains, New York, is now in

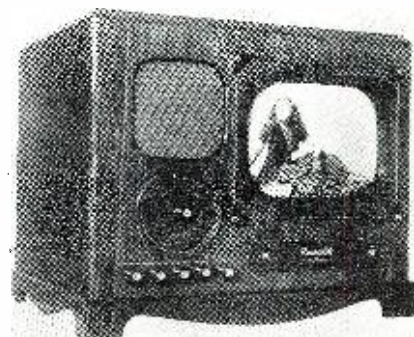

production on the "Rembrandt" Model 1950 table television receiver.

The new receiver uses a 12 inch *Du-Mont* cathode tube producing an image 78 square inches in size. The unit also incorporates FM radio reception. The set has a.f.c., a clipper circuit which is designed to eliminate line interference, an 8 inch FM speaker, and is housed in a hand-rubbed cabinet in either mahogany, blonde mahogany, knotty pine, oak, maple, or Chinese pastels.

Further information on the "Rembrandt" 1950 may be secured from *Remington Radio Corporation*, 80 Main Street, White Plains, New York.

## G.E. PORTABLE

*General Electric's* new Model 150 is a lightweight plastic portable weigh-

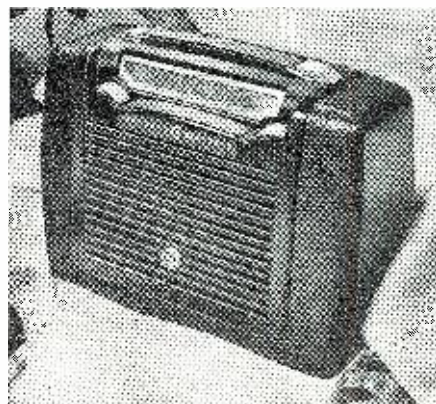

ing only 11 pounds, complete with battery pack.

Capable of operating on a.c., d.c., or batteries, this receiver is available in



# FOR FINER CUSTOM INSTALLATIONS

## No-Drift FM-AM Tuner—Hi-Fi Amplifier

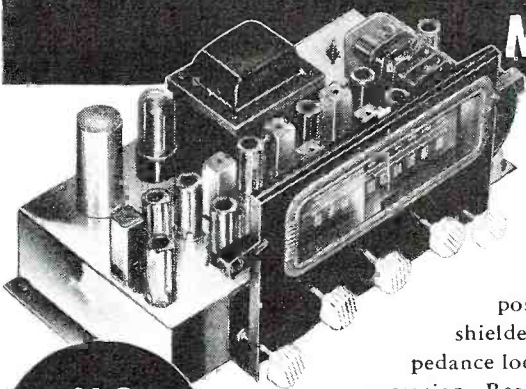

**NO  
DRIFT  
TUNER**

**A RECEIVER COMBINATION YOU'LL BE PROUD TO OWN!**

**FM-AM TUNER—RC-8** Features automatic frequency control, most revolutionary development in FM design—entirely eliminates drift and multiple tuning responses. Tuned RF stage in both FM and AM, made possible with new shock-mounted 6-section gang capacitor. Nine shielded miniature tubes plus rectifier include double limiter. Low-impedance loop, enabling flexibility in mounting, provides low-noise AM reception. Rear socket provides easy access to 6.3-volt AC and extremely well-filtered 100-volt DC for supplying external pre-amplifiers, additional pilot lights, etc. Polished chrome chassis. Complete with cable, escutcheon, decals and antennae.

**HI-FIDELITY AMPLIFIER—RC-2** High impedance input; 12 watts output at 1% distortion. Taps: 4, 6, 8, 15, 500 ohms. 65 db gain, including inverse feedback. Uniform frequency response from 20 to 20,000 cycles up to 8 watts output. Hum 65 db below rated output. Tubes: 6J5, 6SN7, (2) 6V6, 5Y3. Durable polished chrome chassis.

Write for Descriptive Circular and Prices

**HI-FI  
AMPLI-  
FIER**

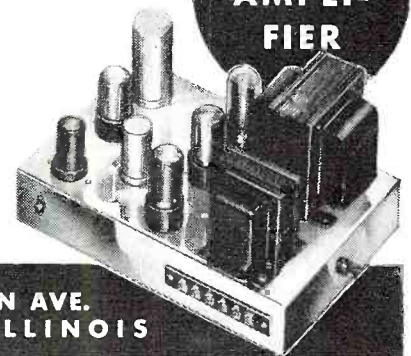

*The* **RADIO CRAFTSMEN, Inc.**

**1341 S. MICHIGAN AVE.  
CHICAGO 5, ILLINOIS**

## COLUMBIA SCOOPS THE FIELD

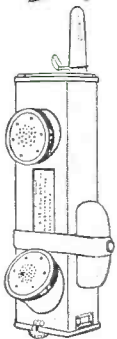

**SCR-536  
HANDY-TALKIES**  
Complete with tubes and crystals. All matched frequencies. Near new in good working condition. Less batteries.

each unit **\$29.95**

### BEAM FILTER

Aircraft Radio Range filter similar to FL-8 unit, but slanting front and two output jacks with 3-foot cord and PL-55 plug on the end. Finished in black crackle. Unit reduces QRM on phone and CW bands. Will fit any communications receiver, will pass 1020 cps eliminating others, or will pass voice frequencies and eliminate CW frequencies. Size: 2 1/4 x 5 1/4 x 3 3/4 in. \$2.95 each.

**WRITE  
FOR  
FREE  
CATALOG**

**COLUMBIA ELECTRONICS CO**  
659 S. ANDERSON ST. LOS ANGELES 23 CALIF

### OIL-FILLED CONDENSER

Cap. 1 mfd. 3600 V.D.C.  
With mounting bracket  
Rectangular can.

**\$1.95** each

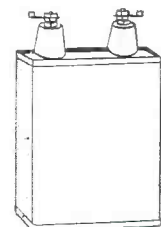

### BC 746

### TUNING UNITS

FT type, 243 crystals.  
No. 3-3995 to 4450 ke.  
No. 8-3525 to 3980 ke.  
No. 10-3735 to 4190 ke.

**79c** each

### TUBES! TUBES!

211.....	39c	811.....	\$1.59
6C4.....	29c	814.....	3.25
6AC7.....	59c	815.....	1.49
6K7.....	39c	1616.....	.79
803.....	\$7.95	8012.....	2.95

And Hundreds More!

All prices F.O.B. Los Angeles. 25% deposit with order. Balance C.O.D.

## at last! TUNABLE

### INDOOR TELEVISION ANTENNA

Completely Adjustable Multi-Wave Antenna...

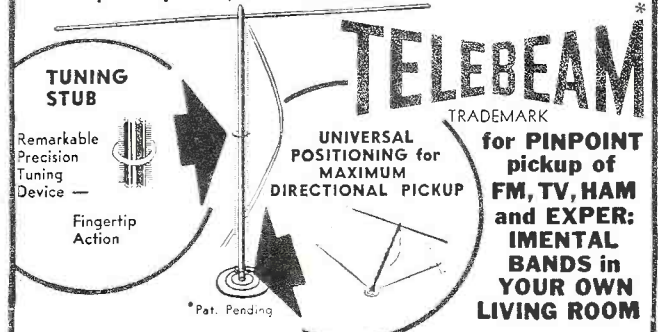

### Here's What You Get—

1. Beautiful 21 1/2" long polished wood mast—with swivel control connection to sturdy felt-padded base (no scratched furniture)
2. Tuning stub . . . movable shorting ring on two springs parallel to dipole mast.
3. 10 feet of 300 ohm twin lead-in wire plus extremely low loss ceramic insulation at connection points.
4. Antenna length adjusters . . . sturdy aluminum tubing: 2—2" rods; 2—3" rods; 2—4" rods; 10—9 1/2" rods. (Complete extra set of antenn. rods . . . only \$1.00).

Put it anywhere—on the video set, window sill, or nearby table. See how easily the mast can be rotated, moved up or down to the best angle to capture every incoming beam. See how ghosts and distortions fade away. And for minutely fine correction, just move the ring on the tuning stub for the sharpest picture attainable. Chart supplied with each antenna gives exact lengths for bands—FM, TV, Ham and Experimental Bands.

Include 20% deposit with order, balance C. O. D. Will ship prepaid if full remittance accompanies order.

**\$9.95**

COMPLETE List . . . \$14.95

*Telebeam*

The Antenna of Tomorrow — Ready for Delivery Today

**MARINO RADIO CO.**

203 Greenwich St., New York 7, N. Y.

BARclay 7-358g

# ACORN GIVES YOU WHAT YOU NEED! LOW PRICES • IMMEDIATE DELIVERY

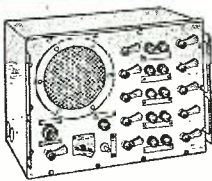

## 10 STATION INTERCOM

Brand New only  
**\$61.50**

110 volt-60 cycle AC; 16 watt push-pull output. Standard 3 wire control system. Includes all tubes, output indicator and flasher signals. Metal house substations \$5.95 each. Instruction sheets included. Shipping Wt. 60 lbs.



## PP 6L6 OUTPUT TRANSFORMER

**\$2.45 each**  
**3 for \$7.00**

Fully shielded, upright mtg., output transformer. Will handle 25 watts from push-pull 6L6's. Mtg. centers 3 3/4", 3" H. x 2 1/2" W. x 3" D. Primary 6600 ohm to 4-8-15 ohm voice coil. Shipping weight 4 lbs. Channel mtg.

## FM TUNING CONDENSER

3 gang 3-30 mmfd. with trimmers. 88-108 meg. A perfect condenser to cover FM band. 3/8 inch shaft, dimensions: w. 1 1/2", h. 2 3/4", d. 3/4". Shipping wt. 1 lb.

**\$1.10 ea., 3 for \$3**

## POWER TRANSFORMER

PRIMARY 115 volts 60 cycles SECONDARY 600v c.t. at 100 mls 6.3 v at 3 amps; 5 v at 2 amps half shell mtg. Mtg. centers 2 5/16" x 2 3/8". Made by Thordarson. Shipping wt. 5 lbs.

**Special \$3.25 ea., 3 for \$9**

## APPROVED FM FRONT-END

**\$18.95**

CIRCUIT: Superheterodyne  
TUNING RANGE: 88-108 MC  
INTERMEDIATE FREQUENCY: 10.7 MC  
AVAILABLE FOR: 21.6 MC (Television I F)  
FREQUENCY DRIFT: Negligible after 5 minutes  
3 TUBES: 6AK5 R.F. Amplifier—6J6 Oscillator, mixer, detector 6U5 Indicator (Tuning Eye)  
ANTENNA: 300 Ohm line (Dipole)—COMPLETELY ALIGNED—NO POWER SUPPLY INCLUDED—TERMINAL STRIP CONNECTOR—TUNING RATIO: 10:1—TUNED LINES: Brass silver overlay .0008 thick

## ELECTROLYTIC CONDENSERS FP TYPE IN CANS

10 @ 350v	}	...\$0.39
30 @ 300v		
20-20 @ 25v	}	.44
30 @ 450v		
20 @ 450v	}	.99
10 @ 450v		
20 @ 25v	}	.74
20-20 @ 450v		
20-20-20-20 @ 450v	}	1.29
20-20 @ 400-250v		
10-10 @ 350v	}	.59
20 @ 25v		
30-30 @ 450v	}	.79
100 @ 50v		
1000 @ 25v	}	.89
10-10-10-10 @ 400v		

## BATHTUB CONDENSERS

2.0 Mfd 600v with side terminals .....44c ea.  
10 for \$3.90

## OIL CONDENSERS

2 x .02 mfd 1500v	\$0.69
1 mfd 3500v	.79
1 mfd 7500v	1.79
.25 mfd 3000v	1.19
.15 mfd 4000v	1.39
.5 mfd 5000v	1.89
1.0 mfd 2000v	1.29
1.0 mfd 1200v	.99
4.0 mfd 1000v	.89
1.0 mfd 900v	.45
1.0 mfd 600v	.79
1.0 mfd 400v	1.39
8-1 mfd 1000v	1.39
1.0 mfd 900v	.89
15 mfd 1000v	1.89
1.0 mfd 330vAC/100vDC	.39
1.5 mfd 330vAC/100vDC	.39

## TLA OIL FILLED

4.0 mfd. 900v	\$1.49
2.0 mfd 1000v	1.39

a colored plastic cabinet which has a leather textured surface on both the front and back panels and a simulated leather handle ornamented with Richlo brass.

The portable has five tubes and a dry disc selenium rectifier, a built-in "Beam-a-scope" antenna and a four-inch "Dynapower" speaker.

For further information on the Model 150, write the Receiver Division, General Electric Company, Electronics Park, Syracuse, New York.

## THE "AMERICANA"

A custom-built table model television receiver which features a dual-purpose transparent mirror, has been



introduced by The Sightmaster Corp. of New York.

Designated the "Americana," this set has the company's "Sightmirror." When the set is on, the "Sightmirror" acts as a soft polaroid filter which enhances the picture quality and reduces glare, according to the company. When the set is off, the "Sightmirror" becomes a mirrored front for the receiver.

The unit has a 15 inch direct view picture tube which provides 120 square inches of picture space. The set also uses 24 additional tubes.

The Sightmaster Corp., 220 Fifth Avenue, New York 1, New York, will supply additional details on request.

## PROJECTION TV

Cortley Television Corporation is currently marketing a projection tele-

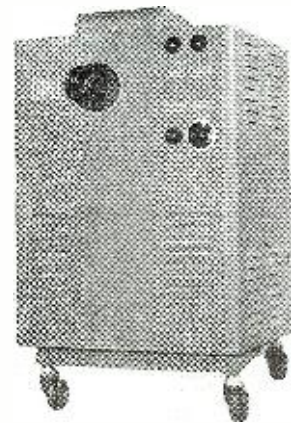

vision unit which is capable of producing a picture of any size from several inches up to 6 by 8 feet.

The set is designed to meet the re-

**ACORN ELECTRONICS CORP.**  
80 Vesey St., Dept. R-9, New York 7, N. Y.

TERMS: 20% cash with order. Balance C.O.D. All prices F.O.B. our warehouse in New York City. No orders under \$2.50.

## SCOOP-SCHUH DOES IT AGAIN!



## 10 METER 3-ELEMENT BEAM ANTENNA

- Adjustable telescopic elements.
- Adjustable spacing—can be set for .1-15 or .15-.2
- 2 Types: T Match Folded Dipole
- Rigid Aluminum construction to withstand high winds.
- Easily fed with coax cable or mounded line.
- Fits 1" pipe mast (not included).

Look At This Low Price

T MATCH BEAM.....	\$19.95
FOLDED DIPOLE BEAM.....	23.95
15' length RGSU coax cable with connector on each end.....	\$5.69
300 Ohm Mounded line per 100 feet.....	\$2.75

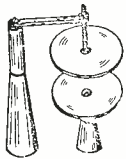

## HI POWER NEUTRALIZING CONDENSER

Easily mounted on chassis by drilling 2 holes. 3/4" aluminum discs with brass hardware. Capacity 3-15 mmfd. Height 5/4".

Only.....**\$1.50**  
8 mfd 2500 Volt Oil Filled Condensers.....**\$4.50**

Write for free Merit Transformer Catalog—low price, high quality.

TERMS: 30% With order. Balance C. O. D. Shipments F. O. B. Chicago

## SCHUH'S RADIO PARTS

1253 Loyola Avenue • Chicago 26, Illinois

## SAM'S SURPLUS

FL-8 Audio Filter.....	\$1.39
BC-459 7-9.1 Mc.....	\$12.95

ARC/5 7-9.1 Mc.....	\$7.95
ARC/5 4-5.3 Mc.....	\$5.95
Spec., both for.....	\$11.95

BC-454 Rec.....	\$6.95
MD/7 ARC/5 Mod. P.P.....	\$7.95
BC-456 Mod.....	\$3.95

## TRANSFORMERS (SPECIAL)

3200 V. 300 Ma. No C.T.....	\$8.95
Two for.....	\$15.95
250 V. D.C. 150 Ma. 6.3 & 5.....	\$3.95
6.3 V. 15 A.....	\$3.95
12/24 V. 2 A.....	\$2.95

## TUBES

75TL.....	\$2.95
VT127A.....	\$2.95
304TL.....	\$0.97
810.....	\$4.95
860.....	\$4.95
861.....	\$9.95
872.....	\$1.19

## FILTER CONDENSERS

2 Mfd. 4000 V.....	\$3.95
3 Mfd. 4000 V.....	\$5.95
2 Mfd. 5000 V.....	\$6.95

Crystal Special—5675 to 8650 Kc., 25 Kc. steps, any 6 for.....\$5.00

## ESEGE SALES CO., Ltd.

1306 BOND STREET

LOS ANGELES 15 • CALIFORNIA

quirements of commercial establishments, institutions, etc., which require large size television images for audiences numbering into the hundreds.

The unit features tilt adjustment for different height screens, a focus adjustment which is easily accessible for different length throws, switch for front and rear projection pictures, a refractive type of optical system, and an automatic cut-out relay to prevent damage to projection tubes.

Further information and details may be secured by writing to *Cortley Television Corporation*, 15 West 27th St., New York 1, New York.

#### COLUMBIA TV UNITS

*Columbia Television, Inc.* is now in production on four table model receivers all of which are housed in new and compact cabinets designed by Glen Holland to fit the decor of any home.

The four models have been designated the Models 10 TV, 12 TV, 10 FM,

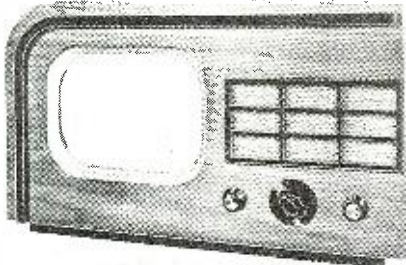

and 12 FM. The first two sets provide television and FM sound only, while the last two receivers provide full FM radio reception from 88 to 108 mc. in addition to television coverage.

All of the sets feature only three controls, full coverage of all 12 television channels, a newly designed a.f.c., a special audio amplifier circuit which is said to minimize distortion, a special picture amplifier, 26 tubes including 3 rectifiers, standard RMA approved parts throughout, and simplified design which permits faster servicing.

For additional information on any or all of these receivers, write to *Columbia Television, Inc.*, Receiver Division, Stamford, Conn.

#### A.C.-D.C. VIDEO SET

*Belmont Radio Corporation* of Chicago, a subsidiary of *Raytheon Manufacturing Company*, has announced production of a universal television

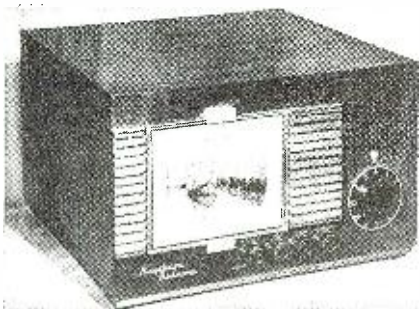

September, 1948

# Modern Hams Junk Old-Style "Cans"!



First basic improvement in headset design in 50 years

## TELEX MONOSET

- Gives clear, crisp "near as here" reception
- Blocks outside noise
- Eliminates that "top-heavy" feeling
- Ends headachy ear pressure

Man, what relief to get rid of those pressure headaches from old-style earphones!

The TELEX MONOSET swings lightly under the chin like a stethoscope—never gets in your hair! The TELEX MONOSET delivers the signal into the ears, excludes all room noise automatically. The TELEX MONOSET gives undistorted output at maximum volume... plenty of "sock" easily adjusted with the built-in volume control.

Modernize your rig with a MONOSET—successor to the earphone! Write Department BT for information.



Canadian Distributors

Sono Film, Ltd., Winnipeg

## RADAR TECHNICIANS—WANTED

FOR OVERSEAS ASSIGNMENTS:

#### Technical Qualifications:

1. At least 3 years practical experience installation and maintenance.
2. Navy veterans ETM 1/c or higher.
3. Army veterans TECH/SGT or higher.

#### Personal Qualifications:

1. Age over 22—Must pass physical examination.
2. Ability to assume responsibility.
3. Must stand thorough character investigation.
4. Willing to go overseas for 1 year.
5. No dependents permitted overseas.

Base pay, bonus, living allowance, vacation, add up to \$7,000.00 per year. Permanent connection with company possible.

APPLY BY WRITING TO

R-59 P.O. BOX 3414, PHILADELPHIA 22, PA.

Give complete history of your experience, particularly in radar maintenance. Interview will be arranged for successful applicants.

**You Can't Match these  
MID-AMERICA Values!**

**Transformer Scoops!**

Transformers listed are full-shell type, upright mounting. Color coded leads. Brand new! Quantities are limited—so order now!



**MA-2510**—Power Transformer 850 VCT, 200 MA; 5V, 3A; and 6.3V, 5A, 4½" x 4" x 3¾". Regular list \$12.75. Now only, **\$4.95 ea.**

**MA-2523**—Driver Transformer #16 to PP 6L5, Class AB2. Rated 40 M.A. Tri-Primary current, 3" x 2½" x 3". A \$3.75 value. Mid-America's value price. **\$1.69 ea.**

**MA-2521**—Filament Transformer 115 V, 6-cycle primary, 6.3V, 3A secondary, 3" x 2½" x 2½". **\$1.49 ea.**

**Amazing FM Antenna**

**Model A-100** for use indoors—eliminates trouble of erecting outside antenna. Tunes 88-108 MC band with excellent signal gain. May be mounted on wall or out of sight under rug. Complete with twin lead-in cable; merely connect to receiver antenna posts. Brand new in original factory cartons. Shipping wt. 1 lb. **\$1.49 ea.**

**CONVERTERS!**

These famous-make converters have never before been offered at these low prices! All are brand new, complete, ready for immediate installation and operation. Quantities are limited; get your order in NOW!

**32-Volt DC to 115-Volt, 60-Cycle**

**Model 102.** Rated 100 watts. Gray wrinkle-finish metal cabinet with ventilating louvers and bumper feet; measures 6¼"x8½"x4". Has outlet receptacle, line cord and plug. Circuit is fused for overloads. On-off switch. A sturdy, dependable unit for many applications. Shipping weight 15 lbs. **\$17.95**

**Model 2115B.** Dual output for operation of both radio and appliances; rated 100 watts. Streamlined metal case with smooth brown finish and chrome carrying handle. Complete with line cord, plug and overload fuse. On-off switch. Especially good for farm use. Measures 6"x8½"x6¼"; shipping weight 15 lbs. Regular \$60 list. **\$22.95**

**Model 146.** Heavy duty converter with battery cable and clamps. Ventilated cabinet with wrinkle gray finish; bumper feet. On-off switch, two outlet receptacles. Rated 350 watts. Measures 9¾"x15½"x7". Shipping weight 55 lbs. **\$59.50**

**115-Volt AC to 12-Volt DC**

**Model 2752.** For operation of 12-volt DC equipment and for trickle charge of batteries. Rated 120 watts. Trim metal cabinet with ventilating louvers and bumper feet; smooth gray finish. Fused for overloads. Line cord, plug, on-off switch. \$16"x8½"x6½"; shipping weight 22 lbs. Regular \$59.95 list. **\$15.95**

**115-Volt DC to 115-Volt, 60-Cycle**

**Model 267.** Small unit for operation of clocks and other small motors. Rated 5 watts. Measures only 9"x2½"x2", shipping weight 3 lbs. Enclosed in smooth gray metal case. Has line cord and outlet receptacle. Regular \$16.95 list. **\$5.95**

**12-Volt DC to 115-Volt, 60-Cycle**

**Model 2774.** Compact unit measures only 7"x5"x2½". Rated 12 watts; fused for overloads. Smooth gray-finish metal case with mounting brackets. Regular \$49.95 list. **\$17.95**

**TERRIFIC SAVINGS ON  
CERAMIC GRID CAPS**

¾" clamp to fit 807, 2X2 and other popular tubes. Made by a famous manufacturer. Regular 21c. Get your share while they last at this sensational low price. **MA-2234, 6 for 79c**

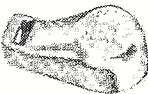

**Order from this Ad**

Quantities on above-listed items are strictly limited! You must act fast to make sure you get what you want. Send 25% deposit. Pay balance plus postage on delivery. Get your name and address on Mid-America's select mailing list to receive monthly bargain bulletins that give you first crack at the latest, greatest, money-saving buys in radio parts, electronic equipment, tubes, etc. Send orders and mailing list data to Desk E-98

**MID-AMERICA CO. Inc.**

2412 S. Michigan Avenue  
Chicago 16, Ill.

receiver which will operate on a.c. of any frequency in addition to d.c.

The new unit eliminates the need for converters in d.c. areas. The receiver is a table model with a 7" direct view video screen. The cabinet is of genuine mahogany and measures 17" x 16" x 10". The set weighs 30 pounds and uses 17 tubes plus one rectifier tube. Complete coverage of both television bands and all 13 station channels is provided.

The receiver will be marketed under the tradename "Raytheon-Belmont" and retails in the moderate price class.

Further details on the universal television receiver may be secured by writing Belmont Radio Corporation, 5921 West Dickens Avenue, Chicago 39, Illinois.

-30-

**RADIO TELEPHONE FOR CENTURY**

THE nation's longest stretch of train radio telephone service, on the 436 mile run between New York City and Buffalo, will be inaugurated by the New York Central when the new Twentieth Century Limiteds go into operation.

Radio telephone service will be extended the remaining 525 miles westward along the Central main line through such cities as Erie, Cleveland, Sandusky, Toledo, South Bend, and Elkhart as soon as sufficient telephone radio stations are available along the railroad.

The new service is scheduled to be the first railroad operation on the channels assigned to general highway mobile radio use in the 30-44 mc. band. Calls to and from the Century will be routed through the nearest of nine fixed stations between New York City and Buffalo. Transmissions from the Century will be on a different frequency than similar transmission from fixed stations to the train.

The fixed stations are located at New York, Mt. Kisco, Poughkeepsie, Guilderland, Fonda, Utica, Syracuse, Rochester, and Buffalo. All except the Fonda station are operated by the Bell System companies.

The cost for this service ranges from a minimum of 30 cents in the local area through which the train is passing to the regular person-to-person day rate for all calls, day or night, outside the local area, where a 45 cent minimum applies.

-30-

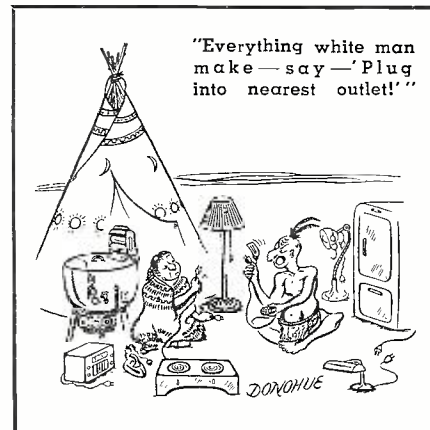

here is an ideal  
**PORTABLE  
microphone  
stand**



- Weighs only 3½ pounds
- Adjustable from 2 ft. to 6 ft.
- Designed for floor or banquet table use
- Easily carried in amplifier or speaker case
- Beautiful chromium and hammerloid finish

List Price \$10.00

Your cost \$6.00 PREPAID

MAIL ORDERS WELCOME

**RADIO PRODUCTS SALES CO.**  
1237 16th St. Denver 2, Colo.



- ★Wide-Range
- ★Scratch
- ★Suppressor
- ★Volume Expander

Supreme performance with any variable reluctance pickup.

**EXCLUSIVE G.E. PICKUP CIRCUIT**

New circuits enable you to attain full benefit from the new G-E Variable Reluctance Magnetic pickup. Employs an exclusive, humless pre-equalized pre-amplifier to produce the most satisfying musical amplifier the world has ever known. If you are a perfectionist, you are the one for whom the ACA-100GE was designed. Send for technical literature.

**AMPLIFIER CORP. OF AMERICA**

398-2 Broadway, New York 13, N. Y.

**Mass. Radio School**

273 Huntington Ave., Boston 15, Mass.

Offers Training Courses for Radio Technician (Pre-Television) and Licensed Radio Operator (All Types) including maintenance and operation of General Electronic Equipment. Over 20,000 Alumni and 28 years radio training EXPERIENCE. Courses approved for G. I. Training for Veterans.

Licensed by Commonwealth of Mass. Department of Education

## Hi-Fi Amplifier

(Continued from page 47)

crease the high frequency response.

The condenser  $C_3$  and resistor  $R_3$  control the bass equalization by presenting a variable grid impedance at different audio frequencies. At high frequencies the reactance of  $C_3$  is low compared to  $R_3$  and the grid impedance is low giving a lower gain than at low frequencies where the reactance of  $C_3$  is high compared to  $R_3$ . Varying these values will allow the constructor to adjust the equalization to his own particular likes and dislikes. However, the authors recommend using the circuit as shown and varying these circuit values only if the response does not please the ear.

A transformerless power supply using a 200 milliamperere selenium rectifier supplies both "B plus" and d.c. heater voltage. The d.c. heater voltage and the "B plus" for the 50B5's is taken off before the choke. This allows a choke of a lower current rating to be used. "B plus" filtering for the remaining tubes is accomplished by condensers  $C_{17}$ ,  $C_{18}$  and  $C_{19}$ , choke  $CH_1$ , and resistor  $R_{25}$ . No extra bleeder resistor is used since the d.c. heater string provides an excellent low resistance bleeder for the high capacitance filter condensers. Filtering for the d.c. heater string is needed only in the 6C4's and is provided by  $C_5$ . The remaining heaters are operated from a midget 6.3 volt filament transformer mounted beneath the chassis.

A note of caution is necessary in connection with this power supply. The chassis was utilized as a common ground connection, and is therefore directly connected to one side of the 117 volt a.c. line. The authors mounted the completed unit in a wooden cabinet where danger from shock could be avoided. If this is not done then a common ground wire should be used, consisting of a piece of bus bar running the length of the chassis and insulated from it at both ends by means of terminal strips.

Another alternative is to use a single wire a.c. plug and a water pipe ground. If this method is decided upon merely remove the one a.c. line cord lead from the chassis to the plug and replace it by wire from the chassis to a good ground such as a water pipe or radiator. Do not use a gas pipe since these are sometimes insulated at the meter. The switch  $S_3$  should then be placed in the opposite lead. Using this method the amplifier will operate only if the a.c. plug is inserted correctly in the socket.

The current requirements are somewhat greater than recommended for the selenium rectifier being used, but in the original model no signs of overheating or deterioration have appeared even after extended periods of use.

The amplifier was constructed on a

This handy, pocket-size SALES-KIT holding six Jensen phonograph needles is just the thing for Radio Servicemen to take on service calls. Contains 3 of the famous Jensen Royal Jewel Genuine Sapphire needles retailing at \$2.50, and 3 of the Jensen Classic needles at \$1.50. It helps demonstrate fine needles, sells on sight, adds \$\$\$ to your income. Needles are individually packaged in gold, red and black containers. What's more Jensen needles assure full, clear tone of the instruments you repair, make all records sound better.

Mail us your order for one SALES-KIT at \$6.00 with the name of your distributor and a \$1.50 Jensen Classic Needle will be sent to you FREE.

JENSEN INDUSTRIES, Inc., 327 SOUTH WOOD ST. • CHICAGO 12, ILL.

## THE NEW MODEL 40 UTILITY TESTER

# UTILITY TESTER

### ACCURATELY TESTS

RANGES • VACUUM CLEANERS • SHAVERS  
 AIR CONDITIONERS • HEATERS • REFRIGERATORS • IRONERS • SUN LAMPS  
 WASHERS • TOASTERS • FANS • WASHING MACHINES and MOTORS

ALL MOTORS—single phase, multi-phase, universal, squirrel cage, induction; in fact, every type of motor from fractional H. P. to 2 H. P.

**THE MODEL 40 UTILITY TESTER**

Will indicate whether voltage is 110 Volts or 220 Volts, if current is A.C. or D.C. and if frequency is 25 cycles or 60 cycles. Will test Thermostats under actual working conditions. Will measure the actual current consumption of any appliance, either A.C. or D.C., while the unit is in operation—reading will be direct in amperes—the appliance or utility may be plugged directly into front panel receptacle—a special pair of insulated clip-end leads is provided for motors. Incorporates an ultra-sensitive direct reading resistance range which will accurately measure all appliance and utility resistances down to a fraction of an ohm. Will test bulbs, fuses, condensers, field coils, etc. Is ideal trouble shooter as it will instantly locate opens, shorts and grounds. Will locate cause of failure in three-way heat control switches. Will indicate when one side of an appliance or motor comes housed in a rugged crackle finished steel cabinet with portable cover.

Model 40 Utility Tester comes housed in a rugged crackle finished steel cabinet with portable cover.

**\$15.75**

Complete with all test leads and operating instructions

20% DEPOSIT REQUIRED ON ALL C.O.D. ORDERS  
 GENERAL ELECTRONIC DISTRIBUTING CO.  
 Dept. RN-9 98 Park Place New York 7, N. Y.

# NEW SURPLUS SPECIALS

## RECTIFIERS—DRY DISC TYPE

Continuous Duty Ratings

3.5 V.A.C. 1.8 V.D.C. 1.0 Amp. Full wave bridge.....	<b>50.90</b>
6.5 V.A.C. 2.2 V.D.C. @ 3.0 Amps. Full wave center tap.....	<b>1.20</b>
36 V.A.C. 200 Mil D.C.H.W.....	<b>.75</b>
36 V.A.C. 2.2 Amps D.C. Full wave bridge.....	<b>3.75</b>
54 V.A.C. 1.6 Amp. D. C. G. E. Full wave bridge.....	<b>4.40</b>
154 V.A.C. 600 Mil. D.C. Full wave bridge.....	<b>6.85</b>
180 V.A.C. 400 M.A. D.C. G.E. Full wave bridge.....	<b>6.90</b>

## PE-95G GASOLINE GENERATORS

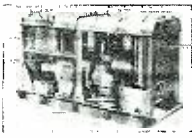

10 KW. 100% P.F. 120/240 V. 60 cycle Single phase remote start. New—Export packed—w/spares, tools. Gr. wt. 2128. Cu. 70.... **\$850.00**

Onan Gasoline Generator Type CDO-73004-A (for TBW Radio Equip.) 120 V. 800 cycle, Single Phase @ 9.8 Amps 14 V.D.C. @ 20 Amps. New in watertight metal case..... **\$140.00**

## CONDENSERS

• 150 Mfd 50 V. Dry Electrolytic.....	<b>50.40</b>
• 500 Mfd 200 V. Dry Electrolytic.....	<b>.95</b>
• 2 Mfd 600 V. Tubular oil.....	<b>.39</b>
• 10 Mfd 600 V. oil.....	<b>.95</b>
• 5.0/5.0 600 V. Pyranol.....	<b>1.05</b>
• 4 Mfd 1000 V. oil.....	<b>.90</b>
• 2 Mfd 2500 V. oil.....	<b>2.40</b>
• 50 Mmf 32 K.V. Tubular Vac. Jenning #VC-50.....	<b>4.95</b>
• 250/250 Mmf 3000 V. Variable Bud #BC-1623....	<b>5.75</b>

## TRANSTATS

• *115 V. 50/60 cycle input 103-126 V. output @ 2.17 Amps.....	<b>\$9.95</b>
• 115/230 V. 50/60 cycle input 0-260 V. output @ 2 1/2 amp.....	<b>21.50</b>
• *GR Variae, 115 V. 50/60 cycle input 0-135 V. output @ 5 Amps. Cased.....	<b>14.50</b>
• 115 V. 50/60 cycle input, 0-135 V. output @ 10 Amp.....	<b>24.50</b>
• *0-115 V. @ 100 Amp. or 230 V. @ 50 Amps. 11.5 KW.....	<b>\$75.00</b>

## TRANSFORMERS

• Power 80-110-220 V. Pri. 50-1600 cycle 422 V. 25 Mil. C.T. @ 6.3 V. 3 Amp. Secondary....	<b>1.25</b>
• 110 V. 24 V. @ 1.0 Amp. Uncased.....	<b>1.60</b>
• Mic input double carbon, 18-6000 ohms....	<b>.70</b>

\* Removed from new equipment.

BC-342 N Receiver 6 band 1500-18000 KC 110 V. 60 cy..... **\$92.50**

BC-344 D Receiver, 4 band 150-1500 KC..... **\$92.50**

Telescoping Antenna AN-75B 1 3/4" to 7' solid brass clamp on..... **\$1.25**

Thermostat switch, Fenwall, -50° +400° F. 110/220 V. 2500 Watt contacts, adjustable..... **\$1.60**

K.V. Meter Multiplier resistor meg 1/10% Non-inductive w.w..... **\$1.25**

2 D21 Miniature Thyatron..... **5 .70**  
750 TL Transmitting Triode..... **42.50**

Sound power phones Navy type Complete w/microphone, headset 50' cord..... **\$4.95**

No Orders Under \$3.00 Please  
30% With Order Balance C.O.D.  
All shipments made Express Collect.  
Write for additional information on above items or for Special Quantity Discounts.

# EPCO

1527 E. SEVENTH ST.  
LOS ANGELES 21, CALIF.

# RADIO

Technician and Radio Service Courses  
**FM and TELEVISION**

American Radio Institute  
101 West 63rd St., New York 23, N. Y.  
Approved Under GI Bill of Rights  
Licensed by New York State

# MICROPHONES

Unbreakable dynamic—adjustable impedance  
**SOUND ENGINEERS BUY DIRECT**

**50% discount**

off the regular list price  
SEND FOR FREE CATALOG

**ST. LOUIS MICROPHONE CO.**

2726 Brentwood Blvd. St. Louis 17, Mo.



# RADIO INSTITUTE

Outstanding PRE-WAR Technical

Training Center for

# TELEVISION & RADIO

Under the personal direction of Frank Melville, former Airlines, Merchant Marine, and Broadcast technician, you may soon qualify as:

- RADIO TECHNICIAN
- AIRLINES RADIO OFFICER
- PT. TO PT. TELEGRAPHER
- RADIO AMATEUR
- MERCHANT-MARINE RADIO OFFICER
- TELEVISION TECHNICIAN
- HOME RECEIVER REPAIRMAN
- VISUAL TELEGRAPH OPR. (SLIP TAPE)

MELVILLE RADIO INSTITUTE believes vocational training means vocational training. Thus we, like many radio schools, teach ample theory. But, unlike most schools, two-thirds of our technical students' time is spent in laboratories and shops, where, with superior equipment, they learn by doing—not memorizing.

FREE employment service is available to all MELVILLE graduates.

Visit the 10-story MELVILLE Building today as our guest and observe the school in operation.

Day and evening classes approved for veterans. Licensed by the State of New York.

**MELVILLE RADIO INSTITUTE**  
Melville Building

15 West 46 St., N. Y. 13 • LUXemburg 2-0440

**MAIL THIS COUPON NOW!**

MELVILLE RADIO INSTITUTE R N  
Melville Building  
15 West 46th St., New York 19, N. Y.

Gentlemen: Send me Free information about your school.

Name.....

Address.....

10 by 5 by 3 inch chassis. The general placement of parts is clearly shown in Fig. 1. The selenium rectifier, together with the 50/50/50  $\mu$ fd. and 500  $\mu$ fd. condensers, is mounted on the extreme left. The 50B5's are mounted to the right of the filter condensers followed by the 6C4's. In the front, from left to right, are mounted the 6J6, 9003, and 6AG5. The 6AL5 is placed in front at the extreme right.

Seven-pin miniature bakelite sockets were used for all the tubes, except the first preamplifier tube where a shielded socket was used to prevent hum pickup in this low-level stage. The metal ring in the center of each socket was grounded to provide additional shielding.

The controls along the front edge are from left to right; the "off-on" switch, volume control, and "expand-compress" control. The input jacks, together with the output plug, are located along the rear edge. The high-level input jack is on the left. The choke and 6 volt filament transformer are mounted underneath the chassis on the left hand edge.

The a.c. heater wiring should be done with twisted leads to avoid hum pickup. After wiring the filament circuit, it should be tested before completion of the other wiring. Next, the phase inverter and power tube should be wired and tested. If this method is followed, i.e., wiring each stage and then testing, any errors made will be discovered while it is still easy to make the necessary corrections.

Audio leads, especially in the pre-amplifier stages, should be made point-to-point and dressed down against the chassis wherever possible.

The resistor network for the floating paraphase inverter consisting of  $R_{13}$ ,  $R_{19}$ ,  $R_{20}$ ,  $R_{21}$ , and  $R_{22}$  was mounted on a small terminal board between the 6J6 socket and the 50B5 sockets. It is hidden from view by condensers  $C_{12}$  and  $C_{20}$  which lie directly over it and make for a very compact arrangement. Several of the other resistor-condenser networks were mounted on

Fig. 4. Frequency response curve of amplifier. 1000 c.p.s. is taken as 0 db. reference.

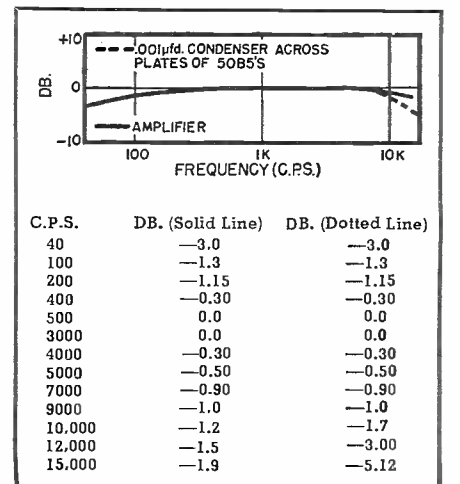

terminal strips and are identifiable in the photographs.

### Operation

After wiring has been completed, the amplifier is ready for operation. The output connections should be made through the 3-pin plug in the rear of the chassis, an input source plugged into one of the jacks and the amplifier turned on. *Caution:* The output connection must be made before turning on the amplifier or the 50B5 tubes may be damaged. Without the output plug in position, screen voltage is applied to the 50B5's without plate voltage which results in high screen dissipation and may damage the 50B5's permanently.

Should any smoke or abnormal behavior appear after the amplifier has been turned on, it should immediately be turned off and the wiring of the affected circuit carefully checked.

After it has been ascertained that the amplifier is operating properly, the only adjustment necessary is to set  $R_{11}$  to apply about 1 volt of audio to the grid of the 9003; this may be measured by a good a.c. vacuum-tube voltmeter or simply judged by listening for the overload level of the 9003 which occurs at about 1.5 volts. The 1 volt setting allows some slight margin for high level peaks.  $R_{12}$  should be adjusted to give the degree of expansion or compression desired. When set in the center of its range, normal amplification without expansion or compression is available.

Only one other point remains to be considered: the lack of a tone control of any kind. The authors have used this amplifier in conjunction with a 12 inch dynamic speaker in a bass-reflex cabinet, and feel that for high fidelity reproduction no tone control is necessary. The amplifier has been used with low-level pickups of the magnetic type, high level crystal pickups, and several types of FM and AM tuners and the reproduction has been satisfactory at all times. If the constructor desires, any of the more common tone control circuits may be included in the amplifier.



# FREE NEWARK TV SERVICE

Newark Does It Again — with the Installation of a Complete

## TELEVISION SERVICE DEPT

Yes, in each store Newark will have this elaborate RCA Test Equipment (as featured in July Radio News) to completely align and test the TELEVISION KIT YOU BUY AT NEWARK!

This is the "last word" in TV Service... It makes available to you the latest designs in Television Test Equipment to get top performance from the kit you assemble. You can do a complete job of Alignment and Testing under the guidance of a Trained Television Technician.

Don't miss the chance to take advantage of this FREE SERVICE! There is no substitute for the best test equipment, to get maximum performance from any television set.

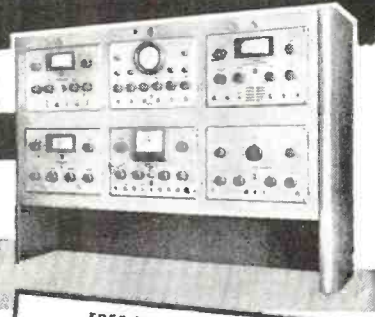

**FREE TO OUR PATRONS**  
Expert Advice and Free Use of this Laboratory to all Purchasers of Television Kits from NEWARK.

### Terrific Television Buy!

#### Tech-Master 630-TK 10" Kit

**\$198.50**

Complete with 30 RCA Tubes including 10BP4

This is exact copy of famous RCA 630TS Television set. Contains efficient RCA front end 13-channel tuner — completely factory wired and aligned. Can substitute 12" or 15" tube for 10BP4 if desired. Dual controls for picture and FM sound, and for horiz. and vert. control. Kit supplied complete with 30 RCA matched tubes, and RCA schematic and service manual, but less wire, solder, and mtg. screws. Shpg. wt. 85 lbs.

Cat. No. A-19752..... Your Cost \$198.50  
\$39.70 down, 12 months at \$14.03

Hand Rubbed Walnut Cabinet  
No. A-19753..... \$42.50



### IMPROVED Electro-Tech 7" TELEVISION KIT

**\$59.50**

Complete with 13 channel Tuner, Less Tubes

It really works fine! Easy to assemble. Latest circuit refinements. 17 tubes incl. 7JP4, pre-tuned IF coils, new high volt transformer, FM sound. Complete step by step instructions included. Wt. 25 lbs.

Cat. No. A-19521..... \$59.50  
Kit of 17 tubes incl. 7JP4..... 33.97  
Cat. No. A-19523 7" Cabinet..... 21.00

10" TELEKIT — Uses 10BP4 tube and additional refinements. Wt. 35 lbs.

Cat. No. A-19522..... \$99.50  
Kit of 19 tubes..... 51.50  
Cat. No. A-19524 10" Cabinet..... 23.50



### NEWARK TV ANTENNAS

Cat. No. A-30400 Covers all 13 channels. Hi and Lo freq. arrays use hairpin dipole and refl. elements. 5-ft. alum. mast with hdwre. and instr. Shpg. wt. 10 lbs. Complete..... **\$9.71**

5-ft. ext. mast and coupler for above Cat. No. A-30402..... \$2.55

Hi Freq. Attachment (for channels 7-13) mounts on any lo freq. antenna. Complete with 14" mast and hdwre. Shpg. wt. 5 lbs. Cat. No. A-30401..... \$3.83

### FREE! NEWARK'S NEW CATALOG

Brand new—Just off the Presses—132 Pages crammed full of the Biggest Radio, Electronic, Television and Sound Values!

**WRITE FOR YOUR COPY TODAY!**

Send Orders To  
242 West 55th St.  
New York 19, N. Y.  
or  
323 W. Madison St.  
Chicago 6, Ill.

**NEWARK CHICAGO**  
323 W. Madison St.  
Chicago 6, Ill.

**NEWARK ELECTRIC COMPANY, INC.**

New York City Stores: 115-17 W. 45th St. & 212 Fulton St.

### CORRESPONDENCE COURSES IN RADIO and ELECTRICAL ENGINEERING

**ELECTRICAL ENGINEERING** Get a good grasp of wide electrical field. Prepare yourself at Low Cost, for secure future. Modern course. So simplified anyone can understand quickly.

**RADIO ENGINEERING** Extra fine course in radio, public address, photo-electric work. Trains you to be super-service man, real vacuum-tube technician. Servicemen needed badly. Diploma on completion. Many graduates earning big pay.

**WRITE** Send postcard for Free Copies of \$25 Either school catalog, full details, all courses about deferred payment plan, experimental kits, etc.

LINCOLN ENGINEERING SCHOOL, BOX 931-R117 LINCOLN 2, NEBR

Assemble World's Smallest **"POCKET TALKIE!"** for as low as \$9.95

**REALLY WORKS**—talk and hear 2-10 miles or more—**FITS IN YOUR POCKET!** Uses flashlight batteries. ABOUT SIZE OF 2 PACKS CIGARETTES! Wt. 1 LB!

**SEND ONLY \$1.00** (cash, check or MO) or pay postman \$1.52 C.O.D. for photos, picture blueprints, instruction book, parts price list with INSTALLED CATALOGUE ON 135 OTHER PRODUCTS SUCH AS: (\$1.00 allowed on parts order)  
3-tube Pocket Radio, Under Dash Car Transmitter, Ignition Box, Vacation Transmitter, Radio Garage Door Openers, Electronic Burglar Alarms, 3-tube Hearing Aids!

**MOTOR INDUSTRIES CO., Dept. RW-9, Kearney, Neb.**



**STEADY PROFITS**

**YOUR OWN BUSINESS with CORADIO**

THE COIN OPERATED RADIO

Place these specially built radios that play 1 or 2 hours for 25c in the thousands of available hotel rooms, tourists courts, etc. They yield immediate profits and steady income. Install Coradio, the finest made.

Limited capital required. Send for further information. Write today.

**CORADIO** Coin Operated Radio  
Dept. R. N. New York 7, N. Y.  
212 Broadway Phone: Beekman 3-0038-9

**WHERE TO BUY IT . . . . .**  
**WHOLESALE RADIO**  
of Baltimore

**QUALITY**  **PRODUCTS**  
**THAT ARE STILL**  
**SMASHING SALES RECORDS**

**FAMOUS G-E 1201** **\$17.70**  
25 WATT

**DELUXE ALNICO 5**  
**14.5 OZ. PM SPEAKER**  
**50-13,000 CYCLES**  
Also we have a complete line of G-E aluminum foil base voice coil PM speakers from 4" to 12"—ideal for home, auto, or outdoor use.



**NEW!** **VERSATILE!**  
**EFFICIENT!**  
**G-E MODEL YTW-1**  
**TUBE CHECKER**  
**ONLY \$49.50**  
★ ★ ★



Checks all the newest tubes, quickly and accurately. Roll scale chart, quick short test, large fused meter (4 7/8" x 4 1/8") in a durable steel portable case. G-E Quality throughout—

**OTHER G-E PRODUCTS**

- New Germanium Crystal Diode.
- Model 32C406-G5 . . . . . \$1.60
- Variable Reluctance Pickup.
- Model RPX010 . . . . . \$4.77
- Pre-Amplifier (for V.R.P.).
- Model SPX-001 . . . . . \$5.94
- 3 inch Oscilloscope.
- Model CRO-3A . . . . . \$98.50

**ACCLAIMED**  
by **MUSICIANS** and  
**ENGINEERS**

**MEISSNER**  
**MODEL 8C**  
**FM TUNER**  
**\$38.33**



**TRY US FIRST**

We can supply you immediately from our large inventory of Radio Components and Equipment.

**TV'S SENSATIONAL KIT!!**

**NOW**  
YOU CAN BUY THE  
**FAMOUS 10" RCA**  
**MODEL 630 TV SET**  
**IN KIT FORM**  
With easy to follow  
instructions  
**COMPLETE (Less Cabinet)**  
**NOTHING ELSE TO BUY \$198.50**



WRITE DEPT. QR-73 TODAY FOR OUR  
**FREE MONTHLY "FYI" BULLETIN**  
Phone—MUIberry 2134

**WHOLESALE**  
**RADIO PARTS CO., Inc.**  
311 W. Baltimore St.  
**BALTIMORE 1, MD.**

**Surplus Hound**  
(Continued from page 57)

would have saved \$1790.05. This time I found a set of storage batteries at a bargain, although not quite as colossal a bargain as the transmitter. These were priced FOB, but it didn't say FOB where. The surplus house was only a few hundred miles away, so the freight probably wouldn't be much. When the batteries arrived two months later, I discovered there had been an omission in the ad—it should have read "FOB Guam." There was a second financial crisis before the freight was paid, again with the assistance of an unsuspecting neighbor. And, we saved another \$17.98 on a new dress to keep peace in the family.

Next I had to have a generator to charge the batteries. I could do it cheaper than using power from the lines and anyway I quarreled periodically with the power company over the size of their bill. Not only that, but I would be immune to power failure; it would be FB for emergency operation. So I got a gasoline putt-putt that sometimes refused to putt-putt and that almost asphyxiated the neighbors when it did. And the noise kept the small fry next door awake at nap time. I can now run my generator only between four and four-thirty p.m. on Tuesdays and Thursdays provided the wind is from the southeast. It's hardly enough to keep the batteries up, but since both my neighbors are bigger than I, what else can I do? And besides I won't need as much gasoline.

Like other habits, the surplus one slipped up on me gradually. After the storage battery and generator, I had to round up some assorted plugs and other minor essentials, such as a left-handed, three-wheeled friederstran, which is used only on my transmitter and some electrical equipment made in Patagonia in 1903. In the process of this search, I unearthed a number of real bargains; there was occasionally something I could use in them, and then I saved a lot of money on the stuff. I suppose I have one of the most complete collections of gigantic bargains to be found outside the War Assets Administration's warehouses.

What in the world is wrong with that good old 110 volt 60 cycle power? Wasn't it good enough for the Army and Navy? They seemed to use it only as a last resort. Darned if nearly all the stuff I got didn't run off 28 volts d.c. (they must have driven battleships with it) or sometimes 110 volt, 400 cycle power. I vividly remember the day I tried hooking some 400 cycle equipment to the 60 cycle line. The fuse blew, and after I ran out of fuses, I put a penny in its place. The firemen had things under control in an hour or so and I finished pumping the cellar out next day. This also

**SAVE 50% ON KITS!**

**25 WATT P.P 6L6 Hi Gain AMPLIFIER KIT** **Only \$11.95** **LESS TUBES**

A wonderful buy! Make up an amplifier worth \$50 to you. Powerful enough for auditoriums seating 1500 people. Separately controlled Mikro & Phono inputs. All parts including drilled chassis, hardware, solder, circuit diagram, etc.

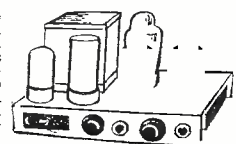

**PHONO OSCILLATOR 2 TUBE KIT . . . \$2.95**  
If you know value, this is it! Orders come from Miami to Miami, Sandy Hook to San Francisco. . . Hi gain with microphone jack and all parts including Tubes.



**FILAMENT TRANSFORMER**  
A top item — bargain priced . . .  
6.3v 8a. . . . .  
115v. 50-60 c pri. . . . .  
700 v. insulation. All \$1.95 ea.



**POWER TRANSFORMER**  
Excellent for AIC/5 or 2TAV. \$87 power supply. 1500v C.T., 150ma, 6.3v 2.5a, 6.3v 1.6a, 5v3a; 115v 50-60c pri. . . . . \$4.89 Ea.



**UNIVERSAL TROUBLE SHOOTER**—Locates every service trouble. Does everything and guaranteed to do everything we say it will. . . Align pointer. Locates dead spots, weak spots, defective parts. Checks gain. All parts including case, test leads, plug, 2 1/4" x 8" x 3" . . . . . \$3.95  
Write for free data, circuits designed by  
**ROBT. G. HERZOG**

**Universal general corp.**  
365 J CANAL STREET N. Y. 13, WA 5-9642

**PRACTICAL TECHNICAL TRAINING FOR YOU**  
**SPECIALIZE In 6 Months to 3 Years**

- COURSES**
- SERVICE**
  - 6 to 12 Months
  - Electricity
  - Welding
  - Refrigeration
  - Heating
  - TECHNICIAN**
  - 1 to 2 Years
  - Electricity
  - Radio
  - Electronics
  - Refrigeration, Heating and Air Conditioning
  - PROFESSIONAL**
  - 3 Years
  - Electrical Engineering
  - Bachelor of Science Degree
  - Major in Machinery or Electronics

Train for a substantial career in industry—or a business of your own. Each 6-month course is complete in itself, yet prepares you for advanced courses. More than 35,000 former students in industries the world over. 1,538 students now enrolled from 48 states and 13 overseas countries. Faculty of 72 specialists. Four terms a year.

Write for booklet "Career Building" and mention course interested in.

**MILWAUKEE SCHOOL OF ENGINEERING**  
A Technical Institute Founded 1903  
RN-948 N. Broadway and E. State, Milwaukee, Wis.

**POCKET RADIO**

**REALLY WORKS TOO!**  
Black Silver Plastic Case. NO TUBES—BATTERIES OR ELECTRIC PLUG-INS! NEEDED! Works by new "Radacrystat" and "Inducto-tune". Easy to use! Should last for years!  
**GUARANTEED TO WORK**  
on local stations by following directions! **ONLY \$3.99 POSTPAID** or send \$1.00 (bill, money order, check) and pay postman \$2.99 plus postage on delivery. **COMPLETELY READY TO PLAY. SWEEP-LETS REALLY LOW PRICED! GET YOUR "POCKET RADIO" TODAY—NOW!**  
**MIDWAY SALES CO., DEPT. PRN-9, KEARNEY, NEB.**



**TELEVISION RECEIVER—\$1.00**

Complete instructions for building your own television receiver. 16 pages—11"x17" of pictures, pictorial diagrams, clarified schematics, 17"x22" complete schematic diagram and chassis layout. Also booklet of alignment instructions, voltage and resistance tables and trouble-shooting hints.—All for \$1.00.  
**CERTIFIED TELEVISION LABORATORIES**  
5507-13th Ave., Brooklyn 19, N. Y.



renewed my feud with the power company who insisted that I had ruined their meter and a transformer for which they collected; but at the same time they refused to pay for that lovely 400 cycle transformer they spoiled for me—and it said 110 volts right on the case too!

Then there was the time I took a surplus receiver down to the broadcast station where I worked. It was a small station, so I had to double as an announcer at times. I had to start a recorded program just as the receiver was ready to test. I turned the receiver volume down to a reasonable level and opened the station microphone for my opening announcement. Precisely at that moment one of those California kilowatts with a 64 element beam aimed squarely at the back of my neck called CQ with a volume only slightly less than that of a bull horn! My car drums are still throbbing and the needle of the db. meter at the station hasn't uncoiled from around the peg yet. The boss says not to worry about it, as I am going to buy a new one for the station. I can just imagine the look on that W6's face though, when he started getting BCI complaints from Texas!

About the same time the golden opportunity came to get that radar set over in the corner of the living room. I worked on some of this gear in the Navy; it was such nice, well-built stuff I couldn't resist the temptation to buy it; I could also show the neighbors what I did in the Navy. Then there was a saving of \$46,759.98 on it. A second mortgage on the house handled part of the financing and I side-stepped the storage problem easily by selling the car so I could use the entire garage as a storeroom. It was about that time, or after walking a few days, that the XYL began to express some slight opposition to radio as a hobby. Once again, we made an additional saving with another new dress, also a big bargain.

I'll skip the financial struggle with the freight bill and the physical struggle to mount the radar antennas on top of the house. I did have to brace the roof considerably and by the time I finished there were so many leaks I had to put on a new roof, which we would have needed in ten or fifteen years anyway. It really didn't look too badly, although the XYL insisted on planting morning glories on it to disguise its appearance.

Two miles of cable, slightly thicker than my wrist, and a few holes in walls and ceiling were needed to hook up the radar set. The holes improved the ventilation, especially in cold weather, and everybody knows fresh air is good for the health. Anyway, we all stood clear as I turned on the set for its first trial. There was a blue flash from the 15,000 volt power supply as Peter the cat lost six or seven of his lives, sprang up almost to the ceiling and ran right through the screen door, spitting fire and brim-

# JUST OUT!

## All the "Know How" of AUTO RADIO REPAIR

in one handy training book . . . for only \$7.50

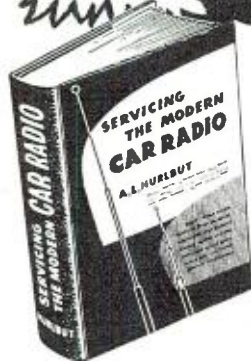

**MAKES THE WORK TWICE AS EASY**

Covers all auto radio types from mid-1930's to the present, including mobile FM receivers

Here—written by a practical auto radio expert of 20 years standing—is just the data you need to repair car radios faster, easier, and a lot more profitably! A. L. Hurlbut's **SERVICING THE MODERN CAR RADIO** is the only book devoted solely to this fast-growing service field. Explains every detail of the work clearly—and tops this off with 222 illustrations and over 500 circuit diagrams covering specific service details on every type of automotive radio in use!

### COMPLETE THEORY—TEST—INSTALLATION—ANTENNA—AND SERVICE DATA

It is the only single book that includes needed data to transform a good home-radio serviceman into a car radio expert. Describes circuits. Explains automotive electrical units, their function and effect on radio performance. Tells how to install car radios properly and why they should be installed that way. Provides circuit diagrams on hundreds of popular models and contains ample data to help you do a good job on sets for which diagrams are not readily available. Gives full details on proper antenna

meaning, contains pertinent information on FM receivers; tells how to get business, how to deal with auto radio service customers, and how to set up your shop, test bench, etc. for maximum efficiency in this specialized, fast-growing field. In short, **SERVICING THE MODERN CAR RADIO** provides at your fingertips a complete, easily understood encyclopedia of facts, methods and data for operating a complete auto radio service station. Use **FREE EXAMINATION** coupon today!

## SERVICING THE MODERN CAR RADIO

BY A. L. HURLBUT

Auto Radio Service Manager and Design Consultant

**Second Edition, 702 pages, 8½ x 11, 222 illustrations, over 500 diagrams, \$7.50**

**Practical, easily understood data on**

Entering the Car Radio Field  
Principal Differences Between Mobile and Home Radios  
Automobile Antennas  
Antenna Input Circuits  
The Power Supply  
Typical Circuit Features  
The Automotive Electrical System  
Setting Up the Car Radio Service Station  
Installing the Car Set  
Installing the Antenna  
Loudspeaker Installation  
Interference  
Servicing Procedure  
Vibrator Maintenance  
Servicing the Loudspeaker  
Car Radio Alignment  
Push-Button Tuning

**and over 500 specific car radio circuit diagrams!**

### OPPORTUNITY OF A LIFETIME

for alert servicemen, says A. A. Ghirardi

Take this advice from A. A. Ghirardi, author of famous radio servicing books and articles!

"I have read Hurlbut's **SERVICING THE MODERN CAR RADIO** from cover to cover. I sincerely believe it represents an opportunity no wide awake serviceman can afford to miss. For nowhere in radio today is there a better chance to build business, increase profits, step ahead of competition!"



Read it 10 Days at our Risk!

### OVER 9,000,000 CAR RADIOS!

"Just think of it! Approximately 16 out of every 100 radio receivers in use today are car radios—and this percentage is increasing every day. Good automotive radio servicemen are scarce—and Mr. Hurlbut gives a gold mine of information you need to cash in on this profitable business!"

## 10 DAYS' FREE EXAMINATION

Murray Hill Books, Inc. (Division of Rinehart & Co.)  
Dept. RN-98, 232 Madison Ave., New York 16, N. Y.

Send me the new Second Edition of Hurlbut's **Servicing the Modern Car Radio** for 10 days' examination on approval. In 10 days I will send \$7.50, plus few cents postage, or return book postpaid. Postage paid on cash orders; same return privilege. (Books sent on approval in U. S. only. Price outside U. S., \$8.00, postpaid.)

Name.....  
Address.....  
City (Zone) & State.....  
Occupation.....

### PEN-OSCIL-LITE

Extremely convenient test oscillator for all radio servicing; alignment • Small as a pen • Self powered • Range from 700 cycles audio to over 600 megacycles u.h.f. • Output from zero to 125 v. • Low in cost • Used by Signal Corps • Write for information.

**GENERAL TEST EQUIPMENT**  
38 Argyle Buffalo 9, N. Y.



### RCA Institutes, Inc.

Offer thorough training courses in all technical phases of Radio and Television

**WEEKLY RATES** **DAYS—EVENINGS**  
**VETERANS!** RCA Institutes is approved under G. I. Bill of Rights  
For Free Catalog write Dept. RN-48  
**RCA INSTITUTES, Inc.**  
A Service of Radio Corporation of America  
350 West 4th St., New York 14, N. Y.

### MEN'S FULLY GUARANTEED NEW 15-JEWEL WRIST WATCH 13.95 PLUS TAX

ORIGINALLY sold up to '55

Sacrificed Because They're POST-WAR Surplus WATERPROOF - SHOCKPROOF

LUMINOUS DIAL • SWEEP SECOND HAND

Anti-magnetic . . . Imported Swiss precision movement and case. You get them now for a small fraction of original prices. Don't delay! Order now . . . while they last. Send only \$1 down payment with order. Pay balance to postman on arrival, plus postage. Or we pay postage if you enclose \$3.95 plus \$1.39 Fed. Tax. Receive Reg. \$2 expansion band FREE with prepaid order. Money back in 5 days if not delighted. Order now.

**MARYLAND DISTRIBUTORS, Dept. 144**  
501 E. Baltimore St. Baltimore 2, Md.





## The Toast of the Trade!

It is rather remarkable how, year after year, so many of the largest and finest radio and electronic manufacturers depend on Quam for their speaker requirements.

This should be of especial significance to the serviceman. For one thing, it

Write for catalog of Quam Adjust-a-Cone Speakers

**QUAM NICHOLS COMPANY**

522 East 33rd Place, Chicago 16, Illinois

QUAM SPEAKERS ARE LISTED IN THE RADIO INDUSTRY RED BOOK

means that these receivers are designed with Quam Speakers as a component part and, when replacements are required, another Quam Speaker should be used to maintain the same high quality of performance.

And it also indicates the confidence these manufacturers place in Quam, and their dependence on the consistently high quality of Quam engineering and production. Take a tip from the people who buy speakers by the thousands, always specify Quam for your replacement job!

stone. The night's papers carried a report of some strange fireball terrorizing our neighborhood. In the meantime, the antennas on the roof started rotating with a dull rumble like distant thunder, gathering speed all the time. There must have been a little vibration from it; I heard a crash in the kitchen as the XYL screamed that all her dishes were falling out of the cabinets. I didn't pay much attention to that, though, as she always stacked the dishes too high anyway. The floor must have been vibrating a little, as the furniture waltzed slowly around the room, there was a dull thud as a large chunk of plaster fell from the living room ceiling, while there was the most gorgeous display of fireworks from the scope tubes and innards of the radar since the Fourth of July. Personally, I think it's a shame they don't make plaster as good as it used to be. Fortunately the fuse blew while I was trying to turn it off without being electrocuted. Two weeks to replaster the house and make other minor repairs, plus a complete spring outfit for the XYL got things back somewhat nearly normal.

One of the local papers heard about the radar set and sent a photographer out to get a story. I showed him the whole set-up, even taking him up on the roof, through the attic and down in the cellar so he could see how it was hooked up. Most of the bugs were out of it by then, so I turned it on to show him how well it worked. At the same time there were several dull explosions in his coat pocket, and a loud cry of dismay. The last time I saw him, he was hunting the nearest fireplug. How was I to know the radar beam would set off those flashbulbs in his pockets that he cracked crawling through the attic? My lawyer saved me several thousand dollars by settling the case out of court, so the total savings to date took another upward spurt.

The XYL started remarking the house was rather crowded, and even fussed about my dropping solder on the living room rug and the holes the battery acid had eaten in it. I told her that proved it wasn't all wool, like the man from the store said, but it didn't seem to help matters any. In desperation, I took some of the crates (the back and front yards were both full of them by now) and built an addition to the garage to get more room for my surplus gear. It was just about finished when some nosey stranger stopped and asked what I was doing, which I explained in detail. How was I to know he was a building inspector, that I was supposed to get a building permit and that I had violated Section 699% of the Building Code? The XYL got me out of jail next day, only after I promised her another new dress.

To make matters worse, a few days later some of the surplus gear I had ordered on the sly came in. The express man would have to deliver it to the XYL while I was at work,

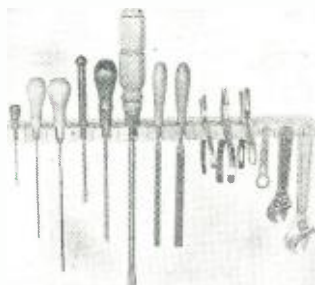

## TOOLRAK SAVES TIME & TOOLS

You always have the right tool at your fingertips when you equip your shop with Toolrak. Because the selected hardwood blocks are interchangeable in the extruded aluminum backstrip, you arrange them any way you want, rearrange as often as you wish. Get Toolrak in factory-assembled sets or buy individual blocks and strips to fit your special needs. Send for free folder.

Set No. 8-7, 8" long, holds 7 tools, \$1.25

Set No. 12-10, 12" long, holds 10 tools, \$1.90

Set No. 18-14, 18" long, holds 14 tools, \$2.55

If your jobber can't supply you, order direct.

Mail orders add 10c per set to cover packing and mailing.

**DAVIS DEVELOPMENT CO.**

348-2 First National Bank Bldg.  
Colorado Springs, Colorado

## BEAUTIFY YOUR TELEVISION SET!

(1) Front Panel, highly polished Bakelite, engraved with your name. Smooth, attractive appearance which rivals most CUSTOM-MADE jobs. 18" High, 17" Wide with cutout for 7" picture tube. 10 days delivery. . . . . Only \$14.75

(2) 3 1/2" Bakelite Dial for controls, switches, etc. . . . . Only \$2.50

(3) Your name engraved in Script on Bakelite Panel. 1" x 3". Included FREE with Front Panel (1), or separately . . . . . Only \$1.00

(4 & 5) Lucite Dials for radios or continuous TV tuners, made to your specifications. For estimate, send sketch with calibrated scale.

(6) Lucite Dial for front panels. Numerals on Station Selector engraved as shown. For different combinations of TV or FM channel numbers or different positioning of titles, send sketch and we will engrave accordingly. Be sure to send paper template for shaft positions. For mounting, remove dial knobs, slide dial over shafts, securing with 4 screws, replace knobs. Size 3" x 20" . . . . . Only \$6.50

In ordering Nos. 1-2-3, specify either of the following colors: Mahogany, Walnut, or Ebony Black, all with white lettering.

All Our products are FULLY GUARANTEED!

Send check or money order. Shipped prepaid U.S.A.

Estimates for commercial and production jobs solicited.

**CUSTOM PLASTICS CO.**

1819 Broadway - - - New York 23, N. Y.

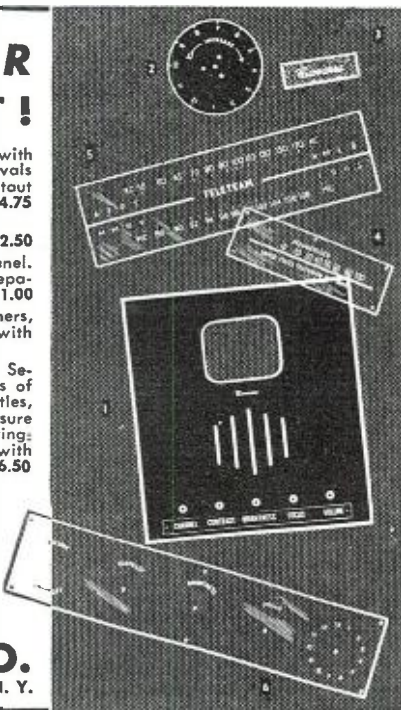

instead of bringing it out on my day off as he had been told to do. Since he was a bachelor, I suppose he didn't understand the importance of such minor details. When I got home, there was a curt note on the table, instead of lunch, that the XYL had gone home to mother with the youngster. I guess she didn't realize how important it was that I have those two transmitters, to fill in that gap from 2466 $\frac{1}{2}$  mc. to 2899 $\frac{1}{2}$  mc. that my other gear doesn't cover. I just had to have complete coverage from 90 kc. to 10,000 mc. in case any of the amateur frequencies were ever changed. That's the trouble with women; they can't see things of that sort in their true perspective.

Lengthy negotiations and a complete new wardrobe for her finally restored peace and the XYL to our household, on certain conditions, which are very irking. If you doubt me, let your wife (if she doesn't already do it) clip all the surplus ads out of your radio magazines and you'll see what I mean. By the time I get them, my magazines look like a player piano roll that has gone through a food chopper.

So far, according to my calculations, I've saved the staggering sum of \$87,-492.36; the XYL was voted the Best Dressed Woman of Pottsville for 1947; and I've taken the pledge—yes, I'm going to join Surplus Anonymous! Say, if you've got a dime, let's get a cup of coffee; I seem to be a little broke this morning.

Did you say you're going to the city next week? Go around to that place on Blank street and see if you can get me a BC738956 and an SCR 3287693 to finish out some of my sets will you? I'll pay you next week, but don't let my XYL catch on.

What's my call? Well, I guess I'll have to confess; I got so interested in my surplus gear that somehow I haven't had much time to work on my ticket, but almost any day now I hope to start my code practice. Of course, that's only a minor detail. Of course, there's a little more surplus I want to try to find first—or could I sell you some of my "surplus" surplus I've got in the garage? —50—



"We want our money back. It puts blisters on Paw ever'time I press his pants!"

September, 1948



## Better Products for the Radio Industry

### NEW G-C STATIC CHASER INJECTOR and POWDER

Tire static powder kits —improve auto radio reception. Eliminates wheel static interference. New powder is blown into all inner tubes—easy to use. For every car owner!

No. 5604 Injector for G-C Static Powder.....List **\$1.50**  
 No. 5605 G-C Static Powder Packet for 5 tires..List **1.00**  
 No. 5606 Kit—One Powder Packet and Injector.....List **2.50**



### G-C FELT-COAT FLOCK FINISH SPRAY KITS

Now it's easy to supply flock for refinishing turntables, cabinets, grilles, etc. Kit contains specially designed spray gun, 2 colors flock, undercoats, thinner, brush, instructions, etc.



No. 180-2.....List **\$9.50**



Have you seen the new G-C "Speedex" Wire Strippers... write for illustrated literature.

RADIO DIVISION, DEPT. H

### NEW G-C TUBE PULLER

Makes it easy to remove or insert miniature tubes... simple to operate. Inserts or extracts tubes where fingers will not reach—into hard-to-reach places.

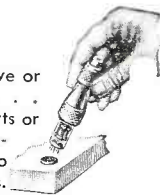

Saves time and money. Ends tube breakage, prevents burnt fingers.

No. 5093 Miniature Puller...List **\$1.65**  
 No. 5093D Display of 12...List **19.80**

### G-C "Speedex" WIRE STRIPPER

Strips insulation from wire sizes No. 8 to No. 30. Ideal tool for manufacturers, electricians, maintenance men, etc. Strips 750 to 1000 wires per hour.



For the new 300 ohm Television and FM twin transmission line:

No. 733-H Standard Model. List **\$6.00**

No. 744-H Automatic Model. List **8.00**

G-C Products are available at leading distributors. Write for your copy of our new illustrated catalog.

**GENERAL CEMENT Mfg. Co., Rockford, Ill., U. S. A.**

Manufacturers of over 3,000 products • Sales offices in principal cities

For added sales  
(and profits!)



**demonstrate**

the amazing Shockproof

**nylon needle\***

by

**DUOTONE**

Actually b-o-u-n-c-e the whole tone arm on a record without effect. A spring steel shaft and nylon elbow—that is the secret!

**\$2.50**  
LIST

\*pat pending



## Industrial Teleceivers

For Public Viewing in

TAVERNS - HOTELS

INSTITUTIONS

SCHOOLS

CLUBS

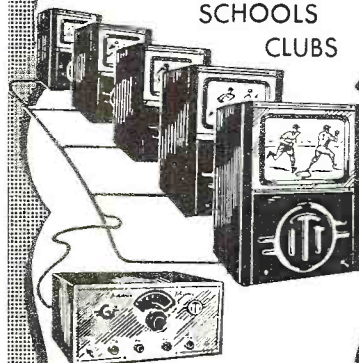

Featuring—  
SIMPLIFIED  
CENTRAL CONTROL  
with any number of  
viewing screens



**INDUSTRIAL  
TELEVISION, INC.**

359 LEXINGTON AVE., CLIFTON, N. J. GREGORY 3-0900

**YOU DON'T NEED MONEY TO BUY FROM**



**HERE'S ALL YOU DO:**

1. Send a list of my items you want.
2. Send a list of your equipment that you no longer need.

**THEN—I'LL AIRMAIL YOU MY OFFER.**

Here's a chance to cash in your unwanted equipment for something you really need:

**ERECO BEAM ROTATOR**

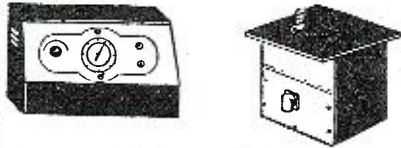

Features:—110 volt 60 cycle—variable speed—4 tone crackle console—selsyn indication—supports 250 lb. beam—weatherproofed—90 day guarantee. Hundreds in use. Dealers' inquiries invited.

**\$69<sup>95</sup>**

Net f.o.b. Everett.....

**STILL IN STOCK**

As advertised and illustrated in Radio News (refer to issue indicated).

- 1 watt neon NE-30 (May).....**\$0.14**
- ¼ watt neon bulb NE-48 (June)....**.08**
- 1" clear pilot light w/NE-48 (June)..**.19**
- 28V. frosted bulb 2-21CP DC bayonet (June).....**.05**
- 12-16V clear bulb 15CP cand. base (June).....**.05**
- Relay 10,000 ohm plate operated (April).....**.49**
- 3 conductor telephone cord (May)....**.09**
- 45' coil antenna wire (May).....**.19**
- Impedance adapter MC-385-B (May)....**.19**
- Transformer 10,000 V. 23MA. 115 V. 60 cy. (June).....**6.95**
- Selsyns #2J (July).....**.69**
- D C Selsyn system complete (June)....**4.49**
- PE-103A Plug (April).....**.69**
- PL-64 plug for 8C-375 (May).....**.49**
- VHF Tank Circuit (May).....**.29**
- Mica trimmers 10-140 & 10-180 mmfd. (April-May).....**.05**
- Bathub condenser .3 mfd. 400VDCW (April).....**.05**
- Antenna Insulator 12" long, 1" dia. (July).....**.10**

**AMPLIDYNE**

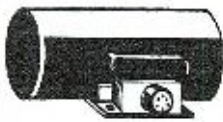

Amplidyne. GE#5AM-31N19A. 530 Watt 28VDC input 60-0-60 VDC output at 8.8A.

Brand New.....**\$295** ea.

**CHAFF DISPENSER**



Radar Chaff Dispenser. Complete with control box, 5 position selector switch, pilot

light, micro-switch, 2 /20HP 27V. 5000 RPM 4 wire motors, 50 meshing gears and 2 M&F sets 7 prong amphenol connectors. Brand New. each.....**\$295**

Enclose postage. Satisfaction guaranteed or your money back. Hundreds of bargains in our free illustrated list.

**DICK ROSE ERECO**  
2912 Hewitt Ave. Everett 20, Wash.

**TV Power Supplies**

(Continued from page 56)

Improved voltage regulation, as indicated by the characteristic voltage-current curves shown in Figs. 8, 9 and 10, is obtained when the capacitances recommended on Figs. 2-6 are used. The improved regulation is obtained as a result of the fact that selenium rectifiers can withstand heavy momentary overloads. Consequently large condensers can be used for filtering with a resultant improvement in regulation. However, if the regulation indicated exceeds requirements for any one or series of circuits, lower valued condensers can be employed. This may be preferable from an economy viewpoint. The engineer should consult the condenser manufacturer for the optimum type of condenser to use in any individual circuit.

The 5 or 22 ohm resistor in series

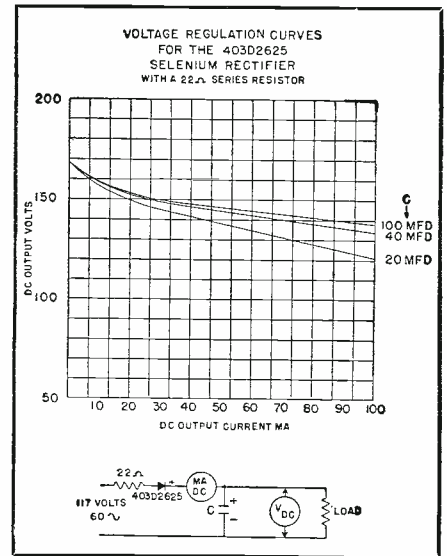
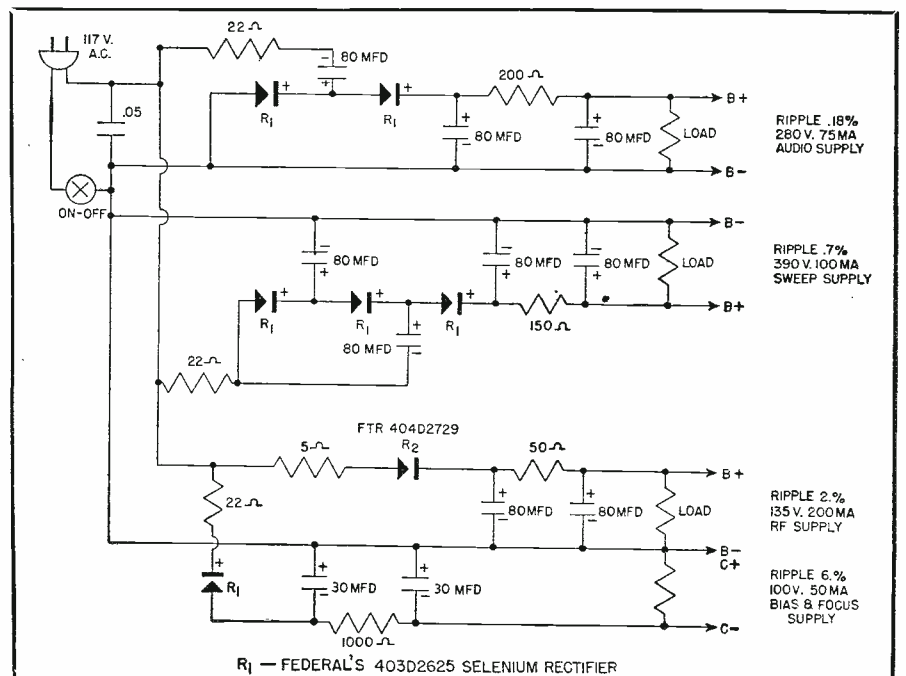

Fig. 8. Characteristic voltage-current curves for a half-wave, selenium rectifier circuit.

INPUT A. C.		OUTPUT D. C.				RIPPLE VOLTS		CAPACITANCE
E	I (Amps.)	E <sub>1</sub>	I <sub>1</sub> (Ma.)	E <sub>2</sub>	I <sub>2</sub> (Ma.)	E <sub>1</sub>	E <sub>2</sub>	μfd.
323	.540	200	100	400	200	4.5	9.2	40
323	.43	203	75	402	150	3.4	7.1	
323	.30	205	50	410	100	2.35	4.8	
323	.16	210	25	416	50	1.22	2.5	
323	.0055	219	0	469	0	.37	.22	
323	.54	200	100	400	200	3.0	6.2	60
323	.43	204	75	402	150	2.2	4.9	
323	.30	206	50	410	100	1.55	3.25	
323	.16	210	25	416	50	.83	1.7	
323	.0055	219	0	469	0	.27	.15	
323	.54	200	100	400	200	2.2	4.7	80
323	.43	204	75	401	150	1.7	3.6	
323	.43	206	50	410	100	1.13	2.4	
323	.16	210	25	416	50	.64	1.25	
323	.0055	219	0	469	0	.20	.11	

Table 1. Voltage regulation characteristics of vibrator power supplies using Federal No. 404D2795 miniature selenium rectifiers.

Fig. 7. Schematic diagram of a multiple power supply which provides separate output for each functional stage in a television receiver.



R<sub>1</sub> — FEDERAL'S 403D2625 SELENIUM RECTIFIER

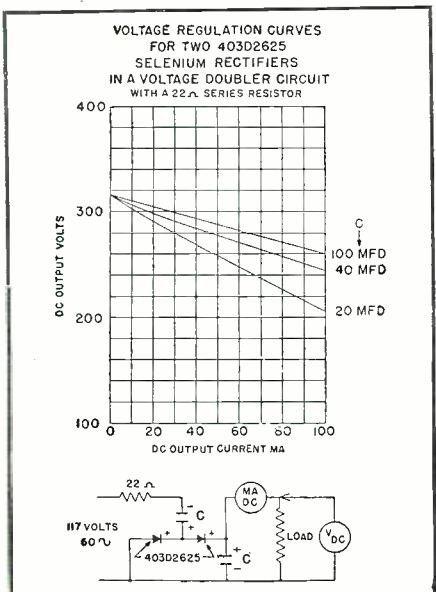

Fig. 9. Characteristic voltage-current curves of a half-wave, voltage doubler circuit using the selenium rectifiers.

with each supply functions both as a current limiter and fuse. This resistor should be of the blow-out type so that in the event of a short circuit, the resistor will burn out before the rectifier is damaged.

Miniature selenium rectifiers have already been widely accepted by the radio industry where they are used as standard components for home broadcast and television receivers and mobile communications equipment. Life tests run in the *Federal* laboratories indicate that it is reasonable to expect that a large percentage of the rectifiers utilized will outlive the television or radio set when properly installed.

It is recommended that, whenever possible, the selenium rectifiers be installed in the coolest position on the chassis.

Fig. 10. Characteristic voltage-current curves of a half-wave, voltage tripler circuit using the selenium rectifiers.

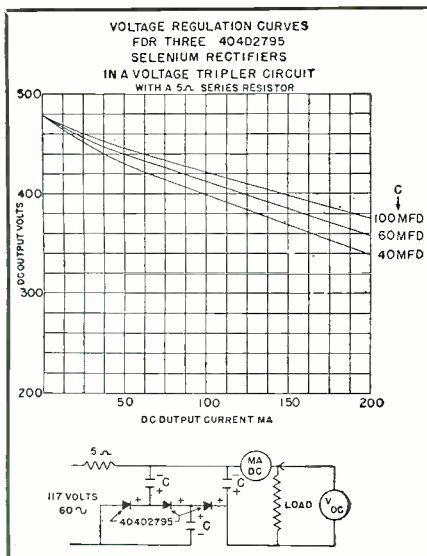

Proved in Millions  
of Applications!

WARD LEONARD

RELAYS  
RESISTORS  
RHEOSTATS

Vast Variety of Stock Units  
ANSWERS EVERYDAY NEEDS ECONOMICALLY

Relays are available from stock in general-purpose, industrial, and radio amateur types for continuous or intermittent duty.

Vitrohm wire-wound Fixed Resistors are available in 8 stock sizes from 5 to 200 watts. Adjustohms in 7 stock sizes from 10 to 200 watts. Plaque Resistors in 3 sizes from 20 to 125 watts. Discohms in 18 watts. Stripohm in 5 stock sizes from 30 watts to 75 watts. Ring-type close control Rheostats in 4 stock sizes from 25 to 150 watts. (Plate Type Rheostats recommended for larger sizes.) Wide variety of Resistance Values.

AUTHORIZED DISTRIBUTORS EVERYWHERE  
**WARD LEONARD ELECTRIC COMPANY**  
Radio & Electronic Distributor Division  
West Jackson Blvd., Chicago 4, U. S. A.

SEND FOR HELPFUL CATALOGS  
*Catalog D-130* gives complete data and listings on stock units available in Resistors, Rheostats and Radio Amateur Relays. *Catalog D-20* lists Industrial and General-Purpose Relays. Write for them today!



**WARD LEONARD**  
Basic 3R's in Current Control

**FREE RADIO CATALOG**  
Limited to Calif., Oregon, Wash., Idaho, Montana, Utah, Wyoming, Nevada.  
Useful buying guide and reference  
**ZACK RADIO SUPPLY CO.**  
Department 38  
1426 Market St., San Francisco 3, Calif.

32  
FACT-  
PACKED  
PAGES

Elements of **MAGNETIC**  
**TAPE RECORDING** and  
999 Applications  
by **A. C. SHANEY**

Only 25c **AMPLIFIER CORP. of AMERICA**  
398-2 BROADWAY, NEW YORK 13, N. Y.

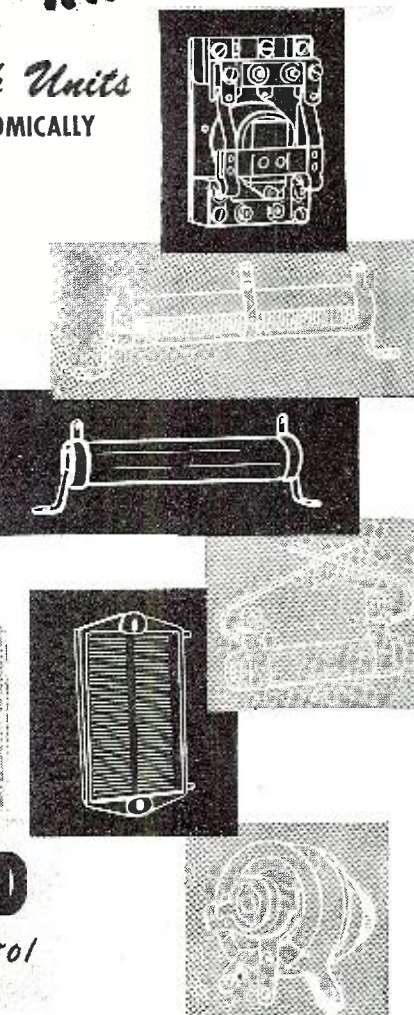

**RADIO ENGINEERING  
TELEVISION  
ELECTRONICS**

Thorough training in all phases of radio and electronics, open to high school and junior college graduates. Old established school specializing in Radio training exclusively. Modern laboratories and courses. Enrollments limited. Approved veteran training.

**VALPARAISO TECHNICAL INSTITUTE**  
Dept. RD Valparaiso, Ind.

# The BAND-IT Clamp

FOR TELEVISION MASTS,  
F. M., AND AMATEURS

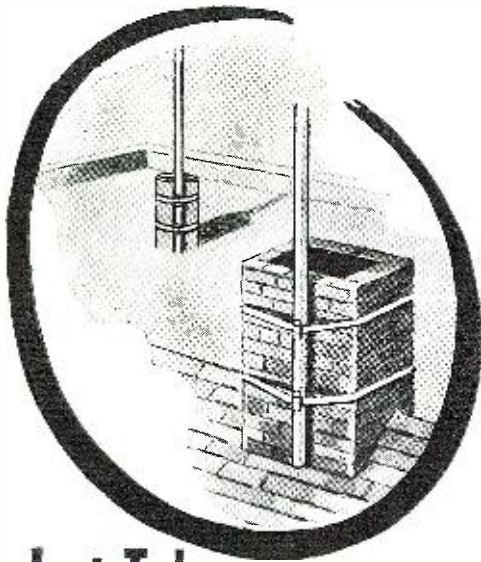

## Just Take BAND-IT to the Job!

**WILL MOUNT TELEVISION MASTS  
TO ANYTHING REGARDLESS OF  
SIZE OR SHAPE**

Television Service Men prefer *Stainless Steel* BAND-IT for erecting television masts. BAND-IT *Stainless Steel* Band in 100-foot rolls and *Stainless Steel* Buckles enable you to band masts to anything.  $\frac{3}{4}$ " width is recommended. You make the correct size bands right on the job.

With *Stainless Steel* BAND-IT Clamps there is no rusting—no tedious drilling—no expensive fittings—no guy wires—no nails to drive. Your labor cost, is kept at a minimum. All Clamps are installed by the simple, completely portable BAND-IT Tool with tension as high as 2000 lbs. for each *Stainless Steel* Band. Installation costs a few cents—can be made in a few seconds.

**• BAND-IT Clamps Are  
Recommended by All Major  
Manufacturers of Television**



## BAND-IT CLAMPS

**BAND-IT** Company, Inc.  
2536 Walnut Street  
Denver 5, Colorado

The Leading Electronics Supply House  
in Your City Is A BAND-IT Distributor



# AFCA NEWS

### AFCA Chapter Notes

#### Problems to Chapters

Mr. Fred R. Lack, General Chairman of AFCA Advisory Committee, has distributed several problems sent to AFCA by the Armed Forces for study to selected chapters, whose reports will be sent to Mr. Lack for coordination with his own studies.

#### Atlanta

A dinner meeting was held on June 8th at the Naval Air Station. Capt. E. T. Neale, Commanding Officer of the Naval Air Station, was host at the dinner. Among those present were General A. C. Gillem, Commanding General of the Third Army, and Colonel R. C. Paul, Commanding Officer of the Air Base at Marietta. The principal speaker was Major General W. O. Reeder, Deputy Director of Logistics, whose topic was "Signal Trends and the Part Industry Must Play in Assisting the Armed Forces."

The Atlanta Chapter has initiated an award which it will present annually to the Army or Air Force ROTC student or NROTC student in the communications course at the Georgia School of Technology. This year's award (an embossed slide rule) was won by Cadet 1st Sergeant John C. Gall, ROTC.

#### Baltimore

Chapter members met on June 8th in the auditorium of the Enoch Pratt Library to hear Mr. E. K. Jett, Vice President and Director of the *Baltimore Sunpapers*, and National Vice President of AFCA, speak on "Telecommunications—International and Domestic."

The newly elected President of the Chapter is Mr. Frederick E. Moran, Superintendent of the *Western Union Telegraph Company* in Baltimore.

#### New York

Officers, directors and committee chairmen of the New York Chapter met on June 29th at Cavanaugh's Restaurant in New York. They discussed ways and means of making the chapter larger and better able to assist in carrying out the missions of the Association.

#### Washington

The Washington Chapter officers and committee chairmen met on July 15th at the Raleigh Hotel to plan a program of interesting meetings beginning in September. It was proposed that some of these meetings be held jointly with the local chapters of IRE, ARRL and AIEE. The National Executive Secretary, General S. H. Sherrill, informed those present of the Navy's decision to sponsor next year's annual meeting, probably with Washington as the location.

-30-

### WAR SURPLUS BARGAIN SPECIAL!

Brand New  
BEAM ANTENNA  
ROTATOR  
MOTOR

**\$5.95**

Postpaid in  
Continental U.S.A.

- OPERATES DIRECTLY ON 110V AC, 60 CYCLES (Requires only 12 MFD Condenser)
  - NO STEP-DOWN TRANS. NEEDED
  - NO LINE RESISTOR NEEDED
  - HIGH TORQUE — NO FREE SWING
  - APPROX.  $\frac{3}{4}$  R.P.M.
  - REVERSIBLE — ONLY THREE WIRES NEEDED
  - ELECTRICALLY & MECHANICALLY QUIET
  - LIGHTWEIGHT, RUGGED, QUIET
  - MOTOR & GEARS OIL SEALED
  - NO EXPENSIVE CONVERSIONS
  - FLAT MOUNTING SURFACE — FOUR TAPPED HOLES
  - FB. FOR 2-6-10-LITE 20 BEAMS
  - FREE COMPLETE INSTRUCTIONS & DIAGRAMS
- ALVARADIO SUPPLY CO.**  
Dept. RN-9, 903 So. Alvarado, Los Angeles 6, California



## TELEVISION ELECTRONICS

LEARN RADIO THE  
NORTHWESTERN WAY

- BASIC RADIO
- RADIO SERVICE
- COMMUNICATIONS
- INDUSTRIAL ELECTRONICS
- TELEVISION

Highly Trained Instructors  
Modern Equipment  
Spacious Building and Grounds

NORTHWESTERN VOCATIONAL INST.



745 Grand Ave.

ST. PAUL 5  
MINN.

## 12B8 and 25B8 Tubes

Adapter unit using 2 miniature tubes (6AT6 and 6BA6) or (12BA6 and 12AT6). Takes less space than original tube—nothing else to buy—just plug in and it works. Money-back guarantee. 12B8 or 25B8 unit complete: \$2.49 each. 10 units for \$22.50.

Send 25% deposit, balance C.O.D. Write for free parts catalog.

## COMMERCIAL RADIO

36 Brattle Street, Boston 8, Massachusetts

## LEARN RADIO!

IN ONLY 10 MONTHS  
**PREPARE FOR A GOOD JOB!**  
COMMERCIAL OPERATOR (CODE)  
BROADCAST ENGINEER  
RADIO SERVICEMAN

Television Servicing—15 Months

Veterans get \$130.00 Equipment  
SEND FOR FREE LITERATURE  
**BALTIMORE TECHNICAL INSTITUTE**  
1425 EUTAW PL., DEPT. R, BALTO. 17, MD.

## Gain Measuring Unit

(Continued from page 63)

multiplier is set. It also permits the construction of a straight line correction chart. 5000 ohms is the resistance of most db. meters and has been used quite universally, however, only infinity would be perfection. Details on the multiplier are shown in Fig. 8. Caution should be exercised in isolating or shielding any high level audio from any part of the low level audio circuit as feedback might occur here when high gain amplifiers are being tested.

Jacks are connected across the db. meter for an oscilloscope. If a scope is available it should be used. The output signal waveform on a good amplifier will be the same as the input signal. This comparison can be made quickly and easily by throwing the meter switch between "INPUT" and "OUTPUT." If a little care is taken in the adjustment of the "OUTPUT MULTIPLIER" and "AUDIO INPUT GAIN" so both read about the same place on the db. meter, the picture on the scope will be nearly the same size for both input and output signals, thus eliminating any readjustment of the gain control on the scope.

In testing amplifiers it is often desirable to know the watts output. Before taking any reading be sure the output is properly loaded. Connect the db. meter with the multiplier set well beyond any possible output. Turn the multiplier back until the db. meter can be read easily. Add algebraically

Fig. 8. 5000 ohm. constant-impedance power level indicator multipliers. Accuracy of about 2% should be the goal.

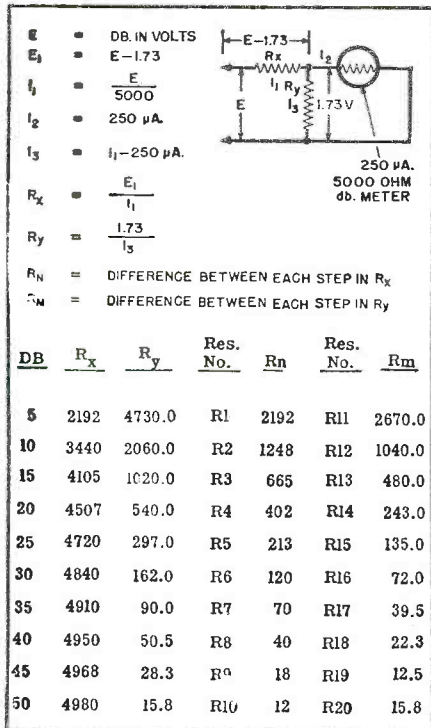



# NOW! BUILD 15 RADIOS

COMPLETE KIT ONLY... \$14<sup>75</sup>

ABSOLUTELY NO KNOWLEDGE OF RADIO NECESSARY  
YOU NEED NO ADDITIONAL PARTS!

THE PROGRESSIVE RADIO KIT is the ONLY COMPLETE KIT

Operates on 110-120 volts AC/DC. Contains everything you need. Instruction Book, Metal Chassis, Tubes, Condensers, Resistors and all other necessary radio parts. The 36-page Instruction Book written by expert radio instructors and engineers teaches you to build radios in a professional manner. The first circuit built is a simple one-tube detector receiver. Each succeeding circuit incorporates new arrangements of detectors. RF and AF amplifiers. This kit is excellent for learning the principles of receiver, transmitter and amplifier design. It is used in many radio schools and colleges. All of the commonly-used detectors are used, including diode, grid leak, plate and infinite-impedance. The transmitters are designed with Hartley and Armstrong oscillators, using screen-grid and control-grid modulation. Both vacuum tube and selenium rectification are employed in these circuits. The circuits are

designed to provide excellent performance. Altogether, fifteen circuits are constructed, including 11 receivers, 1 audio amplifier, and 3 transmitters. The sets start with simple circuits of 1 tube plus rectifier, gradually grow more complex, and finish with several examples of radio sets using three tubes plus rectifier.

**PROGRESSIVE RADIO KIT, ONLY \$14.75**

### SPECIAL FREE OFFER

Electrical and Radio Tester sent absolutely FREE with each Progressive Radio Kit. PLUS FREE membership in Progressive Radio Club. Entitles you to free expert advice and consultation service with licensed radio technicians. Write for further information or ORDER your KIT NOW!

WE PAY POSTAGE ON PREPAID ORDERS

C. O. D. ORDERS SHIPPED COLLECT

## ATTENTION RADIOMEN!!

Progressive's new DEALER'S CATALOGUE is just off the press.

- RADIO KITS
- AMPLIFIER KITS
- FM COIL & CONDENSER KITS
- RESISTOR KITS
- CONDENSER KITS
- RADIO TOOL KITS
- FM-AM CHASSIS
- SPEAKERS
- RADIO PARTS
- PORTABLE RADIOS
- CAMERA-RADIOS
- TUBES
- AUTO RADIOS
- HOME RADIOS
- TELEVISION SETS
- TELEVISION CABINETS
- TEST EQUIPMENT
- FM TUNERS

SEND FOR YOUR FREE DEALER'S CATALOG AND PRICE LIST TODAY!

## PROGRESSIVE ELECTRONICS CO.

Dept. RN-13

497 Union Ave.

Brooklyn 11, N. Y.

### RADIO ENGINEERING!

DEGREE IN 27 MONTHS

COMPLETE Radio Engineering Course. Bachelor of Science Degree. Courses also in Civil, Electrical, Mechanical, Chemical, Aeronautical Engineering, Business Administration, Accounting, Secretarial Science. Graduates successful. 65th year. Enter Sept., Jan., March, June. Write for catalog.

**TRI-STATE COLLEGE** 1698 College Ave. Angola, Indiana



**SHORT CUT** **CODE SPEED**

Learn to be a Telegraph or Radio Operator. Thousands of men needed. Intensely interesting work — good pay. Learn at home or wherever you are, quickly, easily, with the famous Candler Code Speed System. Quality for Amateur or Commercial License. Book of particulars Free.

**FREE BOOK**

CANDLER SYSTEM CO. Dept. 2-R, Box 928 Denver 1, Colo.

**HERE IT IS! - - - -**  
A Portable A.C. Amplifier for only \$21.50 (List \$64.50)

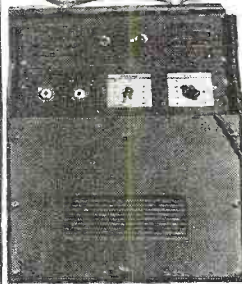

A real professional type HIGH FIDELITY unit (lic. by W.E.) at an AMAZINGLY LOW PRICE. WIDE FREQUENCY RESPONSE for use with: MUSICAL INSTRUMENTS, SPEECH or PHONO INPUT, FM TUNERS, etc. 110V. 60 cycles. Features: 8" Alnico I'M speaker; 2 inputs (magnetic or crystal); vol. & tone controls; Beam Power Output. Beautiful, sturdy 2-tone brown leatherette case (13 3/4" x 15 3/4" x 7 1/2"). Shpg. wt. 12 lbs.

**\$21.50**  
WHILE THEY LAST.....  
In lots of 3..... \$17.95  
20% DEPOSIT REQUIRED ON C.O.D.'s  
**LEOTONE RADIO CO.**  
65 DEY ST., NEW YORK 7, N. Y.

# FALL SPECIALS

## TUBE SPECIALS

GUARANTEED—STANDARD BRAND

1LH4	.59	12A6	\$.30
1LN5	.59	12SA7GT	.45
3B7	.89	12SG7	.62
3D6	.69	12SK7GT	.40
3S4	.49	12SH7	.65
3Q4	.59	12SQ7	.50
5R4GY	.89	25L6GT	.50
5U4G	.45	50L6GT	.50
6AB7	.89	117Z6	.80
6AC7	.59	30	.60
6AG7	.79	34	.89
6D6	.40	45	.80
6J5	.39	76	.45
6L6	.70	956	.65
6S17	.39	958-A	.60
6SK7	.40	959	.45
6SL7	.40	1625	.35
6SN7	.40	20A7	.69
6V6 GT/G	.45	803	6.00
6X5GT/G	.45	807	.95

## SWITCHES

SPST AN-3022-2B Bat Handle, Lum. Tip	\$.25
SPDT AN-3022-6B Inside Mom. Center off. Lum. Tip	.25
DPDT Slide Sw. Stackpole 5 A. 125V.	.15
SPDT Momentary, center off. 6A 125V Long Bat Handle	.30
4PDT Bat Handle 10A 125V	.50
SPDT Center off. AN-3022-1B Lum. Tip, 6A 125V	.30
SPST Bat Handle, 6A 125V	.25
SPDT Bat Handle, 6A 125V	.30
DPDT Momentary, center off. 10A 125V	.50
DPST AN-3023-2, 10 A 125V	.45
DPST Momentary, Push Type, 6A 125V	.35
SPST Rotary (enclosed) 6A 125V, 1/2" Shaft	.25
SPST Phono Switch, 1/2" Shaft	.20

## G. E. SWITCHETTES

CR-1070C103-B3 normally open	\$.35
CR1070123-C3 normally open or norm. closed	.35
CR-1070C103-K2 normally closed	.35

## SURPLUS SPECIALS

Small 110V AC 60 cycles open frame motor 1/2" shaft, 2700 RPM, 1/70 HP mfg. by Barber Colmann Co.	\$2.00
Synchronous Motors 1/2" shaft 110V AC 60 cycle, 4/5, 1, 1 1/2 & 1 1/2 RPM 2.2 Watts, mfg. by Hayden Mfg. Co.	2.00

(Specify speed desired)

## AMAZING BLACK LIGHT

Complete with resistance line cord and Ultra Violet ray filter. Ready to use from 110V AC line.	
Rigid Mount Type	\$3.95
Gooseneck Mount Type	4.49
Replacement Bulbs	.35

Luminous Paint kit consisting of two colors, Blue and Violet. Can be used in conjunction with Black Light.	\$0.89
--	--------

## MISCELLANEOUS

PL-259A Coax Connector & Socket silver plated, for RG8U & RG11U. Pair	\$0.60
Variable capacitors: 4-30 muf 7-45 mmf.	.25
Telescoping Antenna, 7 foot.	1.00
Rectifier, Copper oxide, full wave 110V AC input, 100VDC output 1 A.	3.50
Solenoid, 6 V DC complete with plunger and mtg. bracket	1.25
Pilot Light Assy. complete with 1/2" jewel, white or red, & 6V bayonet socket.	.25
Flexible Shaft 8 1/4" long with spline ends.	.25
PL-55 Phone plug with 4' cord.	.30
DI-Heptal sockets (less mtg. ring)	.50
2X2 socket	.35
Octal Steatite socket	.15
4 Prong socket	.12
Shock Mounts (Lord) cap. 75 lbs.	.60
Stepdown Transformer UTC Type 63823 220V to 110V, 100 Watts, 60 cycles.	4.00
Octal plug	.20
Dynamic Microphone ELECTRO VOICE Model 600 C (press to talk switch) cord & plug High Impedance.	4.50
T-17 Microphone with press to talk switch, cord & plug.	.79

## WIRE WOUND RHEOSTATS

1.1 ohm 50 Watt with switch	\$1.25
6 ohm 25 Watt	.65
8 ohm 50 Watt	1.00
250 ohm 50 Watt	1.00
2500 ohm 25 Watt	.65

## CONDENSERS & CAPACITORS Standard Brands

Capacitor 500 mfd. 200 V DC	\$1.75
4 mfd. 2000 V DC Oil Filled Cond.	3.75
10 mfd. 1500 V DC Oil Filled Cond.	2.95
10 mfd. 600 V DC Oil Filled Cond.	.90
1 mfd. 2500 V DC Oil Filled Cond.	1.25

No sale less than \$2.00. All prices F.O.B. N.Y.C. Add 25c to cover postage. 20% deposit required with all orders.

## A. M. RADIO SALES CO.

345 Canal St. New York City 13, N. Y.

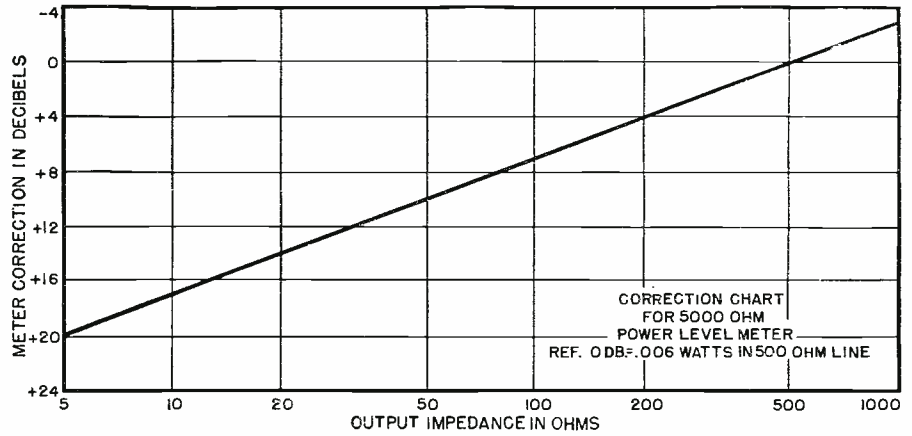

Fig. 9. Output impedance in ohms vs. meter correction in decibels. Add correction to output reading to find correct power level for the line impedance used. Refer to Fig. 10, below, to find the power output in watts.

the deviation from 0 on the db. meter, to the setting of the multiplier. See the chart db. vs. watts (Fig. 10), if the output impedance is 500 ohms, if not, see chart giving correction for 5000 ohms power level meter (Fig. 9). Example: Assume an amplifier with a 15 ohm output. Put a 15 ohm resistor of suitable wattage across it for a load. The db. meter reads +1 db. with the output multiplier on +10. Add +1 and +10 and we have +11 db. Upon checking the chart of Fig. 9, it will be found that 15 ohms calls for a correction of approximately 15.2 db. +15.2+11 equals +26.2 db. Referring to the chart of Fig. 10 the output is 2.5 watts.

It would be better to have the multiplier connected directly to the output for making frequency response checks as the impedance of a condenser goes up as the frequency goes down. Even with a 2  $\mu$ fd. coupling condenser with only 80 ohms resistance at 1000 cycles, it has 1000 ohms resistance at 80 cycles which means a 20% error at 80 cycles. The condenser was used as a precaution against any direct current getting on the meter so it has been incorporated in the unit. This situation can be bettered by using a higher resistance meter, or a larger condenser, or a transformer, or another jack which would be connected directly to the

multiplier, thus providing a choice of direct, or condenser coupling. When making frequency response runs the unit is usually connected through an output transformer, so direct coupling can be used. This will save both space and cost.

The attenuator is used for fine adjustment or fading from the reference level. It might be desired to adjust the "SIGNAL OUTPUT" to a value that the "REFERENCE LEVEL" and "ATTENUATOR" will not make. This is easily done by adding or subtracting the required amount on the db. meter. The attenuator should be of the bridged "T" or "H" type, with "zero" insertion loss. The amount of change per step can be of the designer's choice. 1/2, 1, 1 1/2, 2, 2 1/2 and 3 db. per step units are made by various manufacturers. Of course, the price, physical dimensions, accuracy, and type are all contributing factors which can be decided upon best by the builder of the Gain Measuring Set. Some types have to be made to order so this means a waiting period. Since it is desirable to read within 1 db., but it is seldom necessary to read increments any smaller, a Daven type T 324 F 1 db. per step attenuator was chosen for this Gain Measuring Set. If the attenuator has an insertion loss, it must be taken into consideration whenever measurements are taken.

Fig. 10. Power in watts vs. output reading in decibels.

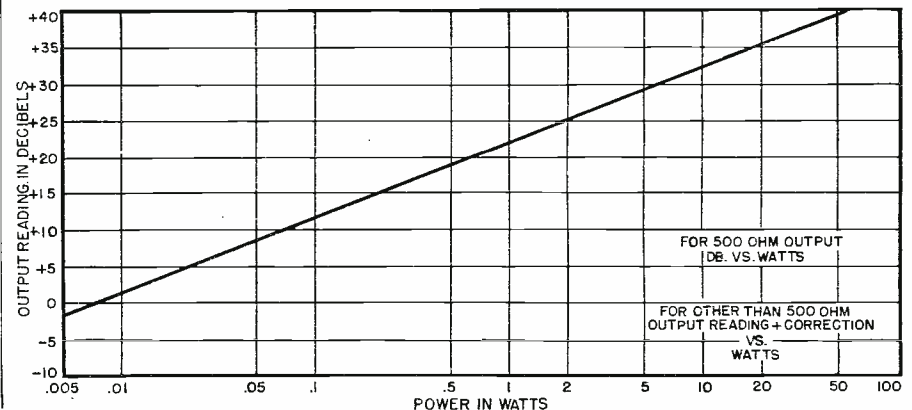



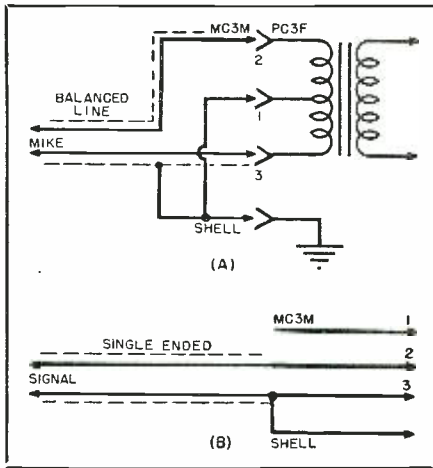

Fig. 11. By connecting the center tap of the input transformer to the number 1 pin, it can be grounded through the shell to the chassis for a balanced line, (A), or not used at all when working single-ended (B). This arrangement allows the use of a single-ended gain measuring set or any other single-ended gimmick into a balanced line input without tearing into the amplifier to disconnect the center tap. Ground connection shown is made to chassis. Amphenol MC3M and PC3F adapters were used in this application.

This is a nuisance and can be corrected by inserting a 5000 ohm "L" pad between the +10 db. "INPUT REFERENCE LEVEL" switch and the "DB. METER" switch, with a loss the same as the insertion loss. Naturally the insertion loss must remain the same additional amount to the db. loss shown on the attenuator for any point selected. The explanation for this is that the level of the audio oscillator input must be raised the same amount to overcome the 5000 ohm "L" pad as is lost through insertion, so the audio oscillator must be capable of generating this extra amount. To compute the value of the "L" pad see Fig. 8.

A block diagram of the Gain Measuring Set in use is shown in Fig. 4. On a good many test benches this setup will be used so frequently that it will be left hooked up and ready at all times.

The Gain Measuring Set illustrated answers almost every need that the builder has for such an instrument. Perhaps only a portion of this instrument would answer your needs and those circuits could be built into your audio oscillator. Naturally there can be more elaborate setups, but this article is intended to point up an angle of which very few servicemen or experimenters are aware. Playing phonograph records or saying "1, 2, 3, 4 testing," may be all right for testing pickups and mikes, but power equipment should be capable of being checked more scientifically. Even if the output checks good, there is no way of knowing whether the amplifier has the proper gain unless the value of the input signal is known. Any substantial loss in gain will usually result in a lack of driving power for the final output unless the mike or pick-

Calling all  
Police cars

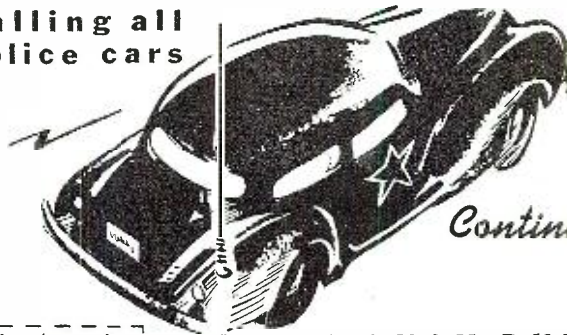

24 HOURS

Continuous Operation

CALLS FOR

## JAMES PUSH-PULL VIBRATOR

The Vibrator Which Definitely Outperforms

OUTSTANDING FEATURES:

1. Frame cooled reeds (no stack to compress).
2. Push pull driving system (driving power squared).
3. Angular positioned reed arms.
4. Thick reed (.010 inch) and power to drive it.
5. Fully adjustable . . . every vibrator identical.
6. Proper reed stress distribution.
7. Large stationary arm heat dissipation area.

Complete Information and Replace Guide Available . . .  
See Your Parts Distributor . . . Or Write

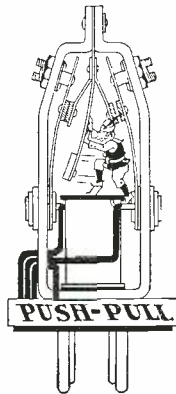

JAMES VIBRAPOWR CO.

3224 W. Armitage Ave.

Chicago 47, Illinois

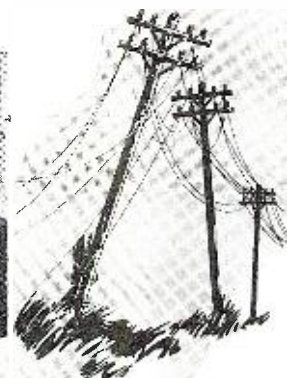

Guard Against Costly Power Failures with

## ONAN STANDBY ELECTRIC PLANTS

When storms, floods or breakdowns interrupt electric service to your station and force you off the air, you lose listeners . . . you lose income . . . you lose the opportunity to give vital service to your community. These losses can be prevented by installing a dependable Onan Standby Electric Plant.

Always on guard against commercial power failures, Onan Plants equipped with Line Transfer Controls *automatically* take over the job of supplying electricity during emergencies. Upkeep costs are negligible. Only periodic servicing and inspection are required.

Range—1000 to 35,000 Watts A.C.

**D. W. ONAN & SONS, INC.**

4794 Royalstone Ave.

Minneapolis 5, Minn



Write for  
Catalog



# ONAN STANDBY POWER



## WUXTRY! GET THE XL-347!

### THE CONNECTORS WITH TECHNICAL SUPERIORITY...

favorite of sound technicians in night clubs, radio stations, motion picture studios—and also used extensively by “hams”. Cannon Connectors require



XL-3-12 PLUG  
LIST \$1.20

XL-3-11 PLUG  
LIST \$1.25

a minimum of servicing—that's why sound men prefer Cannon.

Latch-lock keeps plug *positively* connected—no scratchy connections with loose coupling nuts. It stays connected!

Available from more than 300 distributors: In NEW YORK, Harvey and Newark Radio. In CHICAGO, Allied, Newark and Walker-Jimieson.

We'll send the XL-347 and the RJC-2 for the asking. Address Department I-228.

SINCE 1915

**CANNON**  
**ELECTRIC**

*Development Company*

3209 HUMBOLDT ST., LOS ANGELES 31, CALIF.

IN CANADA & BRITISH EMPIRE:  
CANNON ELECTRIC CO., LTD., TORONTO 13, ONT.

WORLD EXPORT (Excepting British Empire):  
FRAZAR & HANSEN, 301 CLAY ST., SAN FRANCISCO

up could make up this loss. Where a great number of a certain type of amplifier is used, reference data of gain between stages is of value when trying to localize the trouble, but remember to include impedance and loading used in such a compilation.

Frequency response checks will sometimes reveal otherwise hidden characteristics. For reference it is customary to draw a curve. Take output readings at periodic points up the audio spectrum, making sure the input remains the same. Plot these points with “frequency” as abscissas and “output” as ordinates on graph paper. Semi-logarithmic, 3-cycle paper works out very nicely to 10,000 cycles which is usually far enough.

#### Conclusion

As a rule the entire unit will be grounded through the shield of the audio signal output cable to the amplifier being tested. This practice has been found satisfactory and free from spurious images. If trouble of this nature occurs the grounding between the test instruments should be made more secure. Note that no part of the “*OUTPUT MULTIPLIER +DB.*” connects to the chassis of the Gain Measuring Set. Both high and ground sides are switched. This makes it impossible to have a ground return of the output through the shield of the audio signal output cable.

The identification on the front panel was done with a 3/32” numbering and lettering set. The dial plates on the 500 ohm “T” pad and *Daven* attenuator came with the unit. The dial plates on the output multiplier came off an *IRC* attenuator. The dial plate for the output impedance selector was drawn on white paper with India ink and photographed on paper (not film). This made a paper negative which provided the white numbers on a black background. The instrument was constructed to fit into a war surplus aircraft electrical junction box. —50—

### TV SET OUTPUT RISES

**P**roduction of television receivers continued to climb during May, while radio set production, in a seasonal decline, fell below both the previous month's output and the May, 1947, total, according to latest figures released by the RMA.

May's TV receiver production by RMA member-companies totaled 50,177 for an average of more than 12,500 receivers weekly. The average weekly production of television receivers in May represented an increase of more than 38 per-cent over the average weekly production for the first quarter of 1948. May's output brought TV set production by RMA member-companies to 214,543 for the first five months of 1948 and the total manufactured since the war to more than 400,000.

Radio set production, including FM-AM and TV receivers, totaled 1,056,780 in May as against 1,182,473 in April. FM-AM set production totaled 76,435 as against 90,635 receivers of this type manufactured by RMA member-companies in April. —50—

## 30,000 SERVICEMEN READ RADIO MAINTENANCE EVERY MONTH



Leading articles cover everything for the radio serviceman on Television, FM and AM; Test Equipment; Electronic Appliances; Tools; Antennas; Alignment; Troubleshooting; Repair; Construction; Pick-Ups and Sound Amplification and Reproduction Equipment. Completely illustrated.

RADIO MAINTENANCE MAGAZINE RN  
460 Bloomfield Avenue, 9  
Montclair 6, N. J.

Please send me RADIO MAINTENANCE for  
 1 year, \$3       2 years, \$5  
 Payment enclosed       Bill me later

Name.....  
 Address.....  
 City—State.....  
 Occupation.....  
 Title.....  
 Employed by.....

ROLAND & BOYCE INC., PUBLISHERS

### SPARE PARTS CASES

Radio parts and assemblies packed in foil in wooden cases, clean and dry, “N-1.”

The government paid from \$189.76 to \$400.00 per case—YOUR PRICE, \$10.00 PER CASE, remittance in full with order.

No selection permitted, other than to guarantee up to 5 cases different, to quantity buyers.

Less than 500 cases available: we must move them without delaying for processing. Shipment by Express Collect only. (Weight, approx. 50 lbs. per case).

Laboratories, Hospitals, Universities, Public Utilities, Dealers, Hams and Experimenters—Our Surplus Stocks of instruments, equipment and parts can save you money and fulfill your requirements where commercial sources cannot. State your needs—get on our mailing list!

### ENGINEERING ASSOCIATES

Far Hills Branch Box 26R, Dayton 9, Ohio

A CAREER WITH A FUTURE!  
**TELEVISION**

SHOP WORK • SHOP TECHNIQUES • THEORY • FULLY EQUIPPED LABORATORIES

- RADIO SERVICE & REPAIR
- F. M. & TELEVISION
- TRANSMITTER COURSES

Preparing for F. C. C. LICENSES

- RADIO TECHNOLOGY

MORNING • AFTERNOON • EVENING CLASSES • MODERATE RATES • INSTALLMENTS  
 AVAILABLE UNDER G. I. BILL

**DELEHANTY SCHOOL OF  
 RADIO • ELECTRONICS • TELEVISION**  
 105 EAST 13th STREET, NEW YORK 3, N. Y. • DEPT. 5  
 LICENSED BY STATE OF NEW YORK

### FM or VIDEO I. F. COIL SET

Consists of 4 I.F. Transformers in aluminum can, 2 1/2" x 1 1/8" x 1 1/8". Frequency 20.7 Megs, permeability tuned.

A \$20 value for only \$1.49.  
 Add 20c postage.

### THOR ELECTRONICS

5051 N. Clark St., Chicago 40, Ill.

## Ham Field Day

(Continued from page 41)

supplies at any time due to the excellent performance of the larger unit during the entire 24 hour period of the test.

Various types of equipment were used during the tests, with a separate tent set up for each operating position. This separation of equipment aided greatly in reducing interference between the various rigs.

Transmitters used were of several types, ranging from home built units and converted surplus equipment, to commercially manufactured *Harvey-Wells* model TBS-50 transmitters capable of operation on any band from 3.5 to 144 mc. (See cover.)

For greatest utility in finding "holes" in the bands and to permit rapid frequency shift in the event of interference, v.f.o. units were used with several of the transmitters.

The receivers used included S-53, S-38, SX-25, SX-28 and two converted BC-348's. Several other receivers were also available for standby purposes.

Saturday morning was set aside for setting up the tents and equipment. This preparatory work was carried out in heavy rains which continued up to the starting time at 4 p.m. Fortunately, at starting time the weather cleared, and no difficulty was experienced from this source thereafter.

The problem of grub, usually requiring the time of one or two of the operators, was solved by the proximity of the Field Day location to the homes of the operators. Hot meals were prepared at home and brought out to the location and served posthaste. The net result was better meals than usually are served on Field Day, and the saving of considerable operating time.

A total of 404 stations were contacted. Ten meter phone accounted for 80 of the contacts, while 48 stations were worked on 20 meter c.w. The 40 meter position contributed a total of 163 QSO's with 75 meter phone and 80 meter c.w. added another 113 contacts.

No equipment failures were experienced and interference between stations was held to a minimum. The careful planning of frequencies to be used contributed materially to the reduction of interference.

-50-

### ANSWERS TO "RADIO QUIZ" PAGE 148

1. c	6. a	11. b	16. b
2. a	7. d	12. c	17. a
3. d	8. c	13. c	18. b
4. b	9. b	14. a	19. c
5. b	10. a	15. c	20. c

### SCORING TABLE

18 to 20 correct	.....	excellent
15 to 17 correct	.....	very good
12 to 14 correct	.....	good
9 to 11 correct	.....	fair
8 or less correct	.....	poor

# We're GILDING the LILY!

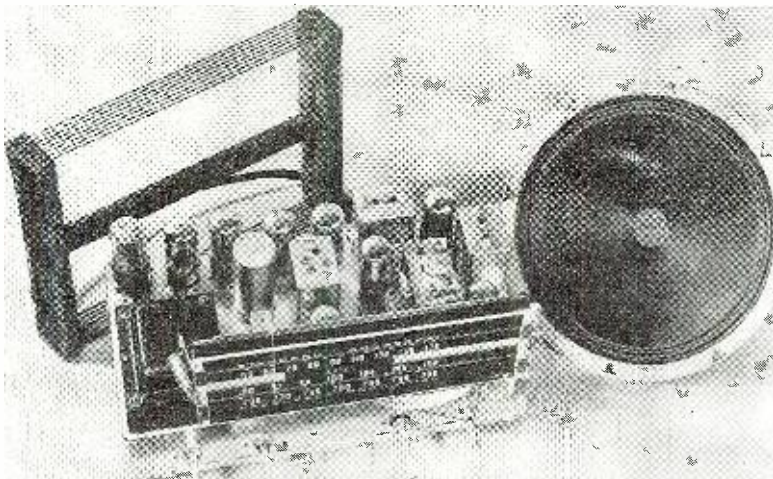

## the NEW, IMPROVED Model 7-B-1, engineered to meet YOUR needs!

Carefully engineered, and manufactured of the finest materials, the ESPEY Model 7-B-1 is specifically designed to meet the most exacting requirements for a replacement chassis, and will lend itself to any type of installation. This model is drift-compensated, AM/FM, with 10 tubes plus rectifier. Supplied complete, ready to operate.

Send to DEPT. A-9 TODAY for FREE LITERATURE

**ESPEY** MANUFACTURING COMPANY, INC.

528 EAST 72<sup>ND</sup> STREET-NEW YORK 21, N.Y.

"ESTABLISHED—1928"

### RADIO ENGINEERING DEGREE IN 27 MONTHS

Intensive, specialized course, including strong basis in mathematics and electrical engineering, advanced Radio Theory and Design, Modern laboratory. Low tuition. Self-help opportunities. Also 27-month courses in Aeronautical, Chemical, Civil, Electrical and Mechanical Engineering. Gov't approved for G.I.'s. Enter Sept., Dec., March, June. Catalogue. **INDIANA TECHNICAL COLLEGE**  
998 E. Washington Blvd., Fort Wayne 2, Indiana

**SHANEY'S**  
New **20 STEPS** to PERFECT AMPLIFICATION  
SEND 3c STAMP FOR POSTAGE  
**AMPLIFIER CORP. of AMERICA**

398-2 Broadway, New York 13 N. Y.

Every month . . . read



for the best in radio  
and electronics  
and a constant flow of  
tops - in - television  
material

# FACTORY TO YOU DIRECT!

THE NEW  
*Certified*  
TELEVISION KIT



**7" KIT** \$69.50 Less tubes—\$99.50  
with all tubes

**10" KIT** \$74.50 Less tubes, \$134.50  
with all tubes.

Money Back Guarantee—Buy it, inspect it, if you don't think it's the best buy on the market—return unused within 5 days and your money will be refunded.

All prices F.O.B. New York. 20% deposit with order  
**IMMEDIATE DELIVERY**

*Certified* TELEVISION LABORATORIES  
5507 — 13th AVE. BKLYN. 19, N. Y.

SEPTEMBER

SPECIAL

3 TUBE  
PHONO  
AMPLIFIER  
\$1.95



COMPLETELY WIRED,  
VOLUME & TONE CONTROLS

Set of 3 tubes: 50L6, 35Z5, 12A6.....	\$ 1.10
Output trans. 50L6.....	.35
1/2 Meg. vol. control with SW.....	.35
4" PM Speaker.....	.95
5" PM Speaker.....	1.15
6" PM Speaker.....	1.55
8" PM Speaker.....	2.75
12" PM Speaker.....	4.89
4x6" PM Speaker.....	1.89
Nat'l famous pickups.....	1.89
Nat'l advertised Crystals.....	1.59
Nat'l famous Motor & Turntable.....	2.50
VM #40 Intermix Changer.....	26.95

FAMOUS MAKE CONDENSERS

50x30...150v... .45	25...50v..... .29
20x20...150v... .35	16...450v..... .39
20x20 (10) 150v	400v...600v per 10
(25)..... .39	.01, .02, .05, .49
8x8...450v... .49	.001, .002, .005... .49
25...25v... .29	.1, .3, .4, .5... .59

All Prices FOB N.Y.C.—On C.O.D. 25% Dep.  
Write for Free Catalog

**THE ROSE COMPANY**

88 West Broadway, Dept. N, New York 7, N. Y.

# Manufacturers' Literature

Readers are asked to write directly to the manufacturer for the literature. By mentioning RADIO & TELEVISION NEWS, the issue and page, and enclosing the proper amount, when indicated, delay will be prevented.

## PM SUB-ASSEMBLIES

A concise 4-page illustrated booklet covering permanent magnet sub-assemblies is now available from the Metallurgy Division of General Electric Company.

The booklet describes how these magnetic sub-assemblies eliminate assembly line rejects, the high cost of test equipment, breaking and chipping losses, and the expense of shipping semi-finished magnets.

Among the sub-assemblies illustrated are the magnetic focusing sub-assembly, the magnetron sub-assembly, the cable clamp sub-assembly, a radar jammer tube, and a snap action switch.

A copy of bulletin No. CDM-16 may be secured by writing to the Metallurgy Division, General Electric Company, Pittsfield, Massachusetts.

## ELECTRO-VOICE MIKES

A 4-page condensed bulletin covering the company's line of microphones, stands, and accessories is now available from Electro-Voice, Inc. of Buchanan, Michigan.

The majority of popular E-V models are illustrated and described in this bulletin. Included in the listing are the cardioid dynamic and crystal microphones, broadcast and general-purpose dynamic and crystal microphones, carbon, dynamic, and crystal "Mobil-Mikes," differential microphones, velocity microphones, contact mikes and the low-cost multi-purpose "Century" microphones. Also included are the company's button-control floor stands, desk stands and mounts, and accessories.

A copy of Bulletin No. 103 will be forwarded upon request. Write direct to Electro-Voice, Inc., Buchanan, Michigan.

## SOLDERING GUN DATA

Weller Mfg. Co. of Easton, Pennsylvania is currently offering a concise data sheet covering the company's six soldering gun models.

Included in the bulletin is data on features, specifications, and net prices on the models S-107, D-207, ES-110, ES-220, DX-8, and DX-12.

A copy of this data sheet is available to those requesting it from Weller Mfg. Co., Easton, Pennsylvania.

## TAVERN TELEVISION

Industrial Television, Inc. has just published a free booklet entitled "What to Look for in Tavern Television" which is currently available for distribution.

The booklet outlines the special re-

quirements of television equipment used in public places. Copies may be secured from ITI dealers or direct from Industrial Television, Inc., 359 Lexington Avenue, Clifton, New Jersey.

## NEW GC CATALOGUE

General Cement Manufacturing Company of Rockford, Illinois has announced the publication of a new 64-page illustrated catalogue.

The new catalogue includes complete information on cements, chemicals, paints, finishes, cabinet repair kits, grille cloth, dial cords, dial belts, radio knobs, phono needles, switches, plugs, jacks, wire strippers, etc. for the radio, electrical, electronic, and other fields.

A copy of this catalogue is available on request. Write to General Cement Manufacturing Company, Rockford, Illinois.

## AACS STATION DIRECTORY

Publication of the second issue of the "AACS Amateur Radio Station Directory" was announced recently by Headquarters, Airways and Air Communications Service. This new directory supersedes the initial issue dated May 15, 1947 and all subsequent revisions.

The publication lists alphabetically AACS and ex-AACS amateur operators by name and station, and is cross-indexed by a simple call sign. Copies have been distributed to former AACS members who are identified further by an asterisk preceding the alphabetical listing.

Requests for copies of this directory should be addressed to: Commanding General, Airways and Air Communications Service, Washington 25, D. C., Attention A-3, Directorate of Operations.

## INDUSTRY RED BOOK

Howard W. Sams & Co., Inc. has just published the First Edition of the new "Radio Industry Red Book" which provides easy-to-use listings on all 9 major replacement components for approximately 17,000 models made during the ten year period from 1938 to 1948.

The new publication lists original parts, together with numbers for proper replacement parts made by 17 leading manufacturers covering condensers, transformers, controls, i.f. coils, speakers, vibrators, phono cartridges, tubes, dial lights, and batteries, plus installation notes covering many of these parts.

The 17 manufacturers included in

**RADIO & TELEVISION NEWS**

the "Red Book" are; *Aerovox, Astatic, Burgess, Clarostat, Cornell-Dubilier, Eveready, IRC, Jensen, Meissner, Merit, Quam-Nichols, Radiart, Solar, Sprague, Stancor, Sylvania, and Thor-darson.*

All data is arranged alphabetically and by model number for quick reference. The book contains almost 500 pages. A special binding allows the book to be opened flat on the service bench.

Copies of the "Radio Industry Red Book" are available at \$3.95 each from *Howard W. Sams & Co., Inc., 2924 East Washington Street, Indianapolis 6, Indiana.*

#### CR EQUIPMENT CATALOGUE

The *Instrument Division of Allen B. DuMont Labs., Inc.* has just issued a new catalogue which contains practical information regarding the tools of present-day oscillography—cathode-ray tubes, oscillographs, allied equipment, and accessories.

The catalogue features a wide selection of standard tubes and instruments. For a copy of the publication make your request on your business letterhead to *Instrument Division, Allen B. DuMont Labs., Inc., 1000 Main Avenue, Clifton, New Jersey.*

-30-

#### IT'S A GOOD GUESS!

**WAYNE Phelps** is richer by a \$50.00 U.S. Savings Bond because he either is a good guesser or can count electronically.

Mr. Phelps was named winner of the contest sponsored by *Hytron Radio and Electronics Corporation* at the *Radio Parts Show*. Persons attending the Show were invited to guess the number of cathode-ray sleeves in the "goldfish" bowl.

The winning guess was 7200 while the actual number of sleeves in the bowl was 7210! With a talent like that Mr. Phelps must be in big demand during inventory-time at *R.C. & L. F. Hall, Inc.* of *Houston, Texas*, with whom he is associated.

-30-

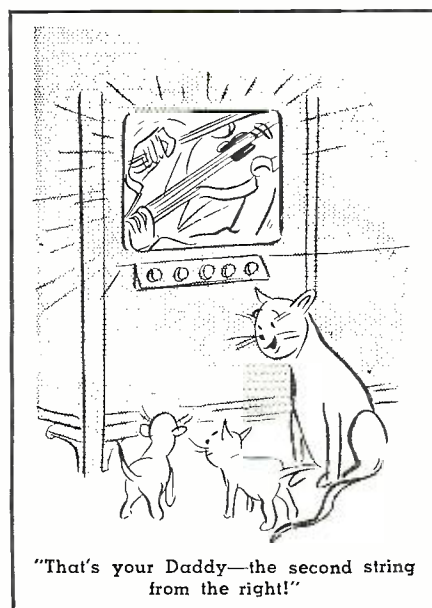

"That's your Daddy—the second string from the right!"

September, 1948

# make your henry hallicrafters headquarters

#### COMPLETE STOCKS

Henry has everything in  
the ham field

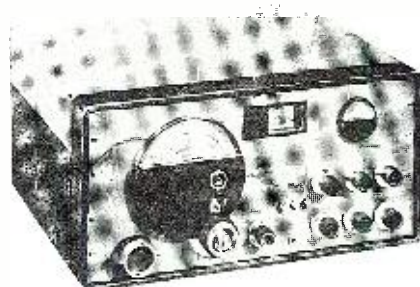
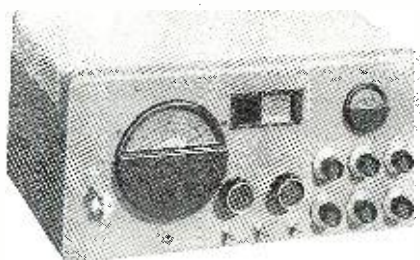

#### QUICK DELIVERY

Shipments 4 hours after receipt  
of order

**SX-43** Hottest ham performance ever at this price. All essential ham frequencies from 540 kc to 108 Mc. In the band of 44 to 55 Mc, wide band FM or narrow band AM, just right for narrow band FM reception is provided. . . . . **\$179.50**

**SX-42** Greatest continuous frequency coverage of any communications receiver—from 540 kc to 110 Mc. Six bands; AM, FM, CW. Combines in one superb unit a top-flight standard and VHF communications receiver; standard short wave and FM broadcast receiver. Finest Hallicrafters equipment. . . . . **\$295.00**

BUTLER  
MISSOURI

**HENRY RADIO STORES**

11240 Olympic Blvd.  
LOS ANGELES 25  
CALIF.

"World's Largest Distributor of Short Wave Receivers"

#### RADIO COURSES

- RADIO OPERATING • CODE
- RADIO SERVICING • ELECTRONICS
- F.M. TELEVISION
- REFRIGERATION SERVICING

Write for Catalog and Picture Brochure  
**Y. M. C. A. TRADE & TECHNICAL SCHOOLS**  
15 W. 63rd St. (N'r B'way) New York City

#### ELECTRICAL TRAINING

Intensive 32 weeks' residence course in fundamentals of industrial electrical engineering, including radio, electronics. Prepares for technician, engineering aides. Approved for veteran training. 54th year. Next classes begin Nov. 22, April 4. Catalog.

**BLISS** ELECTRICAL SCHOOL  
7698 Takoma Avenue,  
Washington 12, D. C.

#### SIGNAL CORPS JACK BOXES

TYPE BC-1366M



Each box contains Mic. Jack, Phone Jack, Volume Cont., 5 Pos. Dble. CCT, Rotary Switch, 11 Contact bayonet plug and receptacle — all mounted in 3-3/16" W x 4-3/8" H x 2-3/16" D, beautiful metal, grey enameled box.

Has many uses in the radio shack, service shop, laboratory, mobile installations, or wherever mic, phone, speaker, meter, etc., circuits are switched.

Brand new in original cartons only \$1.00 each postpaid anywhere in the U. S. Special — 6 boxes for \$5.00. Send check or money order. No C.O.D.'s.

#### ELECTRONICRAFT

5 WAVERLY PLACE TUCKAHOE 7, N. Y.  
PHONE: TUCKAHOE 3-0044

173

# NOW—A REALLY HIGH-POWERED— Radio Engineering Library

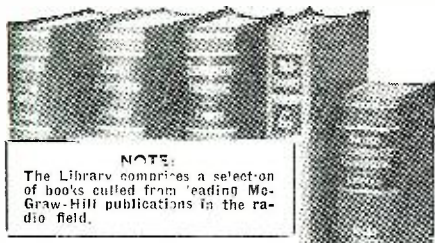

### NOTE:

The Library comprises a selection of books culled from leading McGraw-Hill publications in the radio field.

- especially selected by radio specialists of McGraw-Hill publications.
- to give most complete, dependable coverage of facts needed by all whose fields are grounded on radio fundamentals.
- available at a special price and on easy terms.

THESE books cover circuit phenomena, tube theory, networks, measurements, and other subjects—give specialized treatments of all fields of practical design and application. They are books of recognized position in the field—books you will refer to and be referred to often. If you are a practical designer, researcher or engineer in any field based on radio, you want these books for the help they give on hundreds of problems throughout the whole field of radio engineering.

**5 VOLUMES, 3559 PAGES, 2558 ILLUSTRATIONS**

1. Eastman's FUNDAMENTALS OF VACUUM TUBES
2. Terman's RADIO ENGINEERING
3. Everitt's COMMUNICATION ENGINEERING
4. Hund's HIGH FREQUENCY MEASUREMENTS
5. Henney's RADIO ENGINEERING HANDBOOK

10 days' examination. Easy terms. Special price under this offer less than books bought separately. Add these standard works to your library now! pay small monthly installments while you use the books.

**10 DAYS' FREE EXAMINATION—SEND COUPON**

**McGRAW-HILL BOOK CO., INC.**  
330 W. 42nd Street, New York 18, N. Y.

Send me Radio Engineering Library, 5 vols., for 10 days' examination on approval. In 10 days I will send \$2.50 plus few cents postage, and \$5.00 monthly till \$27.50 is paid, or return books postpaid. (We pay postage on orders accompanied by remittance of first installment.)

Name .....

Address .....

City and State .....

Company .....

Position .....

RN-9-48

*Prepare For A Good Job Now in*

# RADIO

## SOUND and TELEVISION

**LEARN QUICKLY IN  
THE GREAT SHOPS OF  
COYNE**

### NOT A "HOME STUDY" COURSE

Get ready for a better job, bigger pay NOW in Radio. Cash in with "All-around" knowledge of Radio—Sound—Television. Train on actual equipment not by "Home-study". You learn quickest at COYNE because it's a real SHOP course!

**G. I. APPROVED... also Finance Plan for NON-VETERANS.** Don't let lack of cash hold you back. Many earn while learning. FREE Employment Service to graduates. Get facts today!

**SEND COUPON FOR FREE BOOK**  
Send at once for Big Free Book on Radio, Sound and Television, and facts about our Finance Plan.

**MAIL THIS COUPON TODAY**

**B. W. COOKE, Pres.,**  
Coyne Electrical and Radio School  
500 S. Paulina St., Dept. 68-1K Chicago 12, Ill.

Please send Big FREE Book and complete details.

NAME .....

STREET .....

CITY .....

STATE .....

# Classified

Rate 20c per word. Minimum 10 words

## RADIO ENGINEERING

RADIO Engineering Broadcasting, Aviation and Police Radio, Servicing, Marine Operating and Electronics taught thoroughly. Expenses low. Write for catalog. Valparaiso Technical Institute, Dept. N., Valparaiso, Ind.

## SALE

TELEVISION Owners. We can supply you with a filter screen for reducing glare and eyestrain from your television set. A screen 7x9" costs \$2.00. All sales postpaid, cash with order. Aberdeen Auto Parts, Box 283-R, Aberdeen, Md.

PANELS for experimenters, custom builders. Gilpin, Box 638R4, Mt. Clemens, Mich.

\$4.95 IDEAL Charger for 2-volt batteries; Quantity close-out 98c; Sample \$1.75; Attractive, well-constructed. Modelectric Products, Asbury Pk., N. J.

HALLICRAFTER S-38, like new \$35. Shipped in original carton. James Coursey, 3515 W. Congress, Chicago 24, Ill.

BRUSH Soundmirror, high fidelity tape recorder like new. J. Ridgway, Milledgeville, Ill.

MAKE best offer for part or all our stock of 100 radios (4 miniature tube-superheterodyne). Moore Supply Company, Harbert, Mich.

MILLIAMPERES (10) operate electric motor and reduction gears. Runs for days on penlite batteries. Write: Harry H. Van Dick, Little Falls, N. J.

FREQUENCY Shift radio teletype receiver. Custom built with two crystal-controlled fixed-tuned receivers. Used experimentally two months by large organization. R. D. Gilmartin, 230 W. 41 St., N.Y.C. Phone Penn. 6-4000.

SHURE 707A mike. \$5.00; 708A mike with switch, \$14.95; Electrovoice V1 mike, \$20.50; Webster, Model 50 changer with base, \$25.00; Multitester, AC DC volts, DC mills, ohms 200 meg, condenser check, \$25.00. All good condition. Wayne Rawlings, Grandview, Wash.

TELEVISION Antennas. Made to order. Send sketch or estimate, prompt service. Bruce Industries, 418 Castleton Ave., Staten Island 1, N. Y.

AUDIO oscillator kit, 70-10,000 cycles. Complete parts and instructions \$9.95 less tubes. Television kit, 3" clear picture. Complete parts & instructions \$29.95 less tubes. RadioVision, Box 49, Gravesend Sta., Brooklyn 23, N. Y.

BC 375 COMPLETE with one tuning unit. Hundreds of dollars worth of parts or can be used as is, only \$20.00. J. Lester, 295 Schermerhorn St., Brooklyn, N. Y.

ALTEC Speakers, 12", 600B, special \$38.50, regularly \$45 net. Two 200C Hewlett-Packard Audio Oscillators, \$120 regularly \$145. Address: Simmonds, 518 Gonzalez Dr., San Francisco 12, Calif.

BC-348 RECEIVER, two BC-223 Transmitters and one complete SCR274N Command set; plus all needed 110 volt AC power supplies, speakers, microphones and aerial. Includes 400 pounds of Radios and Accessories. All in excellent condition. \$117.00. You pay postage. Write: Earl Williamson, 121 No. 26th Street, South Bend 17, Ind.

AIRCRAFT surplus. Sighting Stations Amplidynes, servos computers. Get list. W7RK, Everett, Wash.

WRITE Dept. RN18 for our free wholesale list of Radio parts & accessories. R. C. Radio Parts & Distributing Co., 731 Central Ave., Kansas City 6, Kans.

NEW cartoned tubes, 39c each. 1A5gt, 1C6, 1L4, 1R5, 1S5, 1T4, 3Q4, 3S4, 3V4, 5Y3gt, 6A7, 6AJ5, 6AQ6, 6AT6, 6BA6, 6BE6, 6BH6, 6BJ6, 6C5gt, 6F5gt, 6J5gt, 6K6gt, 6Q7gt, 6SA7, 6SD7gt, 6SF5gt, 6SK7gt, 6SQ7gt, 6V6gt, 6X4, 7E5, 12A6, 12F5gt, 12AT6, 12BA6, 12BE6, 12AU6, 12A8gt, 12J7gt, 12SA7gt, 12SK7gt, 12SQ7gt, 12SJ7gt, 12SH7, 12J5gt, 12SL7gt, 14J7gt, 25L6gt, 31, 32L7gt, 35B5, 35W4, 37, 38, 47, 57, 50B5, 70L7gt, 76, 89, 117L7gt, 117P7gt, 117Z3, \$0. Write for bargain flyer. Henshaw Radio Supply, 3313 Delevan, Kansas City 2, Kansas.

YOU can accurately align superheterodyne receivers without signal generator. Complete instructions. \$1. Money-back guarantee! Chas. Gates, Pecos 1, Texas.

GRILL Cloth. Celanese, light and dark pieces. 1000 square inches for \$1 bill. Write for list of lowest priced national brand parts in nation. Bursma Radio, Route 5, Grand Rapids, Mich.

SPECIFICATION & Prints of The First Successful Permanent Magnet Motor, \$10.00; plus right to make model. Send ten cents for Literature. George J. Altman, 130 Broadway, New York 7, New York.

LOWEST Prices. Radio Tubes, parts. Bargain Lists, 3c. Potter, 1314 McGee, Kansas City 6, Mo.

V.O.M. ASSEMBLY, consists of 18 wire-wound non-inductive, precision resistors mounted and fully wired on low-loss, wafer-type, rotary switch, ready to connect to your meter to make highest grade instrument. While they last, price, \$2.50. Radioco, 1110 Marshall Bldg., Cleveland, Ohio.

RME-99 Radio set with speaker, \$150. Operadio 35-50 Watt amplifier, \$150. All in good shape. Alexander Radio & Electrical Shop, Montezuma, Iowa.

FOUR G.E. 869-B rectifiers. Two 892 tripods. Slightly used. Best offer accepted. W. Smith, 2701 Seventh St., Wausau, Wis.

SUITCASE Size Radio shop-build it and double your profits. Free literature. Write: Grand Federal, 3516 Woodend, Kansas City 3, Kansas.

BC-348 RECEIVER, excellent condition, converted to A.C., \$50.00 P. Spatz, 108 Adams Place, Delmar, N. Y.

## WANTED

APR-5A, APR-4. Receivers & Tuning Units, ART-13 Transmitters, V.H.F. gear, Laboratory & Test equipment of all types. Charles Littell, Jr., 222 Lonsdale Ave., Dayton 9, Ohio.

KELLEM'S Tube Pullers #1-125 & larger. L. S. % Acme Press, 6114 Fourth Ave., Brooklyn 20, N. Y.

## HELP WANTED

INSTRUCTORS in Electronics and Radio. Prefer former Navy Radio Technician instructors willing to locate in the Detroit, Mich., area. Write to Box 452, % Radio News, 185 N. Wabash, Chicago, Ill.

WANTED: Engineers or Physicists with radar design and development experience. Also men experienced in UHF antenna design work. Master's degree or Ph.D. desired but not absolutely necessary if experience is broad enough. Reply, giving full details to Research Foundation, Oklahoma A & M College, Stillwater, Okla.

## SITUATIONS WANTED

SELECTED group of men, graduates of well-known trade school, desire employment in Radio Field. Will travel anywhere. Qualified in radio servicing, installation, test instruments, circuit operation, etc. Contact Placement Dept., Eastern Technical School, 888 Purchase Street, New Bedford, Mass.

## PATENT ATTORNEYS

LANCASTER, Allwine & Rommel, Registered Patent Attorneys. Patent practice before U.S. Patent office. Validity and Infringement investigations and opinions. Booklet and form "Evidence of Conception" forwarded upon request. Suite 414, 815 15th St., N.W., Washington 5, D. C.

## CORRESPONDENCE COURSE

LEARN Railway Telegraphy at home. Instrument furnished. Operators needed. Jobs waiting. Bell Telegraph Ry. Institute, 10 Parker Ave., San Francisco 18, Calif.

USED correspondence courses and educational books bought, sold, rented, catalog free. Educational Exchange, Summerville, Ga.

USED Correspondence courses and books bought, sold, rented and exchanged. Catalog free. Lee Mountain, Pisgah, Alabama.

AMATEUR radio licenses. Complete code and theory preparation for passing amateur radio examinations. Home study courses. American Radio Institute, 101 West 63rd St., New York 23, N. Y.

## MISCELLANEOUS

RADIOMEN, Servicemen, Beginners. Make more money, easily, quickly. \$250 weekly possible. We show you how. Information free. Merit Products, 216-32R 132 Ave., Springfield Gardens 13, N. Y.

OWNERS BC348 J K L N Q R BC224 F K H Handbook Maintenance Instructions 68 pages. \$1.75 Postpaid in U.S. Remit postal note. W4NVG 2 Depot Place, Glen Head, N. Y.

BRITISH radio developments. Experts in Britain are producing many new ideas. Details of these advances, fully explained by leading technicians are included regularly in Foremost British radio monthly, Practical Wireless. Features include constructional details, help and advice clubs, and much of unique interest to both amateur and serviceman export. Read everywhere by enthusiasts who wish to "keep ahead" in International trade or amateur DX field. Rush order now. For annual subscription mailed direct from London, send only \$2.00 to George Newnes Ltd., (FW.20), 342 Madison Avenue, New York 17, N. Y.

BC-454 or 455 easily converted to hot ten meter receiver. Fixed or mobile. Instructions, schematics, \$1. N. Brown, 3327 Geronimo, Tucson, Ariz.

## RADIO & TELEVISION NEWS

## NEW SERIES OF TOWN MEETINGS SCHEDULED FOR 1948-49

THE first of a series of five educational meetings for radio technicians in the next twelve months will be held at the Hotel Astor on September 27, 28, and 29, according to the announcement made by Harry A. Ehle, Chairman of the Town Meetings Committee of the Radio Parts Industry Coordinating Committee.

The New York meeting will be followed by one in Boston at the Hotel Bradford, November 15, 16, and 17, and by others in Atlanta (January), Los Angeles (March), and Chicago (April).

All will be adaptations of the program worked out for the first Town Meeting of Radio Technicians, held in Philadelphia last January as the first attempt on the part of the radio industry to extend a helping hand to the radio serviceman. As in Philadelphia each of the meetings will be completely non-commercial.

Cooperation of set as well as parts distributors is expected in each city, according to Mr. Ehle. National expense of staging and arranging the meetings will be borne by the Coordinating Committee and, as in Philadelphia, local distributors will be asked to bear the cost of promotion, meeting place, and similar expenditures.

The Coordinating Committee is composed of representatives from the Electronic Parts and Equipment Manufacturers, Radio Manufacturers Association, The Sales Managers Club (Eastern Division) and the West Coast Electronic Manufacturers Association. —30—

## DELTA DIVISION CONFAB

SEPTEMBER 17, 18, and 19th will find many of the Gulf Coast amateurs assembled in Biloxi, Mississippi to attend the Delta Division ARRL Convention being held at the Buena Vista Hotel.

The Gulf Coast Radio Club is acting as sponsors for this affair and has planned an elaborate and interesting program for hams, XYL's, commercial radiomen, servicemen, manufacturers, sales personnel, and distributors.

Among the speakers at the convention are Oliver Read, W9ET1, Editor of RADIO & TELEVISION NEWS, and George K. Rollins, W3GA, FCC Chief of the Radio Operator & Amateur Division, Washington, D. C.

Through the courtesy of Maj. General C. W. Lawrence, Saturday morning has been designated as "open house" day at Keesler Air Force Base, where conventioners will be allowed to inspect the various types of radar equipment in use at the base.

Reservations for the affair should be made with Gulf Coast Radio Club, Box 283, Biloxi, Mississippi. —30—

## PHOTO CREDITS

Pages	Credit
35, 36, 37	DeMornay Budd, Inc.
40	Color Television, Inc.
42, 44	Taylor Transmitters
45, 47	Walter Steinhard
48	Cinaudagraph Speakers
54, 55, 56	Federal Telephone & Radio Corporation
58	RCA Service Corp.
60	Station PCI, Hilversum
72	Great Lakes Steel Corporation
84	Bell Telephone Laboratories
102	Acme
110	Hylton Radio & Electronics Corp.
132	Columbia Records, Inc.
140	Radio Corporation of America

## THE FASTEST TV ANTENNA ASSEMBLY

**YOU + JFD "QUIK-RIG" = 30 SECONDS!**

*As Simple  
As Opening  
An Umbrella*

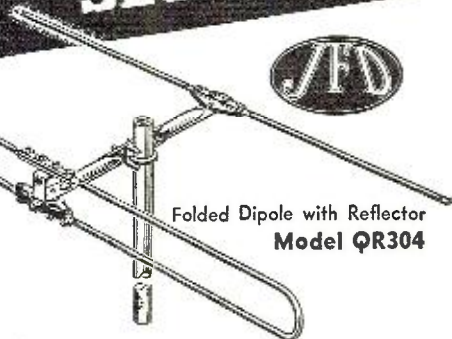
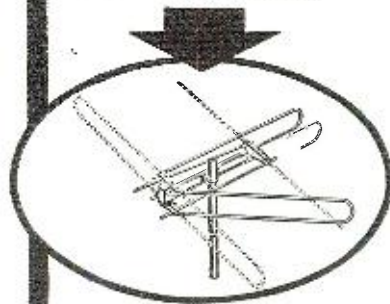

Folded Dipole with Reflector  
Model QR304

- ★ The simplest — fastest — easiest antenna assembly on the market today!
- ★ Completely pre-assembled.
- ★ No special tools or knowledge required.
- ★ Cuts installation time to the bone.

JFD Super-Beam Quik-Rig Antennas are available in a wide range of models to fit all requirements. Write for complete Quik-Rig catalog.

Ask your jobber to show you the new JFD Quik-Rig Antenna line.

**JFD MANUFACTURING CO. Inc.**

4109 FT. HAMILTON PARKWAY, BROOKLYN 19, N. Y.



## Brand New WESTERN ELECTRIC

35 Watt Driver Unit

Orig. Govt. Cost  
\$40.00

8 ohm voice coil will handle up to 55 watts

4 1/4" long  
4 1/4" wide  
2 3/4" deep

Built to the highest standards of electrical and mechanical tolerances to insure peak efficiency and perfect alignment for greater efficiency. A breakdown proof diaphragm of plastic replaces the old metal type. Completely impervious to climatic changes and corrosion.

### FULL FREQUENCY RESPONSE

The most rugged unit ever built, shock-proof construction can be used as tweeter with your Woofer or as a driver with your own projector. Outdoors or in. In lots of 10 . . . . . \$49.50

**\$595**

Each

## Brand New GENERAL ELECTRIC AMPLIDYNE

Govt. Cost \$118.00

Manufactured for U.S. Air Forces  
Input 27V DC Output 60V 530 Watts

Shaft App. 1" — Dia. 1/2" Air cooled by removable fan. Unit measures 11 3/4" x 5 1/2". Brand New In sealed cartons.

**\$995**

SPECIAL F.O.B. N.Y.C.

**A WIRE BUY!!!**  
No. 15-7 S T P and Black Plastic Vinylite indoor or outdoor wiring. O.D. 1/8" on 27" reel, 15000 feet . . . . . \$270.00 value—Lifetime covering—100 lists.

**\$3000**

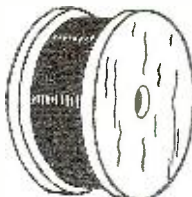

25% DEPOSIT WITH ORDER—BALANCE C.O.D.

**MANUEL KLEIN**

74 Cortlandt St. New York 7, N. Y.

## CUT HOLES 1/2" to 3 1/2" IN RADIO CHASSIS



WITH A GREENLEE RADIO CHASSIS PUNCH

● Save hours of work . . . no reaming or tedious filing. Punch cuts through chassis quickly . . . makes accurate, clean holes for sockets, plugs, and other receptacles. Just turn with an ordinary wrench. There's a GREENLEE Punch in each of these sizes: 1/2"; 5/8"; 3/4"; 7/8"; 1"; 1 1/16"; 1 1/8"; 1 1/4"; 1 1/2"; 1 5/8"; 1 3/4"; 1 7/8"; 1 1/2"; 2 1/4". Write for complete facts. Also get information on Knockout Punches and Cutters for conduit and meter holes up to 3 1/2". Greenlee Tool Co., 1889 Columbia Avenue, Rockford, Illinois.

TOOLS FOR CRAFTSMEN

**GREENLEE**



**AND WE EXPECTED A REST THIS SUMMER!**

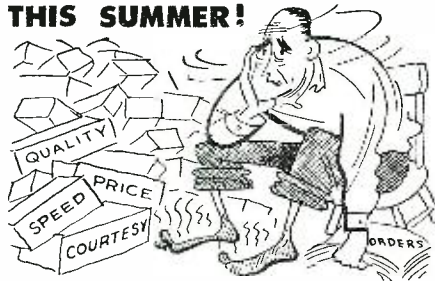

Busy? We filled so many orders this summer, we hardly had time to mop our brow. In fact, we've just got enough strength to announce these brand new, low-cost specials and tell you to get 'em while we got 'em. before falling flat on our face.

**HIGH FREQUENCY SETS**

**RT-7/APN-1 RADAR ALTIMETER.** Transmitter-receiver, 418 to 462 M.C. F.M. complete with 14 tubes, 24 volt dynamotor, etc. This unit can easily be converted to the 420 M.C. amateur or the 460 to 470 M.C. citizen's bands.

BRAND NEW, in original cartons. **\$10.00**

**R89/ARN-5A GLIDE PATH RECEIVER.** 332 to 335 M.C. A.M. receiver. Includes 11 tubes, 3 relays, 3 crystals, 90 and 150 cycle audio filters, etc. **SCHEMATIC. BRAND NEW \$7.50** in original cartons.

**BC-733D LOCALIZER RECEIVER.** 108 to 110 M.C. A.M. receiver. Includes 10 tubes, 6 relays, 6 crystals, 90 and 150 cycle audio filters, etc. **SCHEMATIC.** Easily converted to the two meter amateur, taxi cab, mobile and police bands. Will also make a dandy receiver on the new F.M. band, crystal controlled oscillator, no drift. **BRAND NEW \$7.50** in original cartons.

**Write for FREE circular**

Prices are F.O.B. our warehouse CHICAGO. Subject to prior sale. 20% minimum with order, balance C.O.D. Illinois deliveries add 2%.

**QUAD ELECTRICAL SUPPLY, INC**  
1650 North Damen Avenue, Chicago 47, Illinois

**Abolish QRM!**

• Make your BC-342 or BC-348 into a real SINGLE SIGNAL job — or make your topflight communications receiver a 1949 model—with the audio filter described by W2-ESO in JUNE CQ or send for hookup.



\$3.45 ea.

• We have the filter in its used in both models. A Real Value for the Phone Man, DX Hound or Traffic Man!!!



**POWER RHEOSTAT—50 watt, 1.1 ohm. W/Knob and switch. Control; Hi-current, LO-Voltage sources. New—Each 95c 3 for...\$2.50**

**LITTLEFUSE—Fuse extractor Post.** Finger operated knob #442002; complete with all hardware; New List \$3.50 each.



Our price..... 3 for **\$1.00**  
Pulse XFormer—P.O. AN/APS-13; 3 for **\$1.00**  
Blocking OSC Transformer—P.O. AN/APS-13; ..... 2 for **\$1.00**

**CATHODE RAY DEFLECTION COIL KIT.** Includes bakelite housing, Phenolic drum, brass plate, 2 deflection coils (1 spare) and instruction sheets.



New **\$1.50** each 4 for **\$5.00**

**New Bulletin off press—write GREENWICH SALES CO.**  
59 Cortland St.  
New York 7, N. Y.

**INDEX OF Advertisers**

SEPT 1948

ADVERTISER	Page No.
A. M. Radio Sales Co.....	168
Abell Distributing Co.....	112
Aeron Electronics Corp.....	154
Aero Parts Supply.....	151
Air King Radio, Division of Hytron Radio & Electronic Corp.....	25
Allied Radio Corp.....	9
Almo.....	116
Alvaradio Supply Co.....	88, 166
American Radio Institute.....	158
American Sales Co.....	142
American Surplus Products Co.....	99
American Television and Radio Co.....	137
Amperite Co.....	177
Amplifier Corp. of America.....	145, 156, 165, 171
Arrow Sales, Inc.....	94, 95
Ashe Radio Co., Walter.....	30
Atlas Sound Corp.....	18
Audel Publishers.....	72
Audiview Radio Parts Co.....	130
Audio Development Co.....	96
Baltimore Technical Institute.....	166
Band-It Company, Inc.....	166
Belden Mfg. Co.....	33
Bell Telephone Laboratories.....	24
Bendix Radio.....	21
Berman Co., Inc., Henry O.....	146
Bliss Electrical School.....	173
Boland & Boyce Inc., Publishers.....	70, 88, 112, 170
Bradshaw Instruments Co.....	147
Brook Electronics Co.....	141
Brooks Radio Dist. Corp.....	135
Burlington Instrument Co.....	110
Burstein-Applebee Co.....	127
Buyers Syndicate.....	106
Cal-Perry Corp.....	138
Candler System Co.....	167
Cannon Electric Development Co.....	170
Capitol Radio Engineering Institute.....	31, 89
Centralab, Division of Globe Union, Inc.....	12, 13
Certified Television Laboratories.....	160, 172
Chicago Industrial Instrument Co.....	126
Chicago Transformer, Division of Essex Wire Corporation.....	27
Cinaudagraph Speakers, Division of Aireon Mfg. Corp.....	145
Clearvue File Co.....	136
Cleveland Institute of Radio Electronics.....	34
Collins Audio Products Co., Inc.....	141
Columbia Electronics.....	153
Columbia Wire & Supply Co.....	177
Commercial Radio.....	166
Commercial Radio Institute.....	114
Communications Equipment Co.....	129
Coradio.....	159
Cortley Television Corp.....	104
Coyne Electrical & Radio School.....	84, 174
Crystal Devices Co., Inc.....	149
Custom Plastics.....	162
Davis Development Co.....	162
DeForest's Training, Inc.....	19
Delehanty School of Television.....	170
Dow Radio.....	118, 150
Duotone Company.....	163
East Coast Radio of Florida.....	142
Electronic Instrument Co., Inc.....	130
Electronic Sales Co.....	139
Electronic Supplies.....	149
Electroncraft Inc.....	173
Electronics Institute, Inc.....	100
Emmons Radio Supply.....	78
Engineering Assoc.....	170
EPCO.....	158
Ereco (Dick Rose).....	164

ADVERTISER	Page No.
Esgee Sales Co., Ltd.....	154
Espey Mfg. Company, Inc.....	171
Esse Radio Company.....	117
Fair Radio Sales.....	150
Federal Telephone & Radio Corp.....	6
Federated Purchaser, Inc.....	132
Feiler Engineering Company.....	137
Foto-Radio Co., Inc.....	122
Franklin-Ellis Co.....	133
Freed Transformer Co., Inc.....	104
G & G Radio Parts Service.....	121
General Cement Mfg. Co.....	163
General Electric Company.....	11, 22, 71
General Electronic Distributing Co.....	93, 157
General Test Equipment.....	161
Goodheart, R. E.....	130
Greenlee Tool Co.....	175
Greenwich Sales Co.....	176
Greylock Electronic Supply Co.....	114
Hallcrafters Radio Co., The.....	5
Harvey Radio Company, Inc.....	26
Heath Company, The.....	86, 87
Henry Radio Stores.....	173
Herbach & Radman, Inc.....	136
Hollywood Sound Institute.....	177
Hytron Radio & Electronics Corp.....	83
Indiana Technical College.....	171
Industrial Television, Inc.....	163
Instructograph Company.....	70
Instrument Associates.....	114
International Electric Co.....	78
JFD Mfg. Co., Inc.....	175
James Vibrapower Co.....	169
Jensen Industries.....	157
Jensen Mfg. Co.....	77
Jerrold Electronics, Inc.....	102
Johnson Company, E. F.....	114
Joseph, Irving.....	105
Klein, Manuel.....	175
LaFayette-Concord.....	103
LaPointe Plascomold Corp.....	198
Leeds Radio Co.....	125
Leotone Radio Co.....	146, 167
Lincoln Engineering School.....	159
Long Island Radio Co.....	134
Mallory & Co., Inc., P. R.....	Third Cover
Marino Radio Co.....	153
Marco Electronics, Inc.....	110
Martin School of Radio Arts, Don.....	151
Maryland Distributors.....	161
Mass. Radio School.....	156
Melville Radio Institute.....	158
Mid-America.....	156
Midwest Radio & Television Corp.....	111
Midway Sales Co.....	160
Milwaukee School of Engineering.....	160
Morts Radio Shack.....	88
Moss Electronic Distributing Co.....	119
Motor Industries Co.....	159
Murray Hill Books, Inc.....	161
McGee Radio Company.....	73, 74, 75
McGraw-Hill Book Company, Inc.....	174
Nation Wide Radio.....	128
National Equipment & Supply Co., Inc.....	131
National Radio Institute.....	3
National Schools.....	23
Newark Electric Company, Inc.....	159
Newark Surplus Materials Co.....	78
Newcomb Audio Products Co.....	28
Niagara Radio Supply Corp.....	97
Northwestern Vocational Institute.....	166



ADVERTISER	Page No.
Offenbach & Reimus Co.	82
Ohmite Manufacturing Company	29
Onan & Sons, D. W.	169
Opad-Green Company	143
Peak Electronics Co.	124
Peerless Electrical Products, Division of Altec Lansing	110
Phileo Radio	14
Photocon Sales	111
Potter Radio Company	150
Power Conversion Corp.	136
Precision Apparatus Co.	28
Premax Products	120
Progressive Electronics Co.	167
Quad Electric Supply	138
Quam Nichols Company	162
R.C.A. Institutes, Inc.	161
R.-L. Electronic Corporation	104
R & M Radio Company	90, 91
Radiart Mfg., The	69
Radio Corporation of America	17
Radio Craftsmen, Inc., The	153
Radio Ham Shack, Inc.	80, 81
Radio Kits Company	146
Radio Parts Company	145
Radio Products Sales	156
Radio Supply & Engineering Co.	140
Radiomart, Inc.	70
Radionic Equipment Co.	98
Rauland Corp., The	137
Ravac Electronics Corp.	116
Raytheon Mfg. Co.	113
Renner Associates, Richard	98, 106
Rider Publisher, Inc., John F.	10
Rose Company	172
Sams & Company, Inc., Howard W.	15, 147
Schulz's Radio Parts	154
Seuco Radio, Inc.	115, 148
Servo-Tek Products Co.	151
Shure Brothers, Inc.	20
Smith, Wardell	118
Spellman Television Co., Inc.	107
Sprague Products Company	85
Sprayberry Academy of Radio	7
St. Louis Microphone	158
Stahl, Inc., Michael	122
Standard Radio & Electronic Products Co.	133
Sun Radio of Washington D. C.	144
Supreme Publications	32
Sutton's Wholesale Electronics, Bill	112
Sylvania Electric Products, Inc. Fourth Cover	
TAB	109
Tallen Co., Inc.	126
Tape Tone Mfg. Corp.	134
Technical Radio Parts Co.	134
Tel-Craft Co.	118
Telemarine Communications Company	142
Television Assembly Co.	Second Cover
Television Laboratories, Inc.	138
Telex, Inc.	155
Thor Electronics	170
Transvision, Inc.	123, 149
Tri-State College	167
Triplett Electrical Instrument Co.	178
Troup Engineering Co.	151
Turner Company, The	101
United Surplus Materials	100
Universal General Corp.	160
Valparaiso Technical Institute	165
Ward Leonard	165
Ward Products Corporation, The, Division of The Gabriel Company	79
Weber Electric	122
Weller Manufacturing Co.	8
Wells Sales, Inc.	16
Western Radio Communications Institute	98
Wholesale Radio Parts Co., Inc.	160
World Radio Laboratories, Inc.	106
Workshop Associates Incorporated	116
YMCA Trade & Technical Schools	173
Zack Radio Supply	165

# AMPERITE

## Studio Microphones at P.A. Prices

Ideal for BROADCASTING  
 • RECORDING  
 • PUBLIC ADDRESS

"The ultimate in microphone quality," says Evan Rushing, sound engineer of the Hotel New Yorker.

- Shout right into the new Amperite Microphone—or stand 2 feet away—reproduction is always perfect.
- The only type microphone that is not affected by any climatic conditions.
- Guaranteed to withstand more "knock-around" than any other type mike.

**Special Offer:** Write for Special Introductory Offer, and 4-page illustrated folder.



Models  
 RBLG—200 ohms  
 RBHG—Hi-imp.  
 List \$42.00



"Kontak" Mikes  
 Model SKH, list \$12.00  
 Model KKH, list \$18.00

**AMPERITE Company, Inc.**

561 BROADWAY • NEW YORK 12, N. Y.

In Canada: Atlas Radio Corp., Ltd., 560 King St. W., Toronto

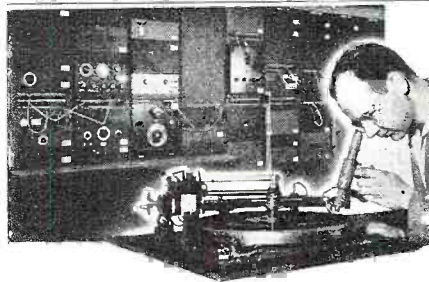

### School of SOUND RECORDING, TRANSMISSION ENGINEERING, RADIO-TELEVISION

Learn sound recording and transmission engineering techniques of the professionals, as used in Motion Picture, Broadcast, F-M, Television, and Commercial Recording Studios.

A practical engineering course, devoted to the technique of sound recording and transmission measurements. Well equipped studios, professional recorders and circuit laboratory containing latest model test equipment installed for student training. A portion of our laboratory is pictured above.



H.W. Theraime  
 Director

WRITE FOR LITERATURE

HOLLYWOOD SOUND INSTITUTE, Inc.  
 1040-N No. Kenmore, Hollywood 27, Calif.

## Columbia AERIAL KITS

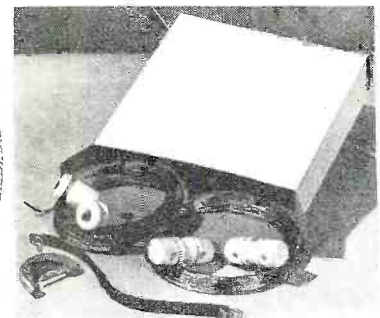

We are introducing a new low cost, high quality, aerial kit that we believe is one of the finest values we have ever offered. Compare our kit with any other and you will be convinced.

Kit consists of 100 ft. 7/27 bare copper antenna wire, 50 ft. of 18 ga. all copper, rubber insulated, lead-in wire, 2 porcelain insulators, 2 nail-it knobs, heavy-duty, cadmium plated ground clamp, 10 1/2 inch, high gloss, well insulated lead-in strip, all contained in a 9x9x2 heavy cardboard box. A real buy.

Minimum Order 3 Kits **75c ea.**

### 2 Conductor Microphone Cable

20 ga. extra flexible conductors, tinned copper shield and rubber jacket overall. Capacity between conductors approximately 37 MMF.

100 ft. coil ..... \$ 5.50

500 ft. spool ..... 26.25

Send for sensational warehouse clearance listings of never-to-be duplicated bargains in wire, cord and cable.

See your local jobber or write direct.

**COLUMBIA WIRE & SUPPLY CO.**  
 5734 ELSTON AVE.  
 CHICAGO 30, ILLINOIS



# UP and DOWN

## Lever Switching Connects Each Tube Pin to Proper Circuit

- 1. ALL ELEMENT CHECK** — Thorough conclusive test of tube elements, shields and taps. The only commercial tester to get at each tube pin and make an open and short check.
- 2. NO HUNTING FOR SOCKETS** — No plugging into wrong socket. Circuit flexibility requires only one socket for each type of tube base.
- 3. CIRCUIT CLARITY** — Lever switch numbering corresponds to RMA tube pin numbers, connected to bring out each active tube element. A simple up or down motion of the lever instantly makes the connection.
- 4. OPERATION SIMPLICITY** — Minimum of control settings plus straightforward arrangement of this outstanding emission circuit. Generally not more than five of the 10 lever switches need be set.
- 5. "PICTURE" YOUR CIRCUIT** — Assures confidence in tests and enables special tube checks for balanced circuits, special loads, etc. "Trick" switching circuits make it more difficult for the serviceman to "picture" his test circuit.
- 6. SET UP YOUR OWN TEST FOR NEW TUBES** — The "pictured" circuit and straightforward test procedures enable the user to set up data for new tubes. A feature rarely found in commercial type tube testers.
- 7. INDIVIDUAL CONTROL FOR EACH TUBE ELEMENT** — Takes care of roaming elements, dual cathode structures, multi-purpose tubes, etc., in addition to standard value tests.

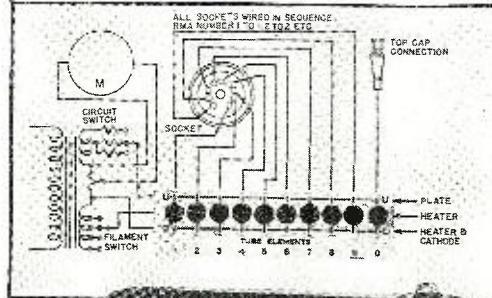

### TUBE TESTER MODEL 3413

Triplet lever switching circuit arrangement has 7 distinct advantages contributing to maximum flexibility, simplicity of operation and anti-obsolence.

**NET DEALER PRICE \$6075**



*SOLVE YOUR SERVICE PROBLEMS BETTER . . . WITH TRIPLETT*



Model 3433

F.M.-A.M. Signal Generator  
U.S.A. Dealer Net . . . \$157.50

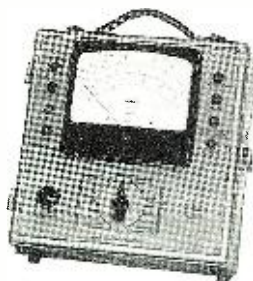

Model 2405-A

Sensitive Volt-Ohm-Mil-Ammeter.  
U.S.A. Dealer Net . . . \$54.75



Model 625-NA

Wide Range Volt-Ohm-Mil-Ammeter. U.S.A.  
Dealer Net . . . . . \$45.00

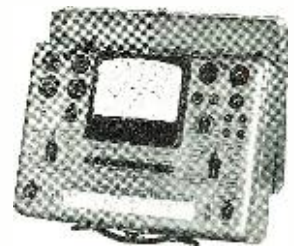

Model 3480

Combination Tube Tester—  
Volt-Ohm-Mil-Ammeter U.S.  
A. Dealer Net . . . . . \$89.75

*Precision first...to Last*



**TRIPLETT ELECTRICAL INSTRUMENT COMPANY • BLUFFTON, OHIO, U.S.A.**

*In Canada: Triplet Instruments of Canada, Georgetown, Ontario*

*All New!*

# Mallory Midgetrol

*Revolutionary*

The  
First

$15\frac{1}{16}$ "

Replacement  
Control  
Line

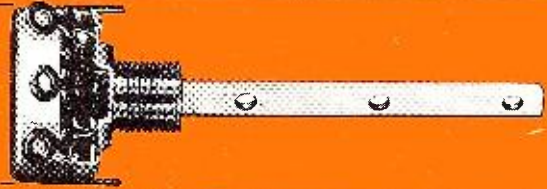

Quietest and Smoothest . . . by Test!

**THE SIZE IS . . . . . NEW**

Only  $15\frac{1}{16}$ " in diameter, it easily services the increasingly popular small sets where ordinary controls will not fit.

**THE SWITCH IS . . . . . NEW**

No chance of failure—it's Mallory engineered and Mallory manufactured. Pushes on—stays on—and *works*.

**THE DESIGN IS . . . . . NEW**

Brand new shaft style saves valuable time in installation—reduces inventory since one shaft fits all knobs.

**THE ELEMENT IS . . . . . NEW**

More accurate over-all resistance, smoother tapers, ample power dissipation.

**THE CONSTRUCTION IS . . . . . NEW**

Extra quiet—no metal-to-metal contact between shaft and cover or bushing. Special Mallory contact material.

**THE CONTACT IS . . . . . NEW**

Laboratory tests prove that the Mallory Midgetrol is the quietest control on the market.

**THE SHAFT IS . . . . . NEW**

Unique—two simple fittings—for all type knobs. No need for extra controls for different knobs.

**THE TERMINAL IS . . . . . NEW**

Won't break—twist 'em all you want in close working space. Away from panel to avoid shorting.

**THE EXTENSION IS . . . . . NEW**

Easy to apply with self-tapping screws. Supplementary shafts available for installations which require them.

**THE SUSPENSION IS . . . . . NEW**

Two-point—insures even contact pressure at all points of rotation. Larger bushing area—added support—no wobble.

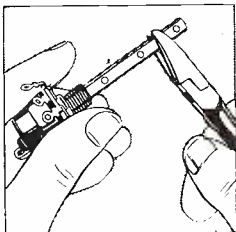

Side snips neatly cut shaft to length desired.

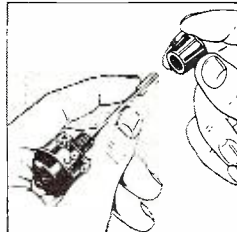

U-clip furnished to slide over end of shaft—holds set-screw knobs.

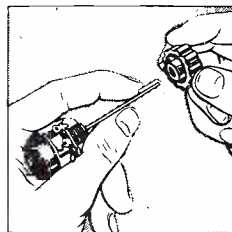

Use half the U-clip to hold push-on type knobs.

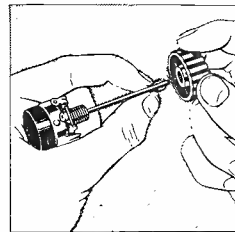

Spring steel clip included for use with knurled knobs.

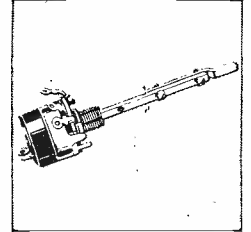

Extension shafts with two self-tapping screws available when needed.

*It's the NEW Standard in Carbon Controls. See your Mallory distributor.*

P. R. MALLORY & CO., INC.  
**MALLORY**

CAPACITORS • CONTROLS • VIBRATORS • SWITCHES • RESISTORS  
• RECTIFIERS • VIBRAPACK® POWER SUPPLIES • FILTERS

®Reg. U. S. Pat. Off.

**APPROVED PRECISION PRODUCTS**

**P. R. MALLORY & CO., Inc., INDIANAPOLIS 6, INDIANA**

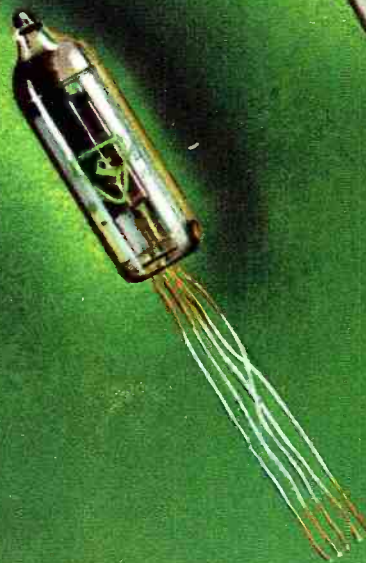

**THE RECEIVING TUBES  
YOU WANT WITH THE**

*Quality  
you expect!*

Whether your manufacturing or replacement requirements call for Lock-Ins, miniatures, sub-miniatures or standard glass radio receiving tubes, you can count on the Sylvania line for lastingly high-quality performance.

Sylvania Tubes are selected by leading makers of AM, FM and TV receivers . . . preferred by servicemen . . . enthusiastically endorsed by set-owners. See your Sylvania Distributor, or write Radio Tube Division, Emporium, Pa.

**SYLVANIA**  
  
**ELECTRIC**

RADIO TUBES; CATHODE RAY TUBES; ELECTRONIC DEVICES; FLUORESCENT LAMPS, FIXTURES, WIRING DEVICES; ELECTRIC LIGHT BULBS; PHOTOLAMPS